

# TABLE OF CONTENTS

---

Propeller Basics	A2
Propeller Characteristics	A3 - A4
Determining RPM	A5
About Michigan Match™ Propellers	A6
About Rapture™ Propellers	A7
About Ballistic™ Propellers	A8
About Vortex™ Propellers	A9
About Rapture XHS™ Propellers	A10
Ski and Tow Boat Propellers	A11 - A13
How to Use This Book	A14

## PROPELLER CROSS REFERENCE

Michigan Wheel Alpha-Numeric Cross Reference	B2
OEM Cross Reference	B3 - B35
XHS™ Hub System to Mercury Flo-Torq II® Hub System Cross Reference	B35
Michigan Match™ to XHS™ Cross Reference	B36
Rapture™ to XHS™ Cross Reference	B37 - B38

## OUTBOARD PROPELLERS - APPLICATION GUIDE

Evinrude, Johnson Outboards	2 - 9
Force, Chrysler, U.S. Marine Outboards	10 - 13
Honda Outboards	14 - 17
Mercury, Mariner, Sea Ray Outboards	18 - 23
Nissan/Tohatsu Outboards	24 - 25
Suzuki Outboards	26 - 28
Yamaha Outboards	29 - 33

## STERNDRIVE PROPELLERS - APPLICATION GUIDE

MerCruiser Sterndrives	35 - 39
OMC/Outboard Marine Sterndrives	39 - 46
Volvo Sterndrives	47 - 48
Yamaha Sterndrives	49
XHS Propeller Accessories	50 - 51
Michigan Wheel Warranty	52

# PROPELLER BASICS

## Diameter

Diameter is two times the distance from the center of the hub to the tip of the blade. It also can be looked at as the distance across the circle that the propeller would make when rotating. It is the first number listed when describing a propeller.

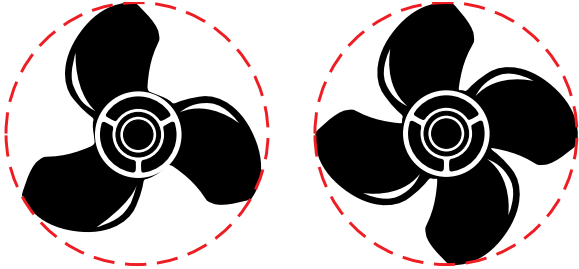

## Pitch

Pitch is defined as the theoretical forward movement of a propeller during one revolution — assuming there is no “slippage” between the propeller blade and the water. For most boats, there is slippage and therefore the distance advanced is less than the design pitch. The amount of slippage varies from boat to boat. Pitch is the second number listed in the propeller description.

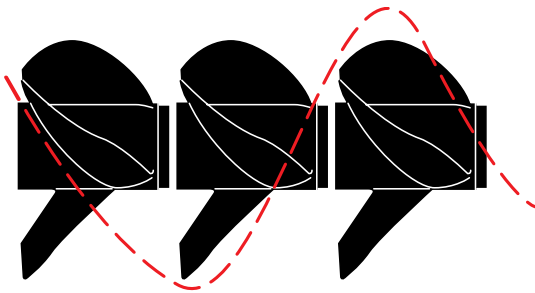

## Cupping

Many of today’s propellers incorporate a cup at the trailing edge of the propeller blade. This curved lip on the propeller allows it to get a better bite on the water. This results in reduced ventilation, slipping, and allows for a better hole shot in many cases. A cupped propeller also works very well where the motor can be trimmed so that the propeller is near the surface of the water. The cup will typically result in higher top end speed on one of these applications.

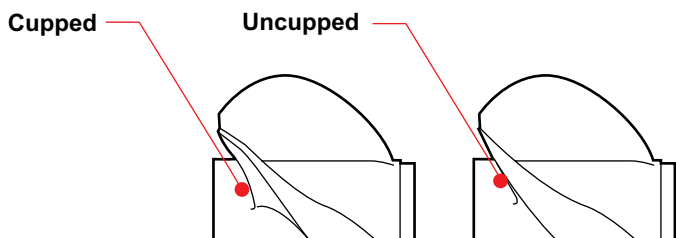

## Rake

Rake is the degree that the blades slant forward or backwards in relation to the hub. Rake can affect the flow of water through the propeller, and has implications with respect to boat performance.

Aft Rake helps to trim the bow of the boat upwards, which often results in less wetted surface area and therefore higher top end speed. Aft rake propellers also typically “bite” better on ventilating type applications.

Forward, or negative rake, helps hold the bow of the boat down. This is more common in workboat type applications.

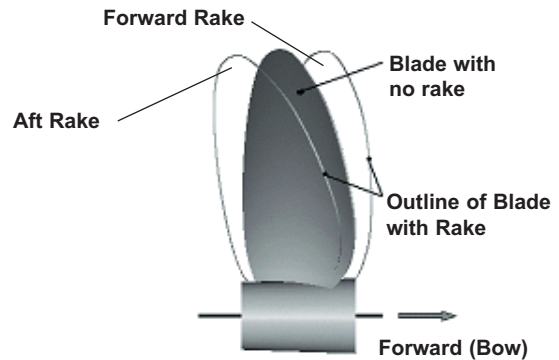

## Ventilation

Ventilation is a situation where surface air or exhaust gasses are drawn into the propeller blades. When this situation occurs, boat speed is lost and engine RPM climbs rapidly. This can result from excessively tight cornering, a motor that is mounted very high on the transom, or by over-trimming the engine.

## Cavitation

Cavitation, (which is often confused with ventilation), is a phenomena of water vaporizing or “boiling” due to the extreme reduction of pressure on the back of the propeller blade. Many propellers partially cavitate during normal operation, but excessive cavitation can result in physical damage to the propeller’s blade surface due to the collapse of microscopic bubbles on the blade.

There may be numerous causes of cavitation such as incorrect matching of propeller style to application, incorrect pitch, physical damage to the blade edges, etc...

Be advised disturbances in the water flow forward of the propeller can result in blade damage which appears to be blade cavitation, but is actually due to non-favorable water flow into the propeller.

# PROPELLER CHARACTERISTICS

Finding the right match between the propeller, engine type and boat size will optimize the following performance factors — increased top end, faster planing speed, improved low end punch and load carrying capability.

If you want to modify your boat's performance, consider the following before making your selection.

## 3 blades ... or 4?

We recommend 3-blade propellers for recreational boats with 3, 4, and 6 cylinder outboards and I/O engines. These propellers provide good "hole shot" and top-speed performance.

We recommend 4-blade propellers for bass boats and boats with high performance hulls running high horsepower outboard engines. Compared to 3 blades, they provide better "hole shot" performance with less steering torque and less vibration at high speeds.

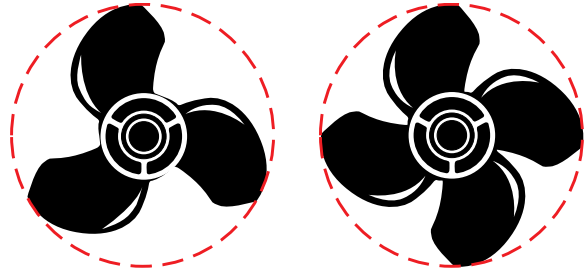

## What's the advantage of a left-hand prop?

Two propellers spinning the same direction on twin engine boats will create steering torque. In other words, two right-hand propellers pull the stern hard to the right and the bow to the left.

Two opposite-direction propellers on twin engines eliminate this steering torque because the left-hand propeller balances out the right-hand propeller. This results in better straight-line tracking and helm control at high speed.

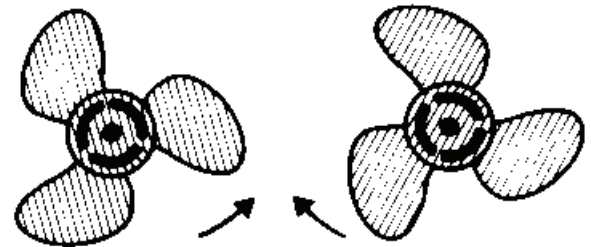

## How does wheel diameter, pitch, and slip affect performance ... and how is it measured?

Slip is the difference between actual and theoretical travel of the propeller blades through water. A properly matched propeller will actually move forward about 80 to 90 percent of the theoretical pitch.

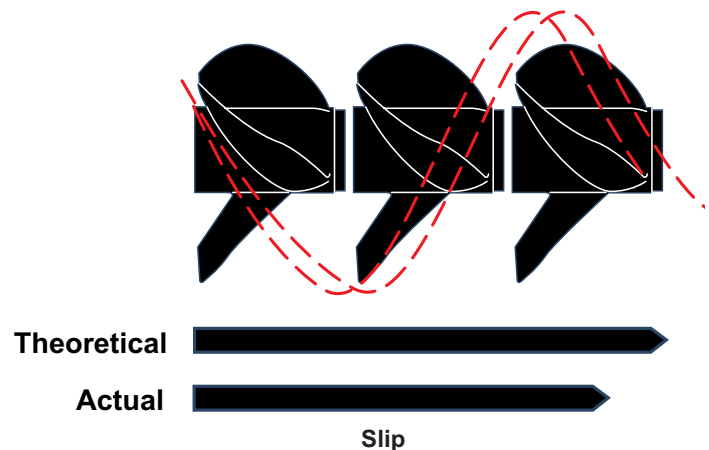

# PROPELLER CHARACTERISTICS

## What is the difference between thru-hub exhaust, over-hub exhaust, and non thru-hub exhaust?

**Thru-hub exhaust** propellers consist of a round barrel to which the blades are attached. The exhaust passes through the barrel and out the back, without making contact with the propeller blades. This provides a good clean water flow to the blades, usually resulting in good acceleration and hole shot.

**Over-hub exhaust** propellers have the blades attached directly to the smaller tube that fits over the propeller shaft, eliminating the larger exhaust tube. These types of propellers are often used for attaining maximum top speeds. (On some boats, the hole shot can often suffer due to the extreme exhaust flooding that occurs around the propeller blades during acceleration.)

**Thru-hub exhaust** and **over-hub exhaust** propellers are used on boats where the exhaust passes out through the rear of the "torpedo" on the lower unit, around the propeller shaft. Most outboards utilize this type of exhaust.

**Over/Thru-hub exhaust propellers** are a combination of thru-hub and over-hub exhaust propellers. This allows some exhaust to escape at lower RPM, providing a controlled amount of exhaust flooding. These types of propellers will allow the propeller to be slightly easier to turn during initial acceleration, allowing for a better hole shot on some engine/boat combinations.

**Non thru-hub exhaust** propellers are used for inboards using shaft driven propellers, sterndrives using through hull exhaust, and on some outboards that don't route the exhaust through the lower unit torpedo.

## Aluminum vs. Stainless Steel?

Most pleasure boats are factory equipped with aluminum propellers. Aluminum propellers are relatively inexpensive, easy to repair, and under normal conditions can last for many years.

Stainless steel is more expensive, but much stronger and durable than aluminum. If you are looking for better performance than can be provided by your aluminum propeller, such as ultimate top speed or better acceleration, a stainless steel propeller may be required.

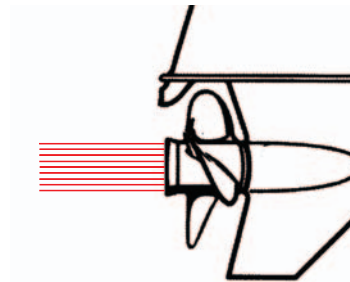

THRU-HUB EXHAUST PROPELLERS

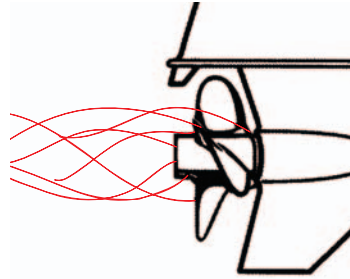

OVER-HUB EXHAUST PROPELLERS

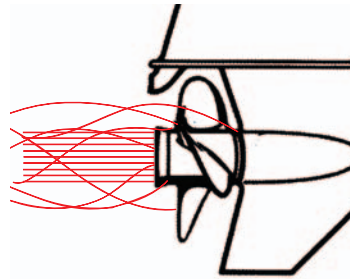

OVER/THRU-HUB EXHAUST PROPELLERS

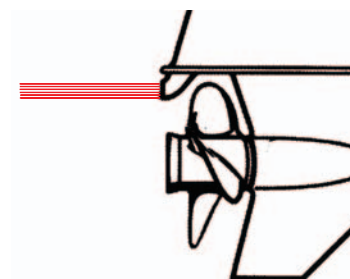

NON THRU-HUB EXHAUST PROPELLERS

# DETERMINING RPM

## Now, determine your wide open throttle (WOT) RPM

For safety and efficient performance, it is critical that your engine operates within the RPM range recommended by the manufacturer. Matching the right prop for the load is the most significant factor of RPM adjustment.

### Effect of Prop Pitch on RPM

A pitch change can increase or decrease the RPM and bring RPM into the recommended range. A 2" **increase** in pitch (for example, from 21" to 23") typically results in a **decrease** of approximately 300-400 RPM.

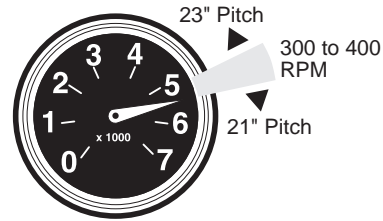

### First, Determine Manufacturer's Recommended RPM

Find the manufacturer's recommended RPM range in the owner's manual or ask your dealer.

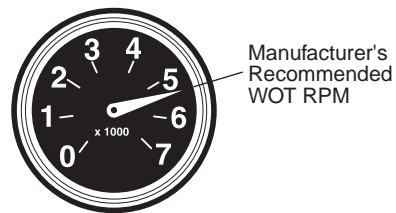

### Test for Maximum RPM

Using the existing propeller or a new propeller, make test runs to determine the maximum RPM and boat speed. Vary the trim angle for optimum performance.



### RPM Higher Than Recommended

If the actual WOT RPM are **above** the recommended RPM range, install the next larger pitch propeller to **decrease** your WOT RPM. Re-test the WOT RPM.

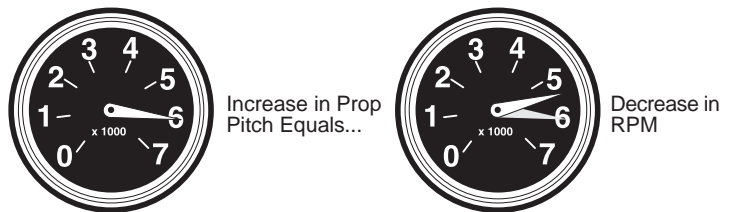

### RPM Lower Than Recommended

If the actual WOT RPM range is below the recommended range, install the next smaller pitch propeller to increase your WOT RPM. Re-test the WOT RPM.

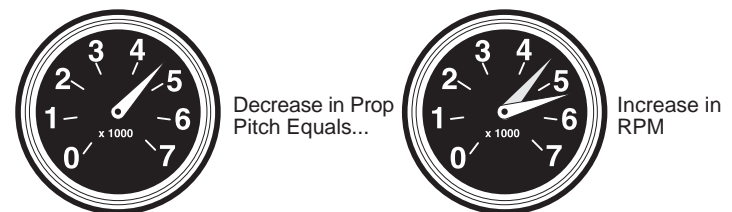

When you combine all these factors, you have the information you need to select the correct propeller for maximum performance, safety, and fuel efficiency.

# The perfect replacement prop!



**High gloss black powder coat finish**, minimizes speed loss from drag, protects aluminum.

**Affordable Replacement Propeller** — manufactured by the leading replacement propeller manufacturer for more than 100 years.

**Cushioned rubber hub**, absorbs impact reducing the potential for lower unit damage.

**Warranty**, Michigan Match propellers are backed by Michigan Wheel's limited lifetime warranty.

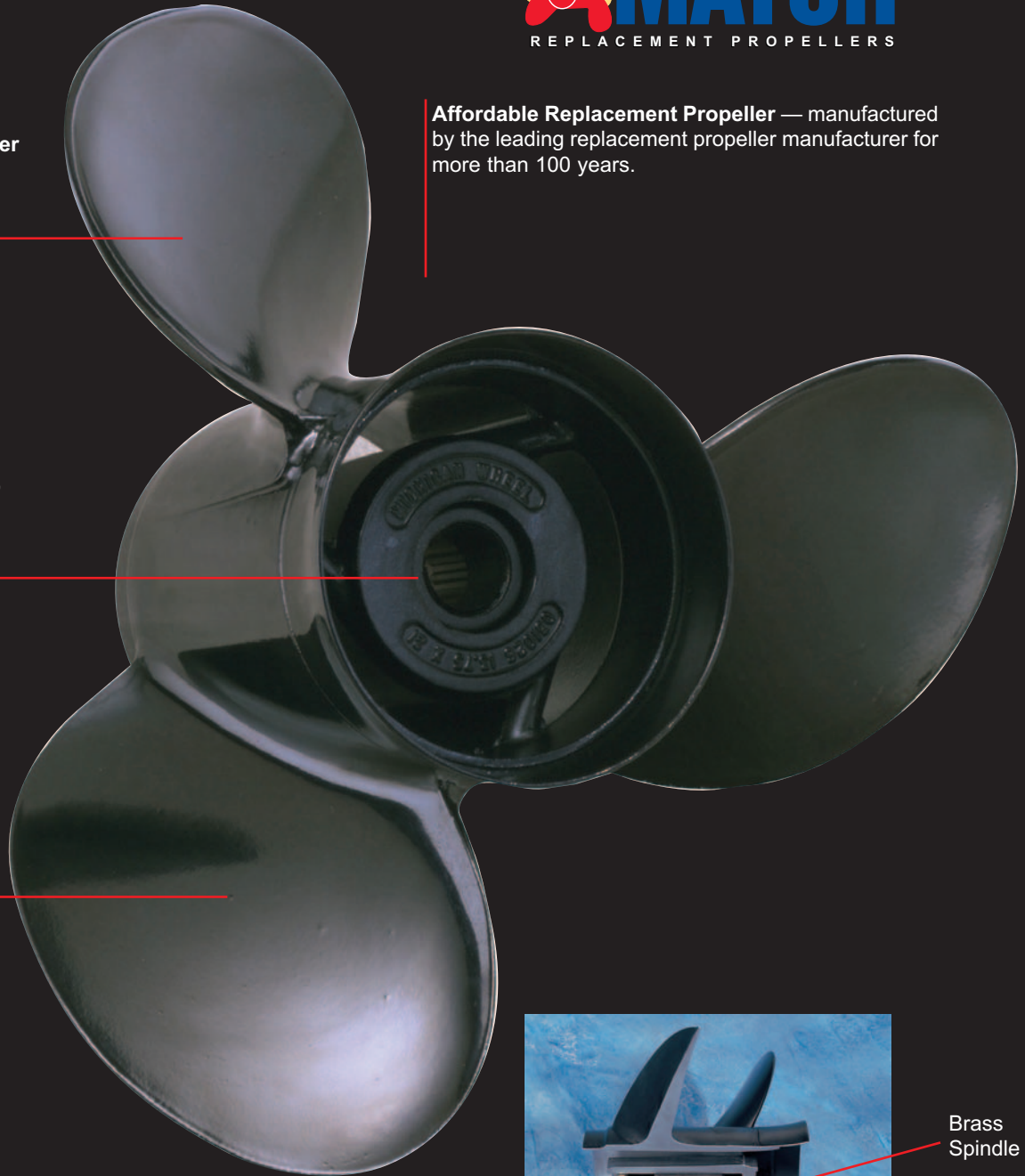

Cutaway of Propeller and Bushing Assembly

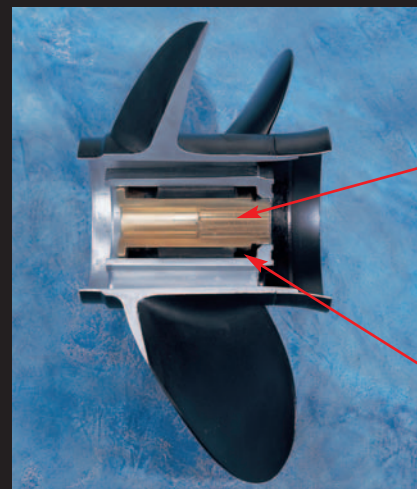

Brass Spindle

Rubber Cushioned Hub

# This is Rapture™.

**RAPTURE**  
Max-Performance Propellers

Cupped trailing blade edge extends past the blade tip to better grab and hold water, dramatically enhancing performance and efficiency.

Sharply thinned leading edges maximize acceleration and reduce speed-robbing drag.

Thickly tapered trailing edge provides durability, and makes the blade easy to repair after heavy impact.

High performance blade geometry features a high rake and progressive pitch design to provide the optimum combination of dead start acceleration, bow lift, and flat out speed.

One piece cast construction of premium 15-5 stainless steel alloy provides superior strength under conditions where welded blades typically fail.

Buffed mirror finish minimizes speed loss from drag, reduces corrosion, and looks great doing it.

Large blade area easily meets high horsepower demands, maximizing thrust and reducing performance-draining phenomena like ventilation or cavitation.

Flared hub design keeps exhaust from causing speed-robbing ventilation blow-out.

Precision balanced blades significantly reduce vibration.

Optimal blade thickness means each blade is carefully engineered thin enough to maximize speed, but thick enough to take punishment.

Vent hole plugs\*\* let you fine tune hole shot and acceleration performance to your unique application.

Precision drilled vent holes\*\* give you maximum hole shot and acceleration from a dead start.

\*\* Only available on V-4 & V-6 Applications.

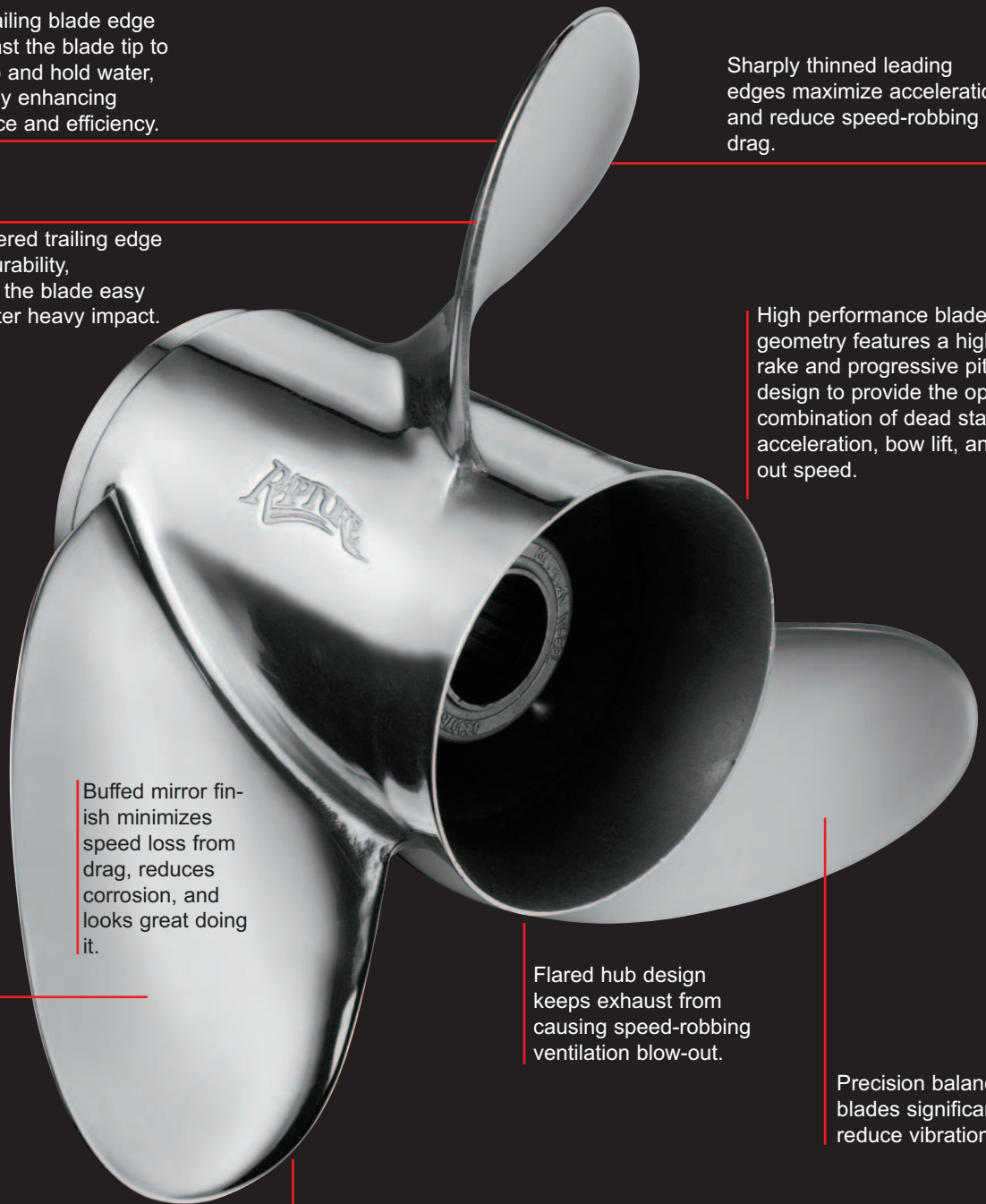

# Advantages That Make A Difference.

**BALLISTIC™**  
STAINLESS STEEL PROPS

**Tapered leading edge** minimizes drag, provides performance characteristics of racing style props while maintaining optimum blade strength and thickness

**Optimized power tip** for peak efficiency; blade tip and cup combine to improve bite and reduce power losses caused by cavitation

**High luster mirror finish** adds appeal and enhances corrosion resistance

Use of **standard OEM hub geometry** simplifies installation, repair and replacement

**One-piece investment cast construction** from 15-5ph stainless steel, the ideal material for strength and corrosion resistance

**Shock-absorbing hub** prevents damage to gears and shaft caused by shifting and prop impact

**Highly cambered blade sections** provide for higher speed and better bow lift

**Blades are hand balanced** during finishing to assure consistency and minimize vibration



13-inch models feature solid-cast flared hub to prevent performance loss from ventilation



14-inch models with high pitch (21", 23" and 25") have a vented hub design that allows the engine to come up to speed and get on plane quickly



# Vortex™ propellers and XHS™ Exchangeable Hub Systems...performance and versatility.



PERFORMANCE PROPELLERS

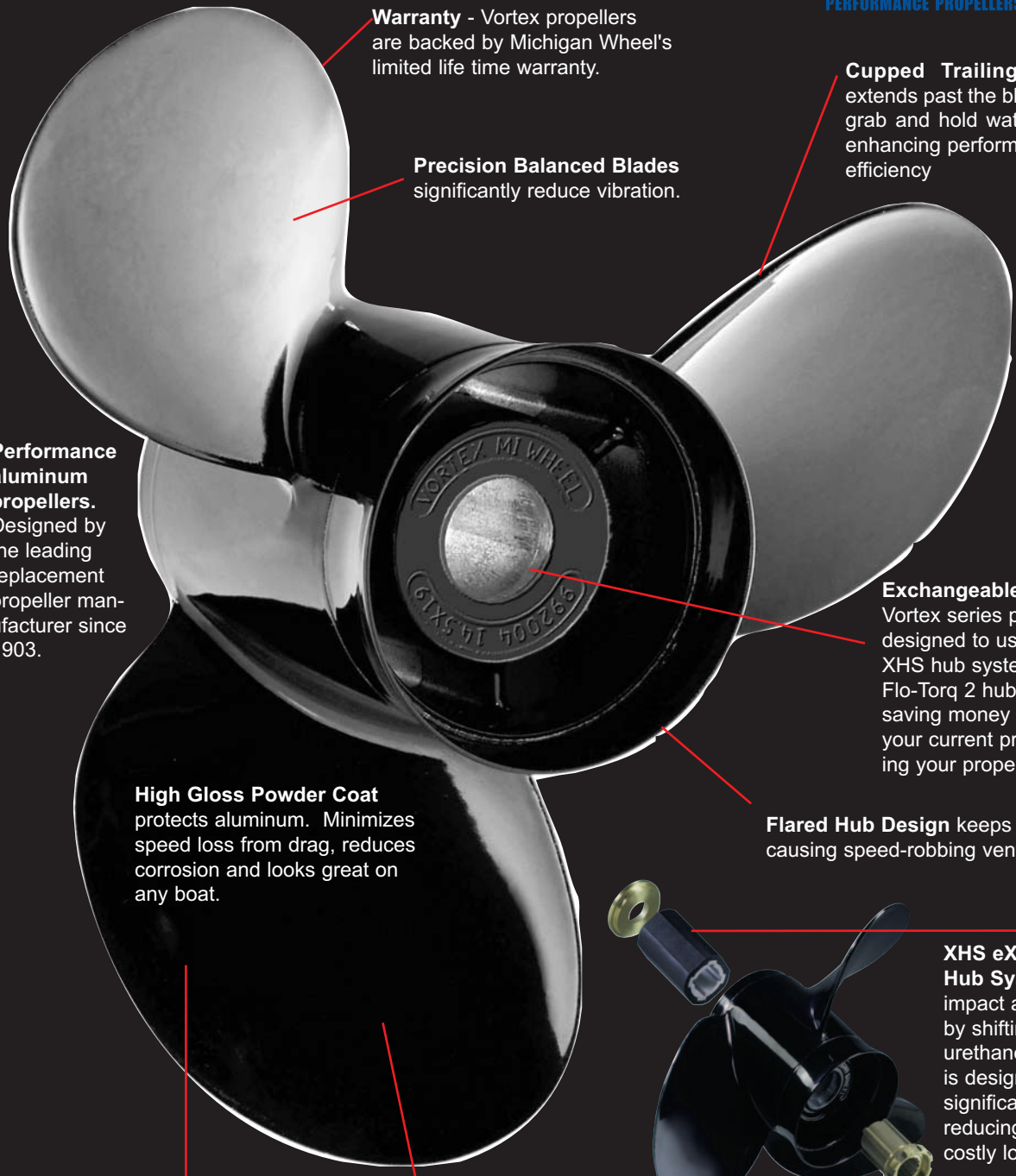

**Warranty** - Vortex propellers are backed by Michigan Wheel's limited life time warranty.

**Precision Balanced Blades** significantly reduce vibration.

**Cupped Trailing Blade Edge** extends past the blade tip to better grab and hold water, dramatically enhancing performance and efficiency

**Performance aluminum propellers.** Designed by the leading replacement propeller manufacturer since 1903.

**High Gloss Powder Coat** protects aluminum. Minimizes speed loss from drag, reduces corrosion and looks great on any boat.

**Exchangeable Hub System.** Vortex series propellers are designed to use Michigan Wheel's XHS hub system or Mercury's Flo-Torq 2 hub system. Potentially saving money when replacing your current propeller or upgrading your propeller in the future.

**Flared Hub Design** keeps exhaust from causing speed-robbing ventilation blow-out.



**XHS eXchangeable Hub System** absorbs impact and stress caused by shifting gears. The urethane cushioned hub is designed to spin under significant impact, reducing the potential for costly lower unit damage.

**Optimal Blade Thickness.** Each blade is carefully engineered thin enough to maximize performance but thick enough to provide long lasting durability.

**High performance blade geometry** higher degree rake and progressive pitch design results in a better combination of top end speed dead start acceleration.

# NEW Rapture with exchangeable hub system!

**RAPTURE™ XHS™**

Highly polished stainless steel performance propeller! A proven combination of performance and durability that will wake up your sterndrive or outboard.

**XHS eXchangeable Hub System** absorbs impact and stress caused by shifting gears. The urethane cushioned hub is designed to spin under significant impact, reducing the potential for costly lower unit damage.

Buffed mirror finish minimizes speed loss from drag, reduces corrosion, and looks great doing it.

High performance blade geometry features a high rake and progressive pitch design to provide the optimum combination of dead start acceleration, bow lift, and flat out speed.

## **Exchangeable Hub System.**

Rapture<sup>XHS™</sup> series propellers are designed to use Michigan Wheel's XHS hub system or Mercury's Flo-Torq 2 hub system. Potentially saving money when replacing your current propeller or upgrading your propeller in the future.

**Note:** Rapture<sup>XHS™</sup> utilizes the Xchangeable Hub System in all V-4 and V-6 applications.



AMBUSH-2002

# Smooth power times four.

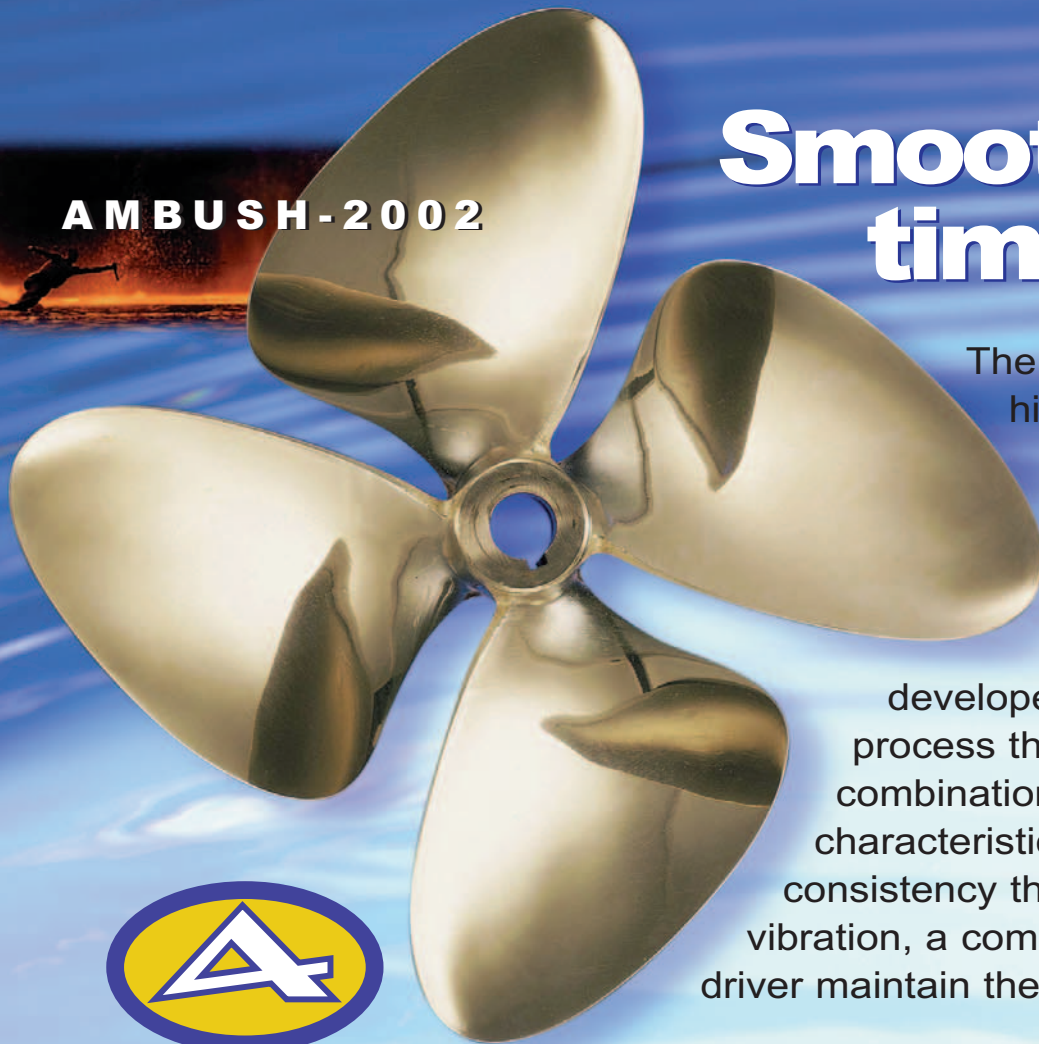

The **Ambush4™** is a new, highly polished precision balanced 4 blade NiBrAl propeller designed specifically for the ski and wakeboard enthusiast. We have developed a manufacturing process that offers you the greatest combination of performance characteristics while offering blade consistency that significantly minimizes vibration, a combination that will help your driver maintain the steady speed you need.



**Ambush4™**

**The polish. The pull. The prop to remember.**



Part Number	Dia. x Pitch	Rotation	Bore	
635101	13 x 13	LH	1"	
635103	13 x 13	LH	1-1/8"	
635300	13 x 16	RH	1"	
635302	13 x 16	RH	1-1/8"	
635341	13-1/2 x 17-1/2	LH	1"	(NEW)
635343	13-1/2 x 17-1/2	LH	1-1/8"	(NEW)
635400	14 x 18	RH	1"	
635401	14 x 18	LH	1"	
635402	14 x 18	RH	1-1/8"	
635403	14 x 18	LH	1-1/8"	
635404	14 x 18	RH	1-1/4"	
635405	14 x 18	LH	1-1/4"	
635441	14 x 20	LH	1"	(NEW)
635443	14 x 20	LH	1-1/8"	

**Michigan  
Wheel  
Corporation**

Outboard/Sterndrive Division  
2685 Northridge Ave. N.W.  
Suite G  
Grand Rapids, MI 49544  
Phone: (616) 452-6941  
Fax: (616) 246-1440

Inboard Division  
1501 Buchanan Ave. S.W.  
Grand Rapids, MI 49507  
Phone: (616) 452-6941  
Fax: (616) 247-0227

E-mail: [info@miwheel.com](mailto:info@miwheel.com)  
Web site: [www.miwheel.com](http://www.miwheel.com)

# Application Guide



**Ambush<sup>TM</sup>4**

Manufacturer	Application	Transmission	4-Blade	Ambush P/N
<b>Brendella</b>	Prior to 1992	1:1	13 x 13 LH 1"	635101
	After 1992	1:1	13 x 13 LH 1-1/8"	635103
	N/A	1.23:1	14 x 16 LH 1"	*
<b>Centurian</b>	Eclipse / Elite	1:1	13 x 13 LH 1-1/8"	635103
<b>Correct Craft</b>	Ski Nautique	1:1	13 x 13 RH 1"	*
	Ski Nautique	1.23:1	13 x 16 RH 1"	635300
	V-Drives	1.46:1	14 x 18 RH 1-1/8"	635402
	Barefoot w/454	1:1	14 x 14 RH 1"	*
<b>Malibu</b>	Prior to 1992	1:1	13 x 13 LH 1"	635101
	After 1992	1:1	13 x 13 LH 1-1/8"	635103
	Boats w/320 HP	1:1	13 x 14 LH 1-1/8"	*
	V-Drives	1.46:1	14 x 18 LH 1-1/8"	635403
	8.1 Litre	1.5	14 x 20 LH 1-1/8"	635443
<b>Mastercraft</b>	N/A	1:1	13 x 13 LH 1"	635101
	N/A	1.5:1	14 x 18 LH 1-1/8"	635403
	Boats w/454	1:1	13 x 14 LH 1"	*
	1988 TBI Eng.	1:1	13 x 13 LH 1"	635101
	1998 TBI Eng.	1.5:1	14 x 20 LH 1-1/8"	635443
<b>M.B. Sports</b>	N/A	1:1	13 x 13 LH 1-1/8"	635103
<b>Moomba</b>	Kanga, Mobius Pro	1:1	13 x 13 LH 1"	635101
	Outback	1:1	13 x 13 LH 1"	635101
	Kamberra, Mobius V	1.5	14 x 18 LH 1-1/8"	635403
<b>Sanger</b>	Prior to 1992	1:1	13 x 13 LH 1"	635101
	After 1992	1:1	13 x 13 LH 1-1/8"	635103
<b>Supra</b>	N/A	1:1	13 x 13 LH 1"	635101
	N/A	1.23:1	13 x 16 RH 1"	635300
	Boats w/454	1:1	N/A	*
<b>Tige</b>	201 / 2100 Riders	1:1	13 x 13 LH 1-1/8"	635103
	2100 V LTD, 21 V Riders	1.5	14 x 18 LH 1-1/8"	635403
	2300 V LTD	1.5	14 x 18 LH 1-1/8"	635403

\*Call for availability. Ski Nautique is a registered trademark of Correct Craft.

Eat My Wake

# DYNA-JET CUPPED

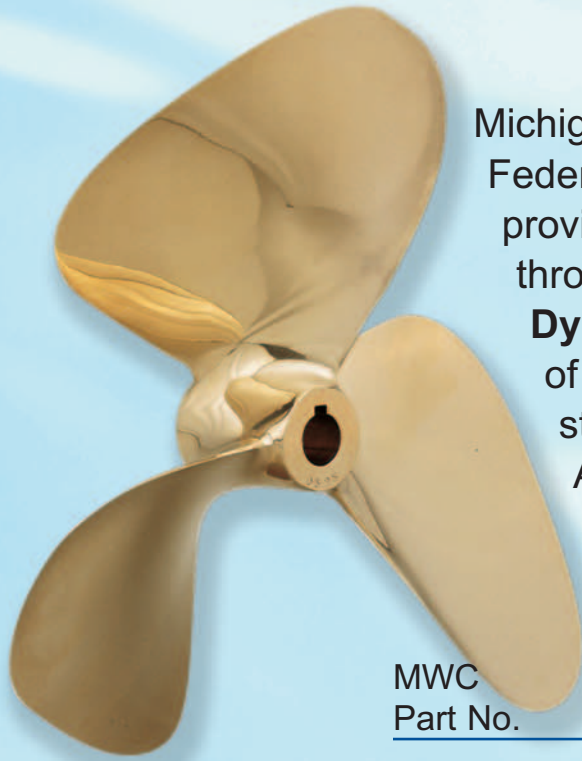

Michigan Wheel Corporation's Federal Series ski boat propellers provide consistent response to your throttle commands. The **3-blade Dyna-Jet Cupped** Propellers are made of a NiBrAl alloy which provides extra strength, less flex, and greater durability. All are cupped to minimize the performance draining effects of cavitation.

MWC Part No.	Dia. x Pitch	Rot.	Bore
310649	13 x 12	LH	1"
310625	13 x 12-1/2	LH	1-1/8"
310660	13 x 13	RH	1"
310661	13 x 13	LH	1"
310659	13 x 13	LH	1-1/8"
310705	13 x 13-1/2	LH	1-1/8"
310724	13 x 14	RH	1"
310725	13 x 14	LH	1"
310727	13 x 14	LH	1-1/8"
310763	13 x 15	LH	1"
310765	13 x 15	LH	1-1/8"
310801	13 x 15-1/2	LH	1-1/8"
310836	13 x 17	RH	1"
311244	14 x 15	RH	1"
311284	14 x 16	RH	1"
311360	14 x 18	RH	1-1/8"
311361	14 x 18	LH	1-1/8"



•All styles are Dyna Jet Cup

•Dynamic Balancing

# HOW TO USE THIS BOOK

- If original equipment part number (OEM) is known and a size or style change is not desired, then refer to Part Number Cross Reference on pages 17-49 to locate the equivalent Michigan propeller.
- If an original part number is not known, the part number can not be found in the Part Number reference, or a propeller size or style change is desired, use the following procedure for selecting a propeller.
  - 1 Locate the brand of outboard or sterndrive using the table of contents.
  - 2 Locate the **Horsepower/Model** and **Year** that corresponds with the engine brand.
  - 3 Locate the range of your boats length, and the boat use that best describes your vessel and usage.
  - 4 Select the propeller **Diameter/Pitch** that best meets your vessel and usage.  
The propeller sizes to the right of the boat length/description are suggestions for that application. Often 2 or more pitch sizes are listed for a given boat length. The higher the pitch, the more top speed potential, but less power for acceleration. The lower the pitch, the less top speed potential but more power for acceleration.
  - 5 Order the propeller using the **Michigan Part Number**. (If aluminum is desired, read across to the correct column for the part number. If stainless is desired, read across to the correct column for the part number.)
  - 6 If **Vortex<sup>XHS</sup>** or **Rapture<sup>XHS</sup>** propellers are selected, the **XHS™ Hub Kit** indicated must be ordered.  
Unless otherwise noted: The XHS™ hub kit is sold separately from the propeller. See page 104 for XHS™ hub kit and miscellaneous hardware information. Vortex<sup>XHS</sup> and Rapture<sup>XHS</sup> propellers fit existing Mercury® Flo-Torq II™ hubs. Check existing hub for wear or damaged and replace if necessary with Michigan Wheel XHS™ hub.

**Note:** This is a "general" application guideline for determining the appropriate propeller size for your vessel. Performance characteristics may vary due to the many kinds of boats, hull styles, loads and style of boating.

Example Application: 18' Runabout used mainly for skiing and cruising with the family.  
1988, 120 HP Johnson Outboard. Customer wants a cupped, aluminum propeller.

## 1 EVINRUDE®, JOHNSON® OUTBOARDS

### 85-140 HORSEPOWER • V-4 GEARCASE Thru Hub Exhaust & 13 Tooth Spline

		VORTEX <sup>XHS</sup> PERFORMANCE PROPPELLERS					RAPTURE <sup>XHS</sup>				
Boat Length/Description	Dia., Rot., Pitch	Bld#	Mat'l	OEM	Part No.	Dia. x Pitch	Bld#	RH	LH		
85 HP	1967-80, 1991-95	110 HP	1986-89	125 HP	1971-72						
88 HP	1986-1996	112 HP	1994	135 HP	1973-76						
90 HP	1981 & Newer	115 HP	1973 & Newer	140 HP	1977-94						
100 HP	1979-80, 1988-93	120 HP	1986-94								
Boat Length/Description	Dia., Rot., Pitch	Bld#	Mat'l	OEM	Part No.	Dia. x Pitch	Bld#	RH	LH		
19-22' - RB, SK	13-3/4 R 15	3	AL	391198	992103	13-1/4 x 15	3	993103			
18-21' - RB, SK	13-1/4 R 17	3	AL	391199	992104	13-1/4 x 17	3	993104			
17-20' - RB, SK	13 R 19	3	AL	390896	992105	13-1/4 x 19	3	993105			
15-18' - RB, SK	12-3/4 R 21	3	AL	389788	992106	13-1/4 x 21	3	993106			
Boat Length/Description	Dia., Rot., Pitch	Bld#	Mat'l	OEM	Part No.	Dia. x Pitch	Bld#	RH	LH		
CR, HB	14 R 10	4	AL		012074						
CR, HB	14 R 10	4	AL		012075						
CR, HB	14 R 11	3	AL	38276	012047						
CR, HB	14 R 11	3	AL		*011038						
CR, HB	14 R 12	4	AL		012075						
CR, HB	14 R 12	4	AL		*011037						
CR, HB	14 R 13	AL		391668	*011001						
20-24' - AL, SK	13-3/4 R 15	3	AL	391198	*011002	13-5/8 x 15	3	335030			
20-24' - AL, SK	13-3/4 R 15	3	SS	389949	013028						
19-22' - AL, SK	13-1/4 R 17	3	AL	391199	*011003	13-1/2 x 17	3	335031			
19-22' - AL, SK	13-3/8 R 17	3	SS	389948	013030						
19-22' - AL, SK	14 R 17	3	AL	176214	*011024						
17-19' - AL, SK	13 R 19	3	AL	390896	*011004	13-3/8 x 19	3	335032			
17-19' - AL, SK	13 R 19	3	SS	389510	013033						
17-19' - AL, SK	14 R 19	3	AL	176215	*011025						
15-18' - AL, SK	12-3/4 R 21	3	AL	389788	*011005	13-1/8 x 21	3	335033			
15-18' - AL, SK	12-3/4 R 21	3	SS	389512	013034						
15-18' - AL, SK	14 R 21	3	AL	176216	*011026						
High Performance						13-1/2 x 22	3	335034			
High Performance						13-1/2 x 24	3	335035			

Use XHS™ Hub Kit 106  
Do NOT use Gearcase Adapter Ring supplied with propeller.

Rubber Hub Bushing

Key to abbreviations: AL: All Loads; CR: Cruisers; HB: Houseboat; HL: Heavy Loads; LL: Light Loads; RB: Runabouts; SB: Sailboat; SK: Skiboat; WB: Workboat; WD: Weedless

\* Indicates a cupped propeller. \* If currently using uncupped propeller, use cupped propeller having 2" less pitch. Boats with power trim use same pitch.

# PROPELLER CROSS REFERENCE

---

---

**MWC ALPHA-NUMERIC CROSS REFERENCE**  
(PAGE B2)

**OEM CROSS REFERENCE**  
(PAGES B3 - B35)

**XHS™ HUB SYSTEM TO MERCURY FLO-TORQ™ II  
HUB SYSTEM CROSS REFERENCE**  
(PAGE B35)

**MICHIGAN MATCH TO XHS™ CROSS REFERENCE**  
(PAGE B36)







**RAPTURE TO XHS CROSS REFERENCE**  
(PAGES B37-B38)

# MICHIGAN WHEEL ALPHA-NUMERIC CROSS REFERENCE







Alpha Numeric	Numeric	Page#	Alpha Numeric	Numeric	Page#	Alpha Numeric	Numeric	Page#
AM431	012067	2	PJ 95	012054	3	PR126	012094	43
AMC308	072014	10, 11	PJ 96	012055	3	PR151	032089	37
AMC310	072131	11	PJ 97	012056	3	PR153	032090	37
AMC314	072133	11	PJ 98	012057	3	PR155	032091	37
AMC316	072134	11	PJ199-C	011015	8, 9, 39, 40	PR155-C	031001	Obsolete
AMC394	072132	11	PJ200-C	011016	8, 9, 39-42, 44, 45	PR157	032092	37
AMC422	012068	2	PJ201-C	011006	8, 9, 39-42, 44, 45	PR157-C	031002	Obsolete
AMC490	152002	Obsolete	PJ202-C	011007	8, 9, 39-42, 44, 45	PR159	032093	37
AMC580-S	032077	18	PJ203-C	011008	8, 9, 39-42, 44, 45	PR159-C	031003	Obsolete
DQ320	012074	6, 7	PJ204-C	011009	8, 9, 39-42, 44, 45	PR161	032094	37
DQ328	012075	6, 7	PJ205-C	011010	8, 9, 39-42, 44, 45	PR161-C	031004	Obsolete
EWC19	012076	3	PJ300	012060	2	PR276	072054	12
G 20	072017	10	PM 8	032014	39, 40	PR278	072055	12
G 30	152014	10	PM 19	032019	17	PR339	032099	18
NP 74	302001	6, 43	PM 20	032020	17	SMC 18	012101	2
PC 12	072024	10	PM 21	032021	17	SMC 39	012102	3, 18, 28
PC 20	072026	10	PM 22-C	031047	11, 17	SMC292	082022	46
PC 28	072122	10	PM 23-C	031048	11, 17	SMC293	082021	46
PC 32	072121	10	PM 24-C	031049	11, 17	SMC295	082023	46
PC112	072123	10	PM 39	022001	18, 29	SMC348	082033	46
PJ 3	012001	2	PM 40	022002	18, 29	SMC349	082034	46
PJ 7	012004	2	PM 42	022003	18, 29	SMC374-C	031035	Obsolete
PJ 8	012005	2	PM211-C	031021	21, 31, 34, 35	SMC376-C	031036	37
PJ 9	012006	2	PM213-C	031022	21, 31, 34, 35	SMC378-C	031037	37
PJ 10	012007	2	PM215-C	031023	21, 31, 34, 35	SMC380-C	031038	37
PJ 11	012008	2, 28	PM217-C	031024	21, 31, 34, 35	SMC382-C	031039	37
PJ 15	012010	18	PM219-C	031025	21, 31, 34, 35	SMC504-C	031034	37
PJ 16	012011	3	PM221-C	031026	21, 31, 34, 35	SMC921	082045	46
PJ 18	012013	3	PM223-C	031027	21, 31, 34, 35	SMC980	082057	46
PJ 19	012109	3	PM311-C	031054	13, 15, 16, 20	SPC180	072107	12
PJ 21	012014	3	PM313-C	031055	13, 15, 16, 20	SPC182	072108	12
PJ 22	012015	3	PM315-C	031041	13, 15, 16, 20	SPC184	072109	12
PJ 24	012016	3	PM317-C	031042	13, 15, 16, 20	SSC315-C	073002	12
PJ 29	012021	3	PM319-C	031043	13, 15, 16, 20	SSC317-C	073003	12
PJ 30	012022	4	PM321-C	031044	13, 15, 16, 20	SSC319-C	073004	12
PJ 31	012023	4	PM323-C	031045	13, 15, 16, 20	SSM212-C	033001	11, 19
PJ 32	012024	4	PM513	032039	15, 19, 26, 29	SSM245-C	033002	21, 31, 34, 35
PJ 35	012025	4	PM515	032040	15, 19, 26, 29	SSM247-C	033003	21, 31, 34, 35
PJ 40	012026	4	PM518	032041	15, 19, 26, 29	SSM249-C	033004	21, 31, 34, 35
PJ 41	012027	4, 43	PM521	032042	15, 19, 26, 29	SSM251-C	033005	21, 31, 34, 35
PJ 42	012028	4, 30	PM524	032043	15, 19, 26, 29	SSM253-C	033006	21, 31, 34, 35
PJ 45	012030	3	PM527	032044	15, 19, 26, 29	SSM350-C	033007	37
PJ 47	012031	2	PM530	032045	15, 19, 26, 29	SSM354-C	033008	37
PJ 49	012032	2	PM600-C	031015	11, 19	SSM358-C	033009	37
PJ 50	012033	Obsolete	PM612-C	031016	11, 19	SSM615-C	033016	13, 15, 16, 20
PJ 58	012036	5	PM613-C	031017	11, 19	SSM617-C	033017	13, 15, 16, 20
PJ 59	012037	5	PM614-C	031018	11, 19	SSM619-C	033018	13, 15, 16, 20
PJ 60	012038	5	PM615-C	031019	11, 19	SSM621-C	033019	13, 15, 16, 20
PJ 61	012039	5	PM617-C	031020	11, 19	SSO315-C	013010	5
PJ 62	012040	5	PR 33	032084	18, 37	SSV171-C	083001	46
PJ 74	012042	6, 43	PR 35	032085	18, 37	SSV172-C	083002	46
PJ 75	012043	6, 43	PR 37	032086	18, 37	SSV191-C	083003	46
PJ 76	012044	6, 43	PR 39	032087	18, 37	SSV192-C	083004	46
PJ 77	012045	6, 43	PR 78	072032	12	SSV211-C	083005	46
PJ 83-C	011005	6, 7, 38, 43	PR 80	072033	12	SSV212-C	083006	46
PJ 87	012047	6, 7, 38, 43	PR 82	072034	12	SSY615-C	103025	32, 48
PJ 88-C	011001	6, 7, 38, 43	PR115	012089	7, 43	SSY617-C	103026	30
PJ 89-C	011002	6, 7, 38, 43	PR118	012090	7, 43	SSY619-C	103027	30
PJ 90-C	011003	6, 7, 38, 43	PR120	012091	43	SSY717-C	103018	32, 48
PJ 91-C	011004	6, 7, 38, 43	PR122	012092	43	SSY719-C	103020	32, 48
PJ 94	012053	3	PR124	012093	43	SSY721-C	103022	32, 48









# MICHIGAN WHEEL OEM CROSS REFERENCE

Original Equipment Manufacturer Part & Trade Mark	Standard Hub Propellers				XHS Hub Propellers			Catalog Page #
								
<b>EVINRUDE, JOHNSON, OMC</b>								
174811 . . . . . VIPER™(LH)	. . . . .	.013069	.345063	. . . . .	. . . . .	.993014	.See Note 2 .	8, 9, 39, 40, 41, 42, 44, 45
174812 . . . . . VIPER™(LH)	. . . . .	.013071	.345064	. . . . .	. . . . .	.993015	.See Note 2 .	8, 9, 39, 40, 41, 42, 44, 45
174813 . . . . . VIPER™(LH)	. . . . .	.013073	.345065	. . . . .	. . . . .	.993016	.See Note 2 .	8, 9, 39, 40, 41, 42, 44, 45
174814 . . . . . VIPER™	. . . . .	.013068	.345033	. . . . .	. . . . .	.993004	.See Note 2 .	8, 9, 39, 40, 41, 42, 44, 45
174815 . . . . . VIPER™	. . . . .	.013070	.345034	. . . . .	. . . . .	.993005	.See Note 2 .	8, 9, 39, 40, 41, 42, 44, 45
174816 . . . . . VIPER™	. . . . .	.013072	.345035	. . . . .	. . . . .	.993006	.See Note 2 .	8, 9, 39, 40, 41, 42, 44, 45
174889 . . . . . VIPER™	. . . . .	.013066	.345032	. . . . .	. . . . .	.993003	.See Note 2 .	8, 9, 39, 40, 41, 42, 44, 45
174890 . . . . . VIPER™(LH)	. . . . .	.013067	.345062	. . . . .	. . . . .	.993013	.See Note 2 .	8, 9, 39-42, 44, 45
174926 . . . . . SST II®	.013052	.013064	.345031	. . . . .	. . . . .	.993002	.See Note 2 .	8, 9, 39, 40, 41, 42, 44, 45
174927 . . . . . SST II® (LH)	.013051	.013065	. . . . .	. . . . .	. . . . .	.993012	.See Note 2 .	8, 9, 39, 40, 41, 42, 44, 45
174950 . . . . .	.012111	. . . . .	. . . . .	. . . . .	. . . . .	. . . . .	. . . . .	3
175190 . . . . .	.012055	. . . . .	. . . . .	. . . . .	.992503	. . . . .	.118 . . . .	3
175191 . . . . .	.012056	. . . . .	.305029	. . . . .	.992505	. . . . .	.118 . . . .	3
175738 . . . . . Renegade™ Bass	. . . . .	. . . . .	. . . . .	.435036	. . . . .	. . . . .	. . . . .	8, 9
175739 . . . . . Renegade™ Bass	. . . . .	. . . . .	. . . . .	.435037	. . . . .	. . . . .	. . . . .	8, 9
176058 . . . . . Renegade™ Bass	. . . . .	. . . . .	. . . . .	.435035	. . . . .	. . . . .	. . . . .	8, 9
176196 . . . . . Renegade™ Bass	. . . . .	.013079	. . . . .	. . . . .	. . . . .	.993106	. . .106 . . . .	55,57
176214 . . . . .	.011024	.013077	.335031	. . . . .	.992104	.993104	. . .106 . . . .	6, 7, 38, 43
176215 . . . . .	.011025	.013078	.335032	. . . . .	.992105	.993105	. . .106 . . . .	6, 7, 38, 43
176216 . . . . .	.011026	.013079	.335033	. . . . .	.992106	.993106	. . .106 . . . .	6, 7, 38, 43
176421 . . . . .	.011027	.013082	.325030	. . . . .	. . . . .	. . . . .	. . . . .	5
176422 . . . . .	.011028	.013083	.325031	. . . . .	. . . . .	. . . . .	. . . . .	5
176423 . . . . .	.011029	.013084	. . . . .	. . . . .	. . . . .	. . . . .	. . . . .	5
176572 . . . . . SST II®	. . . . .	.013077	.335031	. . . . .	. . . . .	.993104	. . .106 . . . .	6, 7, 38, 43
176573 . . . . . SST II®	. . . . .	.013078	.335032	. . . . .	. . . . .	.993105	. . .106 . . . .	6, 7, 38, 43
176574 . . . . . SST II®	. . . . .	.013079	.335033	. . . . .	. . . . .	.993106	. . .106 . . . .	6, 7, 38, 43
176575 . . Renegade™ O.S.(RH)	. . . . .	.013066	.345032	. . . . .	. . . . .	.993003	.See Note 2 .	8, 9, 39, 40, 41, 42, 44, 45
176576 . . Renegade™ O.S.(RH)	. . . . .	.013068	.345033	. . . . .	. . . . .	.993004	.See Note 2 .	8, 9, 39, 40, 41, 42, 44, 45
176577 . . Renegade™ O.S.(RH)	. . . . .	.013070	.345034	. . . . .	. . . . .	.993005	.See Note 2 .	8, 9, 39, 40, 41, 42, 44, 45
176578 . . . . . Renegade O.S.(LH)	. . . . .	.013067	.345062	. . . . .	. . . . .	.993013	.See Note 2 .	8, 9, 39, 40, 41, 42, 44, 45
176579 . . . . . Renegade O.S.(LH)	. . . . .	.013069	.345063	. . . . .	. . . . .	.993014	.See Note 2 .	8, 9, 39, 40, 41, 42, 44, 45
176580 . . . . . Renegade O.S.(LH)	. . . . .	.013071	.345064	. . . . .	. . . . .	.993015	.See Note 2 .	8, 9, 39, 40, 41, 42, 44, 45
176615 . . . . . Swept-Blade™	. . . . .	.013066	.345032	. . . . .	. . . . .	.993003	.See Note 2 .	8, 9, 39, 40, 41, 42, 44, 45
176616 . . . . . Swept-Blade™(LH)	. . . . .	.013067	.345062	. . . . .	. . . . .	.993013	.See Note 2 .	8, 9, 39, 40, 41, 42, 44, 45
176617 . . . . . Swept-Blade™	. . . . .	.013068	.345033	. . . . .	. . . . .	.993004	.See Note 2 .	8, 9, 39, 40, 41, 42, 44, 45
176618 . . . . . Swept-Blade™(LH)	. . . . .	.013069	.345063	. . . . .	. . . . .	.993014	.See Note 2 .	8, 9, 39, 40, 41, 42, 44, 45
176619 . . . . . Swept-Blade™	. . . . .	.013070	.345034	. . . . .	. . . . .	.993005	.See Note 2 .	8, 9, 39, 40, 41, 42, 44, 45
176620 . . . . . Swept-Blade™(LH)	. . . . .	.013071	.345064	. . . . .	. . . . .	.993015	.See Note 2 .	8, 9, 39, 40, 41, 42, 44, 45
176623 . . . . . VIPER™	. . . . .	.013077	.335031	. . . . .	. . . . .	.993104	. . .106 . . . .	6, 7, 38, 43
176624 . . . . . VIPER™	. . . . .	.013078	.335032	. . . . .	. . . . .	.993105	. . .106 . . . .	6, 7, 38, 43
176625 . . . . . VIPER™	. . . . .	.013079	.335033	. . . . .	. . . . .	.993106	. . .106 . . . .	6, 7, 38, 43
176626 . . . . . Swept-Blade™	. . . . .	.013066	.345032	. . . . .	. . . . .	.993003	.See Note 2 .	8, 9, 39, 40, 41, 42, 44, 45
176627 . . . . . Swept-Blade™	. . . . .	.013068	.345033	. . . . .	. . . . .	.993004	.See Note 2 .	8, 9, 39, 40, 41, 42, 44, 45
176628 . . . . . Swept-Blade™	. . . . .	.013070	.345034	. . . . .	. . . . .	.993005	.See Note 2 .	8, 9, 39, 40, 41, 42, 44, 45
176629 . . . . . Swept-Blade™(LH)	. . . . .	.013067	.345062	. . . . .	. . . . .	.993013	.See Note 2 .	8, 9, 39, 40, 41, 42, 44, 45
176630 . . . . . Swept-Blade™(LH)	. . . . .	.013069	.345063	. . . . .	. . . . .	.993014	.See Note 2 .	8, 9, 39, 40, 41, 42, 44, 45
176902 . . . . . Swept-Blade™(LH)	. . . . .	.013071	.345064	. . . . .	. . . . .	.993015	.See Note 2 .	8, 9, 39, 40, 41, 42, 44, 45
176969 . . . . . SST®	. . . . .	.013068	. . . . .	. . . . .	. . . . .	.993004	.See Note 2 .	8, 9, 39, 40, 41, 42, 44, 45
176970 . . . . . SST®	. . . . .	.013068	. . . . .	. . . . .	. . . . .	.993004	.See Note 2 .	8, 9, 39, 40, 41, 42, 44, 45
176971 . . . . . SST®	. . . . .	.013070	. . . . .	. . . . .	. . . . .	.993005	.See Note 2 .	8, 9, 39, 40, 41, 42, 44, 45
176973 . . . . . SST® (LH)	. . . . .	.013067	. . . . .	. . . . .	. . . . .	.993013	.See Note 2 .	8, 9, 39, 40, 41, 42, 44, 45
176999 . . . . . Renegade O.S.(RH)	. . . . .	.013072	. . . . .	. . . . .	. . . . .	.993006	.See Note 2 .	8, 9, 39, 40, 41, 42, 44, 45
177000 . . . . . Renegade O.S.(LH)	. . . . .	.013073	. . . . .	. . . . .	. . . . .	.993016	.See Note 2 .	8, 9, 39, 40, 41, 42, 44, 45
177034 . . . . . SST®	. . . . .	.013064	. . . . .	. . . . .	. . . . .	.993002	.See Note 2 .	8, 9, 39, 40, 41, 42, 44, 45
177035 . . . . . SST®	. . . . .	.013066	. . . . .	. . . . .	. . . . .	.993003	.See Note 2 .	8, 9, 39, 40, 41, 42, 44, 45
177042 . . . . . VIPER™	. . . . .	.013076	. . . . .	. . . . .	. . . . .	.993103	. . .106 . . . .	8, 9, 39, 40, 41, 42, 44, 45
177131 . . . . .	. . . . .	. . . . .	. . . . .	. . . . .	.992104	.993104	. . . .110 . . . .	5
177134 . . . . .	. . . . .	. . . . .	. . . . .	. . . . .	.992003	.993003	.See Note 2 .	8, 9







# MICHIGAN WHEEL OEM CROSS REFERENCE

Original Equipment Manufacturer Part & Trade Mark	Standard Hub Propellers				XHS Hub Propellers			Catalog Page #
								
<b>EVINRUDE, JOHNSON, OMC (continued)</b>								
177135					.992004	.993004	.See Note 2	8, 9
177136					.992005	.993005	.See Note 2	8, 9
177137					.992006	.993006	.See Note 2	8, 9
178811	VIPER™(LH)	.013069				.993014	.See Note 2	33,55,57
178814	VIPER™	.013068				.993004	.See Note 2	33,55,57
203120	.012001							2
203682	.012001							2
203919	.012001							2
204347	.012001							2
277212	.012076							3
277440	.012060							2
277443	.012076							3
277580	.012024							4
277581	.012024							4
277583	.012076							3
277595	.012006							2
277599	.012011							3
277617	.012028							30
277759	.012008							2
278194	.012026							4
375605	.012109							3
376072	.012060							2
376506	.012076							3
376732	.012024							4
376735	.012109							3
376737	.012076							3
376738	.012027							4, 43
376777	.012060							2
376805	.012011							3
376841	.012109							3
376917	.012028							30
376968	.012060							2
377410	.012023							4
377632	.012060							2
377635	.012007							2
377636	.012011							3
377978	.012044							6, 43
378039	.012045							6, 43
378040	.012043							6, 43
378571	.012026							4
378579	.012025							4
378580	.012022							4
378581	.012023							4
379260	.012042							6, 43
379717	.012109							3
380104	.012004							2
380637	.012024							4
380958	.012005							2
381185	.012091							43
381186	.012092							43
381187	.012093							43
381446	.012044							6, 43
381801	.012011							3
382017	.012090							7, 43
382676	.012089							7, 43
382761	.012047							6, 7, 38, 43
382762	.011001							6, 7, 38, 43
382763	.011002	.013076			.992103	.993103	.106	6, 7, 38, 43







# MICHIGAN WHEEL OEM CROSS REFERENCE

Original Equipment Manufacturer Part & Trade Mark	Standard Hub Propellers				XHS Hub Propellers			Catalog Page #
								
<b>EVINRUDE, JOHNSON, OMC (continued)</b>								
382764	.011003	.013077			.992104	.993104	.106	6, 7, 38, 43
382765	.011004	.013078			.992105	.993105	.106	6, 7, 38, 43
382766	.011005	.013079			.992106	.993106	.106	6, 7, 38, 43
382768					.992106	.993106	.106	6, 7, 38, 43
383287	.012094							43
383315	.012008							2
383629	.012011							3
384139	.SST® .013030	.013077				.993104	.106	6, 7, 38, 43
384140	.011005	.013079			.992106	.993106	.106	6, 7, 38, 43
384141	.SST® .013034	.013079				.993106	.106	6, 7, 38, 43
384142	.SST® .013033	.013078				.993105	.106	6, 7, 38, 43
384144	.SST® .013028	.013076				.993103	.106	6, 7, 38, 43
384460	.012028							30
384702	.SST® .013034	.013079				.993106	.106	6, 7, 38, 43
3850299	.161001	.163012	.346031		.992002	.993002	.105	47
3850300	.161002	.163014	.346032		.992003	.993003	.105	47
3850301	.161003	.163016	.346033		.992004	.993004	.105	47
3850302					.992005	.993005	.105	47
385319	.012005							2
385940	.SST® .012008							2
385955	.012023							4
386118	.012111							3
386317	.012054				.992501		.118	3
386637	.012055							3
386669	.012113							3
386786	.012038	.013082			.992302		.111	5
386841	.012039	.013083			.992303		.111	5
386907	.012036	.013080						5
386908	.012040	.013084						5
386909	.012037	.013081			.992301		.111	5
386933	.012056							3
386955	.012005							2
386980	.SST® .013026	.013083						5
386981	.SST® .013010	.013082						5
386982	.SST® .013024	.013081						5
387158	.011016							8, 9, 39, 40, 41, 42, 44, 45
387159	.011006	.013064			.992002	.993002	.See Note 2	8, 9, 39, 40, 41, 42, 44, 45
387160	.011007	.013066			.992003	.993003	.See Note 2	8, 9, 39, 40, 41, 42, 44, 45
387161	.011008	.013068			.992004	.993004	.See Note 2	8, 9, 39, 40, 41, 42, 44, 45
387162	.011009	.013070			.992005	.993005	.See Note 2	8, 9, 39, 40, 41, 42, 44, 45
387163	.011010	.013072			.992006	.993006	.See Note 2	8, 9, 39, 40, 41, 42, 44, 45
387320	.012053							3
387334	.012008							2
387519	.SST® .013046	.013068				.993004	.See Note 2	8, 9, 39, 40, 41, 42, 44, 45
387520	.SST® .013048	.013070				.993005	.See Note 2	8, 9, 39, 40, 41, 42, 44, 45
387636	.012056							3
388088	.012013							3
388294	.012102							3
388883	.012016							3
389019	.SST II® .013050	.013072	.345035			.993006	.See Note 2	8, 9, 39, 40, 41, 42, 44, 45
389029	.SST® .013032	.013084						5
389068	.012021							3
389069	.012015							3
389510	.SST II® .013033	.013078				.993105	.106	6, 7, 38, 43
389512	.SST II® .013034	.013079				.993106	.106	6, 7, 38, 43
389619	.012015							3
389627	.012101							2
389788	.011005	.013079			.992106	.993106	.106	6, 7, 38, 43







# MICHIGAN WHEEL OEM CROSS REFERENCE

Original Equipment Manufacturer Part & Trade Mark	Standard Hub Propellers				XHS Hub Propellers			Catalog Page #
								
<b>EVINRUDE, JOHNSON, OMC (continued)</b>								
389855	.012023							4
389923	.SST II® .013048	.013070	.345034			.993005	.See Note 2	8, 9, 39, 40, 41, 42, 44, 45
389924	.SST II® .013046	.013068	.345033			.993004	.See Note 2	8, 9, 39, 40, 41, 42, 44, 45
389925	.SST®		.345032					8, 9, 39, 40, 41, 42, 44, 45
389944	.012030							3
389948	.SST II® .013030	.013077				.993104	.106	6, 7, 38, 43
389949	.SST II® .013028	.013076	.335030			.993103	.106	6, 7, 38, 43
390113	.SST® .013033	.013078				.993105	.106	6, 7, 38, 43
390114	.SST® .013030	.013077				.993104	.106	6, 7, 38, 43
390237	.012032							2
390380	.012057		.305030					3
390725	.SST®		.345036					33,55,57
390729	.SST®		.305029					3
390730	.SST®		.305030					3
390821	.SST II® (LH) .013045	.013069	.345063			.993014	.See Note 2	8, 9, 39, 40, 41, 42, 44, 45
390822	.SST II® (LH) .013047	.013071	.345064			.993015	.See Note 2	8, 9, 39, 40, 41, 42, 44, 45
390823	.SST II® (LH)	.013073	.345065			.993016	.See Note 2	8
390830	.012031							2
390833	.012024							4
390849	.SST® .013024	.013081						5
390850	.SST® .013010	.013082	.325030					5
390851	.SST® .013026	.013083	.325031					5
390852	.SST® .013032	.013084						5
390896	.011004	.013078			.992105	.993105	.106	6, 7, 38, 43
391096	.012031							2
391198	.011002	.013076	.335030		.992103	.993103	.106	6, 7, 38, 43
391199	.011003	.013077			.992104	.993104	.106	6, 7, 38, 43
391200	.011007	.013066	.345032		.992003	.993003	.See Note 2	8, 9, 39, 40, 41, 42, 44, 45
391201	.011008	.013068	.345033		.992004	.993004	.See Note 2	8, 9, 39, 40, 41, 42, 44, 45
391202	.011009	.013070	.345034		.992005	.993005	.See Note 2	8, 9, 39, 40, 41, 42, 44, 45
391203	.011010	.013072	.345035		.992006	.993006	.See Note 2	8, 9, 39, 40, 41, 42, 44, 45
391290	.SST II® .013044	.013066	.345032			.993003	.See Note 2	8, 9, 39, 40, 41, 42, 44, 45
391534	.012101							2
391535	.011006	.013064	.345031		.992002	.993002	.See Note 2	8, 9, 39, 40, 41, 42, 44, 45
391536	.011016							8, 9, 39, 40, 41, 42, 44, 45
391668	.011001							6, 7, 38, 43
393160	.Aluminum .011025	.013078			.992105	.993105	.106	6, 7, 38, 43
394752	.Raker®	.013066	.345032			.993003	.See Note 2	8, 9, 39, 40, 41, 42, 44, 45
394753	.Raker®	.013068	.345033			.993004	.See Note 2	8, 9, 39, 40, 41, 42, 44, 45
394754	.Raker®	.013070	.345034	.345041		.993005	.See Note 2	8, 9, 39, 40, 41, 42, 44, 45
394755	.Raker®	.013072	.345035	.345037		.993006	.See Note 2	8, 9, 39, 40, 41, 42, 44, 45
394756	.Raker®	.013074	.345036	.345038		.993007	.See Note 2	8, 9, 39, 40, 41, 42, 44, 45
394758	.Raker®	.013077	.335032			.993104	.106	31,32,55,57
394759	.Raker®	.013078	.335033			.993105	.106	6, 7, 38
394760	.Raker®	.013079		.335034		.993106	.106	7
394761	.Raker®			.335035				7
398126	.012112							3
398502	.Raker® (LH)	.013069	.345063			.993014	.See Note 2	8
398503	.Raker® (LH)	.013071	.345064			.993015	.See Note 2	8
398504	.Raker® (LH)	.013073				.993016	.See Note 2	33,55,56,57
398505	.Raker® (LH)	.013075				.993017	.See Note 2	33,55,56,57
431717	.SHOOTER® .013036			.435035				8, 9
431718	.SHOOTER® .013038			.435036				8, 9
431930	.SST II® (LH) .013043	.013067	.345062			.993013	.See Note 2	8, 9, 39, 40, 41, 42, 44, 45
591389	.012060							2
591920	.012024							4
591925	.012076							3
591978	.012060							2







# MICHIGAN WHEEL OEM CROSS REFERENCE

Original Equipment Manufacturer Part & Trade Mark	Standard Hub Propellers				XHS Hub Propellers			Catalog Page #
								
<b>EVINRUDE, JOHNSON, OMC (continued)</b>								
592038	.012076							3
592063	.012060							2
592959	.012076							3
QA2002X	.011015							8, 9, 39, 40
QA2004X	.011016							8, 9, 39, 40, 41, 42, 44, 45
QA3008X	.011006		.345031		.992002	.993002	.See Note 2	8, 9, 39, 40, 41, 42, 44, 45
QA3012X	.011007		.345032		.992003	.993003	.See Note 2	8, 9, 39, 40, 41, 42, 44, 45
QA3016X	.011008		.345033		.992004	.993004	.See Note 2	8, 9, 39, 40, 41, 42, 44, 45
QA3018X	.011009		.345034		.992005	.993005	.See Note 2	8, 9, 39, 40, 41, 42, 44, 45
QA3020X	.011010		.345035		.992006	.993006	.See Note 2	8, 9, 39, 40, 41, 42, 44, 45
QA3030R	Black Diamond .012047							6, 7, 38, 43
QA3032R	Black Diamond .011001							6, 7, 38, 43
QA3034R	Black Diamond .011002	.013076	.335030		.992104	.993103	.106	6, 7, 38, 43
QA3036R	Black Diamond .011003	.013077	.335031		.992104	.993104	.106	6, 7, 38, 43
QA3038R	Black Diamond .011024		.335031		.992104	.993104	.106	6, 7, 38, 43
QA3040R	Black Diamond .011004	.013078	.335032		.992105	.993105	.106	6, 7, 38, 43
QA3042R	.011025		.335032		.992105	.993105	.106	6, 7, 38, 43
QA3046R	.011005		.335033		.992106	.993106	.106	6, 7, 38, 43
QA3048R	.011026		.335033		.992106	.993106	.106	6, 7, 38, 43
QA3080R	.012036	.013080						5
QA3082R	.012037	.013081						5
QA3084R	.011027	.013082	.325030					5
QA3084R	.012038	.013082	.325030					5
QA3088R	.011028	.013083	.325031					5
QA3088R	.012039	.013083	.325031					5
QA3090R	.011029							5
QA3100R	.012024							4
QA3102R	.012028							4
QA3114R	.012055							3
QA3118R	.012056							3
QA3122R	.012057							3
QA3136R	.012016							3
QA3138R	.012030							3
QA3150R	Black Diamond .012011							3
QA3152R	Black Diamond .012013							3
QA3168R	.012111							3
QA3178R	.012008							2
QA3190R	.012032							2
QA9090R	.012040							5
QS5050X	.013052		.345031		.992002	.993002	.See Note 2	8, 9, 39, 40, 41, 42, 44, 45
QS5052X	.013044		.345032		.992003	.993003	.See Note 2	8, 9, 39, 40, 41, 42, 44, 45
QS5053X			.345062			.993013	.See Note 2	8, 9, 39, 40, 41, 42, 44, 45
QS5053X	.013043							8, 9, 39, 40, 41, 42, 44, 45
QS5054X	.013046		.345033					8, 9, 39, 40, 41, 42, 44, 45
QS5055X	.013045		.345063					8, 9, 39, 40, 41, 42, 44, 45
QS5056X	.013048		.345034					8, 9, 39, 40, 41, 42, 44, 45
QS5057X	.013047		.345064					8, 9, 39, 40, 41, 42, 44, 45
QS5058X	.013050		.345035					8, 9, 39, 40, 41, 42, 44, 45
QS5070X			.345033		.992002	.993004	.See Note 2	8, 9, 39, 40, 41, 42, 44, 45
QS5071X			.345063			.993014	.See Note 2	8, 9, 39, 40, 41, 42, 44, 45
QS5072X			.345034		.992005	.993005	.See Note 2	8, 9, 39, 40, 41, 42, 44, 45
QS5073X			.345064			.993015	.See Note 2	8, 9, 39, 40, 41, 42, 44, 45
QS5074X			.345035	.345041	.992006	.993006	.See Note 2	8, 9, 39, 40, 41, 42, 44, 45
QS5075X			.345065			.993016	.See Note 2	8, 9, 39, 40, 41, 42, 44, 45
QS5076X			.345036	.345037		.993007	.See Note 2	8, 9, 39, 40, 41, 42, 44, 45
QS5077X						.993017	.See Note 2	8, 9, 39, 40, 41, 42, 44, 45
QS5136H	.013028		.335030		.992103	.993103	.See Note 2	6, 7, 38, 43
QS5138H	.013030		.335031		.992104	.993104	.See Note 2	6, 7, 38, 43







# MICHIGAN WHEEL OEM CROSS REFERENCE

Original Equipment Manufacturer Part & Trade Mark	Standard Hub Propellers				XHS Hub Propellers			Catalog Page #
								
<b>EVINRUDE, JOHNSON, OMC (continued)</b>								
QS5140H	.013033		.335032		.992105	.993105	.See Note 2	6, 7, 38, 43
QS5142H	.013034		.335033	.335034	.992106	.993106	.See Note 2	6, 7, 38, 43
QS5144H				.335035				6, 7, 38, 43
TA2002X	.011015							8, 9, 39, 40
TA2230T	.032042	.033095	.395929					4
TA3030T	.012047							6, 7, 38, 43
TA3032T	.011001							6, 7, 38, 43
TA3034T	.011002	.013076	.335030		.992103	.993103	.106	6, 7, 38, 43
TA3036T	.011003	.013077	.335031		.992104	.993104	.106	6, 7, 38, 43
TA3038T	.011024	.013077	.335031		.992104	.993104	.106	6, 7, 38, 43
TA3040T	.011004	.013078	.335032		.992105	.993105	.106	6, 7, 38, 43
TA3150T	.012011							3
TA3152T	.012013							3
<b>FORCE, CHRYSLER, U.S. MARINE</b>								
48-16986A45	.033016	.033084	.335130			.993103	.See Note 3	13
48-16986A5	.033016	.033084	.335130			.993103	.See Note 3	13
48-16988A40	.033017	.033085	.335131			.993104	.See Note 3	13
48-16988A45	.033017	.033085	.335131			.993104	.See Note 3	13
48-16990A40	.033018	.033086	.335132			.993105	.See Note 3	13
48-16990A45	.033018	.033086	.335132			.993105	.See Note 3	13
48-16992A40	.033019	.033087	.335133			.993106	.See Note 3	3
48-16992A45	.033019	.033087	.335133			.993106	.See Note 3	13
48-19636A10					.992501		.120	11
48-19638A40	.031049				.992503		.120	11
48-19639A40					.992504		.120	11
48-19640A40	.031048		.305129		.992505		.120	11
48-19642A40	.031047		.305130		.992506		.120	11
48-42738A10	.032141							11
48-42740A10	.032142							11
48-64724A1	.031020							11
48-64724A4	.031020							11
48-73132A4	.031015	.033088						11
48-73132A40	.031015	.033088						11
48-73134A4	.031016	.033089			.992405		.114	11
48-73134A40	.031016	.033089			.992405		.114	11
48-73136A4	.031017	.033090	.395129		.992406		.114	11
48-73136A40	.031017	.033090	.395129		.992406		.114	11
48-73138A4	.031018	.033091			.992407		.114	11
48-73138A40	.031018	.033091			.992407		.114	11
48-73140A4	.031019	.033092	.395130		.992408		.114	11
48-73140A40	.031019	.033092	.395130		.992408		.114	11
48-73142A40					.992409		.114	11
48-73144A4	.031020							11
48-73144A40	.031020							11
48-76228A4		.033090	.395129					11
48-76228A5		.033090	.395129					11
48-76230A4	.033028	.033091						11
48-76230A5	.033028	.033091						11
48-76232A4		.033092	.395130					11
48-76232A5		.033092	.395130					11
48-77338A40	.031054							13
48-77338A45	.031054							13
48-77340A40	.031055							13
48-77340A45	.031055							13
48-77342A40	.031041	.033084	.335130		.992103	.993103	.See Note 3	13
48-77342A45	.031041	.033084	.335130		.992103	.993103	.See Note 3	13
48-77344A40	.031042	.033085	.335131		.992104	.993104	.See Note 3	13

# MICHIGAN WHEEL OEM CROSS REFERENCE







Original Equipment Manufacturer Part & Trade Mark	Standard Hub Propellers				XHS Hub Propellers			Catalog Page #
								
<b>FORCE, CHRYSLER, U.S. MARINE (continued)</b>								
48-77344A45 . . . . .Black Max™	. . .031042	. . .033085	. . .335131	. . . . .	. . .992104	. . .993104	.See Note 3 . .	13
48-77346A40 . . . . .	. . .031043	. . .033086	. . .335132	. . . . .	. . .992105	. . .993105	.See Note 3 . .	13
48-77346A45 . . . . .Black Max™	. . .031043	. . .033086	. . .335132	. . . . .	. . .992105	. . .993105	.See Note 3 . .	13
48-77348A40 . . . . .	. . .031044	. . .033087	. . .335133	. . . . .	. . .992106	. . .993106	.See Note 3 . .	13
48-77348A45 . . . . .Black Max™	. . .031044	. . .033087	. . .335133	. . . . .	. . .992106	. . .993106	.See Note 3 . .	13
48-77350A40 . . . . .	. . .031045	. . . . .	. . . . .	. . . . .	. . . . .	. . . . .	. . . . .	13
48-77350A45 . . . . .Black Max™	. . .031045	. . . . .	. . . . .	. . . . .	. . . . .	. . . . .	. . . . .	13
48-77350A45 . . . . .Black Max™	. . .031045	. . . . .	. . . . .	. . . . .	. . . . .	. . . . .	. . . . .	13
48-79792A4 . . . . .QSS™	. . .033001	. . .033089	. . . . .	. . . . .	. . . . .	. . . . .	. . . . .	11
48-79792A5 . . . . .Vengeance	. . .033001	. . .033089	. . . . .	. . . . .	. . . . .	. . . . .	. . . . .	11
48-816702A40 . . . . .	. . .031056	. . .033089	. . . . .	. . . . .	. . . . .	. . . . .	. . . . .	11
48-816704A40 . . . . .	. . .031057	. . .033090	. . .395129	. . . . .	. . . . .	. . . . .	. . . . .	11
48-816706A40 . . . . .	. . .031058	. . .033091	. . . . .	. . . . .	. . . . .	. . . . .	. . . . .	11
48-819334A40 . . . . .	. . .072133	. . . . .	. . . . .	. . . . .	. . . . .	. . . . .	. . . . .	11
48-819335A40 . . . . .	. . .072132	. . . . .	. . . . .	. . . . .	. . . . .	. . . . .	. . . . .	11
48-819336A40 . . . . .	. . .072131	. . . . .	. . . . .	. . . . .	. . . . .	. . . . .	. . . . .	11
48-819337A40 . . . . .	. . .072014	. . . . .	. . . . .	. . . . .	. . . . .	. . . . .	. . . . .	10, 11
48-819337A45 . . . . .	. . .072014	. . . . .	. . . . .	. . . . .	. . . . .	. . . . .	. . . . .	10, 11
48-855858A5 . . . . .Vengeance	. . .031057	. . .033090	. . . . .	. . . . .	. . . . .	. . . . .	. . . . .	11
48-85632A40 . . . . .Black Max™	. . .031053	. . . . .	. . . . .	. . . . .	. . .992404	. . . . .114	. . . . .	11
48-FP19 . . . . .	. . .072017	. . . . .	. . . . .	. . . . .	. . . . .	. . . . .	. . . . .	10
48-FP372 . . . . .	. . .072033	. . . . .	. . . . .	. . . . .	. . . . .	. . . . .	. . . . .	12
48-FP488 . . . . .Black Max™	. . .072123	. . . . .	. . . . .	. . . . .	. . . . .	. . . . .	. . . . .	10
48-FP6430 . . . . .Black Max™	. . .072026	. . . . .	. . . . .	. . . . .	. . . . .	. . . . .	. . . . .	10
48-FP669-1 . . . . .	. . .071035	. . . . .	. . . . .	. . . . .	. . . . .	. . . . .	. . . . .	13
48-FP669-2 . . . . .	. . .071035	. . . . .	. . . . .	. . . . .	. . . . .	. . . . .	. . . . .	13
48-FP669-3 . . . . .	. . .071035	. . . . .	. . . . .	. . . . .	. . . . .	. . . . .	. . . . .	13
48-FP685-1 . . . . .	. . .071036	. . . . .	. . . . .	. . . . .	. . . . .	. . . . .	. . . . .	13
48-FP685-2 . . . . .	. . .071036	. . . . .	. . . . .	. . . . .	. . . . .	. . . . .	. . . . .	13
48-FP685-3 . . . . .	. . .071036	. . . . .	. . . . .	. . . . .	. . . . .	. . . . .	. . . . .	13
48-FP686-1 . . . . .	. . .071037	. . . . .	. . . . .	. . . . .	. . . . .	. . . . .	. . . . .	13
48-FP686-3 . . . . .	. . .071037	. . . . .	. . . . .	. . . . .	. . . . .	. . . . .	. . . . .	13
48-FP686-4 . . . . .	. . .071037	. . . . .	. . . . .	. . . . .	. . . . .	. . . . .	. . . . .	13
48-FP692-1 . . . . .	. . .072127	. . . . .	. . . . .	. . . . .	. . . . .	. . . . .	. . . . .	13
48-FP692-2 . . . . .	. . .072127	. . . . .	. . . . .	. . . . .	. . . . .	. . . . .	. . . . .	13
48-FP692-3 . . . . .	. . .072127	. . . . .	. . . . .	. . . . .	. . . . .	. . . . .	. . . . .	13
48-FP694 . . . . .	. . .071038	. . . . .	. . . . .	. . . . .	. . . . .	. . . . .	. . . . .	13
48-FP70 . . . . .Black Max™	. . .072024	. . . . .	. . . . .	. . . . .	. . . . .	. . . . .	. . . . .	10
FA282265 . . . . .	. . .072132	. . . . .	. . . . .	. . . . .	. . . . .	. . . . .	. . . . .	11
FA287265 . . . . .	. . .072131	. . . . .	. . . . .	. . . . .	. . . . .	. . . . .	. . . . .	11
FA378265 . . . . .	. . .072132	. . . . .	. . . . .	. . . . .	. . . . .	. . . . .	. . . . .	11
FP273 . . . . .	. . .072133	. . . . .	. . . . .	. . . . .	. . . . .	. . . . .	. . . . .	11
FP274 . . . . .	. . .072014	. . . . .	. . . . .	. . . . .	. . . . .	. . . . .	. . . . .	10, 11
FP276 . . . . .	. . .072014	. . . . .	. . . . .	. . . . .	. . . . .	. . . . .	. . . . .	10, 11
FP277 . . . . .	. . .072131	. . . . .	. . . . .	. . . . .	. . . . .	. . . . .	. . . . .	11
FP278 . . . . .	. . .072014	. . . . .	. . . . .	. . . . .	. . . . .	. . . . .	. . . . .	10, 11
FP282 . . . . .	. . .072132	. . . . .	. . . . .	. . . . .	. . . . .	. . . . .	. . . . .	11
FP286 . . . . .	. . .072026	. . . . .	. . . . .	. . . . .	. . . . .	. . . . .	. . . . .	10
FP287 . . . . .	. . .072131	. . . . .	. . . . .	. . . . .	. . . . .	. . . . .	. . . . .	11
FP293 . . . . .	. . .072132	. . . . .	. . . . .	. . . . .	. . . . .	. . . . .	. . . . .	11
FP319 . . . . .	. . .072121	. . . . .	. . . . .	. . . . .	. . . . .	. . . . .	. . . . .	10
FP327 . . . . .	. . .072121	. . . . .	. . . . .	. . . . .	. . . . .	. . . . .	. . . . .	10
FP328 . . . . .	. . .072014	. . . . .	. . . . .	. . . . .	. . . . .	. . . . .	. . . . .	10, 11
FP330 . . . . .	. . .072026	. . . . .	. . . . .	. . . . .	. . . . .	. . . . .	. . . . .	10
FP366 . . . . .	. . .072014	. . . . .	. . . . .	. . . . .	. . . . .	. . . . .	. . . . .	10, 11
FP372 . . . . .	. . .072033	. . . . .	. . . . .	. . . . .	. . . . .	. . . . .	. . . . .	12
FP378 . . . . .	. . .072132	. . . . .	. . . . .	. . . . .	. . . . .	. . . . .	. . . . .	11
FP383 . . . . .	. . .072034	. . . . .	. . . . .	. . . . .	. . . . .	. . . . .	. . . . .	12

# MICHIGAN WHEEL OEM CROSS REFERENCE







Original Equipment Manufacturer Part & Trade Mark	Standard Hub Propellers				XHS Hub Propellers			Catalog Page #
								
<b>FORCE, CHRYSLER, U.S. MARINE (continued)</b>								
FP389	.072032							12
FP395 Black Max™	.072121							10
FP408	.072026							10
FP472 Black Max™	.072122							10
FP501	.072054							12
FP509	.073008							13
FP510	.073004							12
FP511	.073010							13
FP519	.072055							12
FP523	.072107							12
FP524	.072108							12
FP526	.072109							12
FP539	.073003							12
FP540	.073004							12
FP623	.072107							12
FP654	.072108							12
FP664	.073007							13
FP665	.071035							13
FP668	.073008							13
FP669	.071035							13
FP669-1	.071035							13
FP682	.072127							13
FP685	.072128							13
FP685-1	.072128							13
FP686	.072129							13
FP686-1	.071037							13
FP686-2	.072129							13
FP692	.072127							13
FP692-1	.072127							13
FP694	.071038							13
FP696	.073010							13
FP699	.073007							13
FPM736	.031020							11
FPM738	.031019	.033092						11
FPM752 QSS™	.033028	.033091						11
FPM754 QSS™	.033001	.033089						11
FPM756	.031015	.033088						11
FPS501	.072054							12
FPS509	.073008							13
FPS510	.073004							12
FPS511	.073010							13
FPS519	.072055							12
FPS523	.072107							12
FPS524	.072108							12
FPS526	.072109							12
FPS623	.072107							12
FPS625	.072108							12
FPS626	.072109							12
FPS654	.072108							12
FPS686	.072129							13
FS501265	.072054							12
QA2028X	.031043				.992105	.993105	.See Note 3	13
QA2030X	.031054							13
QA2032X	.031055							13
QA2034X	.031041				.992103	.993103	.See Note 3	13
QA2036X	.031042				.992104	.993104	.See Note 3	13
QA2040X	.031044				.992106	.993106	.See Note 3	13
QA2042X	.031045							13









# MICHIGAN WHEEL OEM CROSS REFERENCE

Original Equipment Manufacturer Part & Trade Mark	Standard Hub Propellers				XHS Hub Propellers			Catalog Page #
								
<b>FORCE, CHRYSLER, U.S. MARINE (continued)</b>								
QA2060R	.032141							11
QA2064R	.031015	.033088						11
QA2066R	.032142							11
QA2070R	.031053	.033089						11
QA2072R	.031056	.033089						11
QA2074R	.031016	.033089						11
QA2076R	.031057	.033090	.395129					11
QA2078R	.031017	.033090	.395129					11
QA2080R	.031058	.033091						11
QA2082R	.031018	.033091						11
QA2084R	.031019	.033092	.395130					11
QA2088R	.031020							11
QA2102R	.031049							11
QA2106R	.031048		.305129					11
QA2108R	.031047		.305130					11
QS5116X	.033016		.335130		.992103	.993103	.102	13
QS5118X	.033017		.335131		.992104	.993104	.102	13
QS5120X	.033018		.335132		.992105	.993105	.102	13
QS5122X	.033019		.335133	.335134	.992106	.993106	.102	13
QS5124X				.335135				13
QS5164R	.033001							11
QS5164R		.033089						11
QS5166R		.033090	.395129					11
QS5168R	.033028	.033091	.395130					11
QS5168R		.033091	.395130					11
QS5170R		.033092	.395130					11
TA2034	Black Diamond .031041	.033084			.992103	.993103	.See Note 3	13
TA2036	Black Diamond .031042	.033085			.992104	.993104	.See Note 3	13
TA2038	Black Diamond .031043	.033086			.992105	.993105	.See Note 3	13
TA2040	Black Diamond .031044	.033087			.992106	.993106	.See Note 3	13
TA2060T	Black Diamond .032141							11
TA2064T	Black Diamond .031015	.033088						11
TA2070T	Black Diamond .031053							11
TA2072T	Black Diamond .031053							11
TA2076T	Black Diamond .031057	.033090	.395129					11
TA2080T	Black Diamond .031058	.033091						11
TA2084T	Black Diamond .031019	.033092	.395130					11
TA2102T	Black Diamond .031049							11
TA2106T	Black Diamond .031048							11
TS1116	Silverado .033016	.033084	.335130			.993103	.See Note 3	13
TS1118	Silverado .033017	.033085	.335131			.993104	.See Note 3	13
TS1120	Lightspeed	.033086	.335132			.993105	.See Note 3	13
TS1122	Lightspeed	.033087	.335133			.993106	.See Note 3	13
TS1164T	Silverado .033001	.033089						11
TS1166T	Silverado	.033090	.395129					11
TS1168T	Silverado .033028	.033091						11
<b>HONDA</b>								
08M60-ZW7-A00		.033084	.335130			.993103	.See Note 3	15
08M60-ZW7-A10		.033085	.335131			.993104	.See Note 3	15
08M60-ZW7-A20		.033086	.335132			.993105	.See Note 3	15
08M60-ZW7-A30		.033087	.335133			.993106	.See Note 3	15
58110-ZV4-300	.102005							14
58110-ZV4-DT15	.112004							14
58110-ZV5-E00		.033097	.395930					15
58110-ZV5-E10		.033096						15
58110-ZV5-E20		.033095	.395929					15
58110-ZV5-E30		.033094						15







# MICHIGAN WHEEL OEM CROSS REFERENCE

Original Equipment Manufacturer Part & Trade Mark	Standard Hub Propellers				XHS Hub Propellers			Catalog Page #
								
<b>HONDA (continued)</b>								
58130-881-840ZA	.012109							14
58130-881-840ZB	.012109							14
58130-935-000N	.012109							14
58130-935-600N	.012109							14
58130-ZV4-000ZA	.102005							14
58130-ZV4-010ZA	.102005							14
58130-ZV4-020ZA	.102005							14
58130-ZV4-030ZA	.102005							14
58130-ZV4-030ZB	.102005							14
58130-ZV4-700ZA	.102004							14
58130-ZV4-701ZA	.102004							14
58130-ZV4-702ZA	.102004							14
58130-ZV4-703ZA	.102004							14
58130-ZV4-703ZB	.102004							14
58130-ZV5-000ZA	.032042	.033095	.395929					15
58130-ZV5-011AH					.992404		.113	15
58130-ZV5-012AH					.992405		.113	15
58130-ZV5-013AH					.992406		.113	15
58130-ZV5-014AH					.992407		.113	15
58130-ZV5-015AH					.992408		.113	15
58130-ZV5-850ZA	.032043	.033094						15
58130-ZV5-860ZA	.032045	.033093						15
58130-ZV5-870ZA	.032040	.033097	.395930					15
58130-ZV7-009AH					.992501		.119	14
58130-ZV7-010AH					.992502		.119	14
58130-ZV7-011AH					.992503		.119	14
58130-ZV7-012AH					.992504		.119	14
58130-ZW1-V01	.033017	.033085	.335131			.993104	.See Note 3	15,16
58130-ZW1-V11	.033018	.033086	.335132			.993105	.See Note 3	15,16
58130-ZW1-V31	.033019	.033087	.335133			.993106	.See Note 3	15,16
58130-ZW1-W01ZA	.031054							15,16
58130-ZW1-W11ZA	.031055							15,16
58130-ZW1-W21ZA	.031041	.033084	.335130		.992103	.993103	.See Note 3	15,16
58130-ZW1-W31ZA	.031042	.033085	.335131		.992104	.993104	.See Note 3	15,16
58130-ZW1-W41ZA	.031044	.033087	.335133		.992106	.993106	.See Note 3	15,16
58130-ZW1-W51ZA	.031045							15,16
58130-ZW1-W61ZA	.031043	.033086	.335132		.992105	.993105	.See Note 3	15,16
58130-ZW1-W91	.033016	.033084	.335130			.993103	.See Note 3	15,16
58133-ZV5-010AH		.033093						15
58133-ZV5-012AH		.033094						15
58133-ZV5-013AH		.033095	.395929					15
58133-ZV5-014AH		.033096						15
58133-ZV5-015AH		.033096						15
58133-ZW1-A15AH		.033084	.335130		.992103	.993103	.See Note 3	15,16
58133-ZW1-A17AH		.033085	.335131		.992104	.993104	.See Note 3	15,16
58133-ZW1-A19AH		.033086	.335132		.992105	.993105	.See Note 3	15,16
58134-ZV5-009AH					.992402		.113	15
58134-ZV5-010AH					.992403		.113	15
QA2028X	.031043				.992105	.993105	.See Note 3	15,16
QA2030X	.031054							15,16
QA2032X	.031055							15,16
QA2034X	.031041				.992103	.993103	.See Note 3	15,16
QA2036X	.031042				.992104	.993104	.See Note 3	15,16
QA2040X	.031044				.992106	.993106	.See Note 3	15,16
QA2042X	.031045							15,16
QA2064R	.032044							15
QA2064R	.032045	.033093						15
QA2078R	.032042	.033095	.395929					15







# MICHIGAN WHEEL OEM CROSS REFERENCE

Original Equipment Manufacturer Part & Trade Mark	Standard Hub Propellers				XHS Hub Propellers			Catalog Page #
								
<b>HONDA (continued)</b>								
QA2078R	.032043	.033094						15
QA2082R	.032041	.033096						15
QA2084R	.032040	.033097	.395930					15
QA2084R	.032039							15
QA2226R	.032044							15
QA2230R	.032042	.033095	.395929					15
QA2232R	.032041	.033096						15
QA2234R	.032040	.033097	.935930					15
QA3150R	.012011							14
QA3152R	.012013							14
QA3902R	.102003							14
QA3906R	.102004							14
QA3914R	.102005							14
QS5116X	.033016		.335130		.992103	.993103	.102	15
QS5118X	.033017		.335131		.992104	.993104	.102	15
QS5120X	.033018		.335132		.992105	.993105	.102	15
QS5122X	.033019		.335133		.992106	.993106	.102	15
QS5164R		.033094						15
QS5164R	.113001	.033094						15
QS5166R		.033095	.395929					15
QS5168R		.033096						15
QS5170R		.033097	.395930					15
TA3150T	.012011							14
TA3152T	.012013							14
TA3902T	.102003							14
TA3906T	.102003							14
TA3914T	.102005							14
<b>MERCURY, MARINER, MERCUISER</b>								
48-11070A40	.Laser™	.033078				.993005	.102	21, 34, 35
48-11074A40	.Laser™	.033080				.993006	.102	21, 34, 35
48-11320A40		.031050	.033072		.992002	.993002	.102	21, 34, 35
48-11322A40		.031051	.033074		.992003	.993003	.102	21, 34, 35
48-11324A40		.031052	.033076		.992004	.993004	.102	21, 34, 35
48-11324A45	.Black Max™	.031052	.033076		.992004	.993004	.102	21, 34, 35
48-13242A5	.Mirage®	.033052						36
48-13242A50	.Mirage®	.033052						36
48-13243A5	.Mirage®(LH)	.033053						36
48-13243A50	.Mirage®(LH)	.033053						36
48-13244A5	.Mirage®	.033054						36
48-13244A50	.Mirage®	.033054						36
48-13245A5	.Mirage®(LH)	.033055						36
48-13245A50	.Mirage®(LH)	.033055						36
48-13247A5	.Mirage®(LH)	.033057						36
48-13247A50	.Mirage®(LH)	.033057						36
48-13248A5	.Mirage®	.033058						36
48-13248A50	.Mirage®	.033058						36
48-13701A40	.Mirage®(LH)	.033029	.345163					36
48-13701A41	.Mirage®(LH)	.033029	.345163					36
48-13701A45	.Mirage®Plus(LH)	.033029	.345163					36
48-13702A40	.Mirage®	.033032	.345134					36
48-13702A41	.Mirage®	.033032	.345134					36
48-13702A45	.Mirage®Plus	.033032	.345134					36
48-13702A46	.Mirage®Plus	.033032	.345134					36
48-13702A55	.Mirage®Plus	.033054	.345134					36
48-13703A40	.Mirage®(LH)	.033031	.345164					36
48-13703A41	.Mirage®(LH)	.033031	.345164					36
48-13703A45	.Mirage®Plus(LH)	.033031	.345164					36







# MICHIGAN WHEEL OEM CROSS REFERENCE

Original Equipment Manufacturer Part & Trade Mark	Standard Hub Propellers				XHS Hub Propellers			Catalog Page #
								
<b>MERCURY, MARINER, MERCUISER (continued)</b>								
48-13703A55 . . . . .Mirage®Plus(LH)	. . . . .033053	. . . . .	. . . . .345164	. . . . .	. . . . .	. . . . .	. . . . .	36
48-13704A40 . . . . .Mirage®	. . . . .033034	. . . . .	. . . . .345135	. . . . .	. . . . .	. . . . .	. . . . .	36
48-13704A41 . . . . .Mirage®	. . . . .033034	. . . . .	. . . . .345135	. . . . .	. . . . .	. . . . .	. . . . .	36
48-13704A45 . . . . .Mirage®Plus	. . . . .033034	. . . . .	. . . . .345135	. . . . .	. . . . .	. . . . .	. . . . .	36
48-13704A46 . . . . .Mirage®Plus	. . . . .033034	. . . . .	. . . . .345135	. . . . .	. . . . .	. . . . .	. . . . .	36
48-13705A40 . . . . .Mirage®(LH)	. . . . .033033	. . . . .	. . . . .345165	. . . . .	. . . . .	. . . . .	. . . . .	36
48-13705A41 . . . . .Mirage®(LH)	. . . . .033033	. . . . .	. . . . .345165	. . . . .	. . . . .	. . . . .	. . . . .	36
48-13705A45 . . . . .Mirage®Plus(LH)	. . . . .033033	. . . . .	. . . . .345165	. . . . .	. . . . .	. . . . .	. . . . .	36
48-13705A55 . . . . .Mirage®Plus(LH)	. . . . .033033	. . . . .	. . . . .345165	. . . . .	. . . . .	. . . . .	. . . . .	36
48-13706A40 . . . . .Mirage®	. . . . .033036	. . . . .	. . . . .345136	. . . . .	. . . . .	. . . . .	. . . . .	36
48-13706A41 . . . . .Mirage®	. . . . .033036	. . . . .	. . . . .345136	. . . . .	. . . . .	. . . . .	. . . . .	36
48-13706A45 . . . . .Mirage®Plus	. . . . .033036	. . . . .	. . . . .345136	. . . . .	. . . . .	. . . . .	. . . . .	36
48-13706A46 . . . . .Mirage®Plus	. . . . .033036	. . . . .	. . . . .	. . . . .	. . . . .	. . . . .	. . . . .	21, 36
48-13707A41 . . . . .Mirage®(LH)	. . . . .033035	. . . . .	. . . . .	. . . . .	. . . . .	. . . . .	. . . . .	21, 36
48-13707A45 . . . . .Mirage®Plus(LH)	. . . . .033035	. . . . .	. . . . .	. . . . .	. . . . .	. . . . .	. . . . .	21, 36
48-13707A55 . . . . .Mirage®Plus(LH)	. . . . .033057	. . . . .	. . . . .	. . . . .	. . . . .	. . . . .	. . . . .	36
48-137706A55 . . . . .Mirage®Plus	. . . . .033058	. . . . .	. . . . .	. . . . .	. . . . .	. . . . .	. . . . .	36
48-16312A4 . . . . .QSS™	. . . . .033002	. . . . .033072	. . . . .345131	. . . . .	. . . . .993002	. . . . .102	. . . . .	21, 34, 35
48-16312A45 . . . . .Vengeance	. . . . .033002	. . . . .033072	. . . . .345131	. . . . .	. . . . .993002	. . . . .102	. . . . .	21, 34, 35
48-16312A46 . . . . .Vengeance	. . . . .033002	. . . . .033072	. . . . .345131	. . . . .	. . . . .993002	. . . . .102	. . . . .	21, 34, 35
48-16312A5 . . . . .QSS™	. . . . .033002	. . . . .033072	. . . . .345131	. . . . .	. . . . .993002	. . . . .102	. . . . .	21, 34, 35
48-16314A4 . . . . .QSS™	. . . . .033003	. . . . .033074	. . . . .345132	. . . . .	. . . . .993003	. . . . .102	. . . . .	21, 34, 35
48-16314A45 . . . . .Vengeance	. . . . .033003	. . . . .033074	. . . . .345132	. . . . .	. . . . .993003	. . . . .102	. . . . .	21, 34, 35
48-16314A46 . . . . .Vengeance	. . . . .033003	. . . . .033074	. . . . .345132	. . . . .	. . . . .993003	. . . . .102	. . . . .	21, 34, 35
48-16314A5 . . . . .QSS™	. . . . .033003	. . . . .033074	. . . . .345132	. . . . .	. . . . .993003	. . . . .102	. . . . .	21, 34, 35
48-16315A4 . . . . .QSS™ (LH)	. . . . .033075	. . . . .	. . . . .345162	. . . . .	. . . . .993013	. . . . .102	. . . . .	21, 34, 35
48-16315A45 . . . . .Vengeance(LH)	. . . . .033075	. . . . .	. . . . .345162	. . . . .	. . . . .993013	. . . . .102	. . . . .	21, 34, 35
48-16315A5 . . . . .QSS™ (LH)	. . . . .033075	. . . . .	. . . . .345162	. . . . .	. . . . .993013	. . . . .102	. . . . .	21, 34, 35
48-16316A4 . . . . .QSS™	. . . . .033004	. . . . .033076	. . . . .345133	. . . . .	. . . . .993004	. . . . .102	. . . . .	21, 34, 35
48-16316A45 . . . . .Vengeance	. . . . .033004	. . . . .033076	. . . . .345133	. . . . .	. . . . .993004	. . . . .102	. . . . .	21, 34, 35
48-16316A46 . . . . .Vengeance	. . . . .033004	. . . . .033076	. . . . .345133	. . . . .	. . . . .993004	. . . . .102	. . . . .	21, 34, 35
48-16316A5 . . . . .QSS™	. . . . .033004	. . . . .033076	. . . . .345133	. . . . .	. . . . .993004	. . . . .102	. . . . .	21, 34, 35
48-16317A4 . . . . .QSS™ (LH)	. . . . .033077	. . . . .	. . . . .345163	. . . . .	. . . . .993014	. . . . .102	. . . . .	21, 34, 35
48-16317A45 . . . . .Vengeance(LH)	. . . . .033077	. . . . .	. . . . .345163	. . . . .	. . . . .993014	. . . . .102	. . . . .	21, 34, 35
48-16317A5 . . . . .QSS™ (LH)	. . . . .033077	. . . . .	. . . . .345163	. . . . .	. . . . .993014	. . . . .102	. . . . .	21, 34, 35
48-16318A4 . . . . .QSS™	. . . . .033005	. . . . .033078	. . . . .345134	. . . . .	. . . . .993005	. . . . .102	. . . . .	21, 34, 35
48-16318A45 . . . . .Vengeance	. . . . .033005	. . . . .033078	. . . . .345134	. . . . .	. . . . .993005	. . . . .102	. . . . .	21, 34, 35
48-16318A46 . . . . .Vengeance	. . . . .033005	. . . . .033078	. . . . .345134	. . . . .	. . . . .993005	. . . . .102	. . . . .	21, 34, 35
48-16318A5 . . . . .QSS™	. . . . .033005	. . . . .033078	. . . . .345134	. . . . .	. . . . .993005	. . . . .102	. . . . .	21, 34, 35
48-16319A4 . . . . .QSS™ (LH)	. . . . .033079	. . . . .	. . . . .345164	. . . . .	. . . . .993015	. . . . .102	. . . . .	21, 34, 35
48-16319A45 . . . . .Vengeance(LH)	. . . . .033079	. . . . .	. . . . .345164	. . . . .	. . . . .993015	. . . . .102	. . . . .	21, 34, 35
48-16319A5 . . . . .QSS™ (LH)	. . . . .033079	. . . . .	. . . . .345164	. . . . .	. . . . .993015	. . . . .102	. . . . .	21, 34, 35
48-16320A4 . . . . .QSS™	. . . . .033006	. . . . .033080	. . . . .345135	. . . . .	. . . . .993006	. . . . .102	. . . . .	21, 34, 35
48-16320A4 . . . . .QSS™	. . . . .033006	. . . . .033080	. . . . .345135	. . . . .	. . . . .993006	. . . . .102	. . . . .	21, 34, 35
48-16320A45 . . . . .QSS™	. . . . .033006	. . . . .033080	. . . . .345135	. . . . .	. . . . .993006	. . . . .102	. . . . .	21, 34, 35
48-16320A45 . . . . .Vengeance	. . . . .033006	. . . . .033080	. . . . .345135	. . . . .	. . . . .993006	. . . . .102	. . . . .	21, 34, 35
48-16320A46 . . . . .Vengeance	. . . . .033006	. . . . .033080	. . . . .345135	. . . . .	. . . . .993006	. . . . .102	. . . . .	21, 34, 35
48-16320A5 . . . . .QSS™	. . . . .033006	. . . . .033080	. . . . .345135	. . . . .	. . . . .993006	. . . . .102	. . . . .	21, 34, 35
48-16320A5 . . . . .QSS™	. . . . .033006	. . . . .033080	. . . . .345135	. . . . .	. . . . .993006	. . . . .102	. . . . .	21, 34, 35
48-16321A4 . . . . .QSS™ (LH)	. . . . .033081	. . . . .	. . . . .345165	. . . . .	. . . . .993016	. . . . .102	. . . . .	21, 34, 35
48-16321A45 . . . . .Vengeance(LH)	. . . . .033081	. . . . .	. . . . .345165	. . . . .	. . . . .993016	. . . . .102	. . . . .	21, 34, 35
48-16321A5 . . . . .QSS™ (LH)	. . . . .033081	. . . . .	. . . . .345165	. . . . .	. . . . .993016	. . . . .102	. . . . .	21, 34, 35
48-16322A4 . . . . .QSS™	. . . . .033082	. . . . .	. . . . .345136	. . . . .	. . . . .993007	. . . . .102	. . . . .	21, 34, 35
48-16322A45 . . . . .	. . . . .033085	. . . . .	. . . . .345136	. . . . .	. . . . .993104	. . . . .See Note 3	. . . . .	21, 34, 35
48-16322A46 . . . . .Vengeance	. . . . .033082	. . . . .	. . . . .345136	. . . . .	. . . . .993007	. . . . .102	. . . . .	21, 34, 35
48-16436A40 . . . . .	. . . . .031063	. . . . .	. . . . .	. . . . .	. . . . .	. . . . .	. . . . .	21, 34, 35
48-16436A45 . . . . .Black Max™	. . . . .031063	. . . . .	. . . . .	. . . . .	. . . . .	. . . . .	. . . . .	21, 34, 35
48-16438A40 . . . . .	. . . . .031050	. . . . .033072	. . . . .	. . . . .	. . . . .992002	. . . . .993002	. . . . .102	21, 34, 35







# MICHIGAN WHEEL OEM CROSS REFERENCE

Original Equipment Manufacturer Part & Trade Mark	Standard Hub Propellers				XHS Hub Propellers			Catalog Page #
								
<b>MERCURY, MARINER, MERCUISER (continued)</b>								
48-16438A45 . . . . .Black Max™	. . .031050	. . .033072			. . .992002	. . .993002	. . .102 . . . .	21, 34, 35
48-16440A40 . . . . .	. . .031051	. . .033074			. . .992003	. . .993003	. . .102 . . . .	21, 34, 35
48-16440A45 . . . . .Black Max™	. . .031051	. . .033074			. . .992003	. . .993003	. . .102 . . . .	21, 34, 35
48-16543A40 . . . . .Laser II™ (LH)		. . .033077	. . .345163			. . .993014	. . .102 . . . .	21, 34, 35
48-16543A41 . . . . .Laser II™ (LH)		. . .033077	. . .345163			. . .993014	. . .102 . . . .	21, 34, 35
48-16543A45 . . . . .Laser II™ (LH)		. . .033077	. . .345163			. . .993014	. . .102 . . . .	21, 34, 35
48-16544A40 . . . . .Laser II™		. . .033076	. . .345133			. . .993004	. . .102 . . . .	21, 34, 35
48-16544A41 . . . . .Laser II™		. . .033076	. . .345133			. . .993004	. . .102 . . . .	21, 34, 35
48-16544A45 . . . . .Laser II™		. . .033076	. . .345133			. . .993004	. . .102 . . . .	21, 34, 35
48-16544A46 . . . . .Laser II™		. . .033076	. . .345133			. . .993004	. . .102 . . . .	21, 34, 35
48-16545A40 . . . . .Laser II™ (LH)		. . .033079	. . .345164			. . .993005	. . .102 . . . .	21, 34, 35
48-16545A41 . . . . .Laser II™ (LH)		. . .033079	. . .345164			. . .993005	. . .102 . . . .	21, 34, 35
48-16545A45 . . . . .Laser II™ (LH)		. . .033079	. . .345164			. . .993005	. . .102 . . . .	21, 34, 35
48-16546A40 . . . . .Laser II™		. . .033078	. . .345134			. . .993005	. . .102 . . . .	21, 34, 35
48-16546A41 . . . . .Laser II™		. . .033078	. . .345134			. . .993005	. . .102 . . . .	21, 34, 35
48-16546A45 . . . . .Laser II™		. . .033078	. . .345134			. . .993005	. . .102 . . . .	21, 34, 35
48-16547A40 . . . . .Laser II™ (LH)		. . .033081	. . .345165			. . .993016	. . .102 . . . .	21, 34, 35
48-16547A41 . . . . .Laser II™ (LH)		. . .033081	. . .345165			. . .993016	. . .102 . . . .	21, 34, 35
48-16547A45 . . . . .Laser II™ (LH)		. . .033081	. . .345165			. . .993016	. . .102 . . . .	21, 34, 35
48-16548A40 . . . . .Laser II™		. . .033080	. . .345135			. . .993006	. . .102 . . . .	21, 34, 35
48-16548A41 . . . . .Laser II™		. . .033080	. . .345135			. . .993006	. . .102 . . . .	21, 34, 35
48-16548A45 . . . . .Laser II™		. . .033080	. . .345135			. . .993006	. . .102 . . . .	21, 34, 35
48-16549A40 . . . . .Laser II™ (LH)		. . .033083				. . .993017	. . .102 . . . .	21, 34, 35
48-16549A41 . . . . .Laser II™ (LH)		. . .033083				. . .993017	. . .102 . . . .	21, 34, 35
48-16549A45 . . . . .Laser II™ (LH)		. . .033083				. . .993017	. . .102 . . . .	21, 34, 35
48-16550A40 . . . . .Laser II™		. . .033082	. . .345136			. . .993007	. . .102 . . . .	21, 34, 35
48-16550A41 . . . . .Laser II™		. . .033082	. . .345136			. . .993007	. . .102 . . . .	21, 34, 35
48-16550A45 . . . . .Laser II™		. . .033082	. . .345136			. . .993007	. . .102 . . . .	21, 34, 35
48-16986A45 . . . . .Vengeance	. . .033016	. . .033084				. . .993007	. . .102 . . . .	20
48-16986A5 . . . . .QSS™	. . .033016	. . .033084				. . .993007	. . .102 . . . .	20
48-16988A45 . . . . .Vengeance	. . .033017	. . .033085				. . .993104	. See Note 3 . .	20
48-16988A5 . . . . .QSS™	. . .033017	. . .033085				. . .993104	. See Note 3 . .	20
48-16990A40 . . . . .Laser II™	. . .033018	. . .033086	. . .335132			. . .993105	. See Note 3 . .	20
48-16990A45 . . . . .Laser II™	. . .033018	. . .033086	. . .335132			. . .993105	. See Note 3 . .	20
48-16992A40 . . . . .Laser II™	. . .033019	. . .033087	. . .335133			. . .993106	. See Note 3 . .	20
48-16992A45 . . . . .Laser II™	. . .033019	. . .033087	. . .335133			. . .993106	. See Note 3 . .	20
48-17874A12 . . . . .	. . .032050							17
48-19638A40 . . . . .Black Max™	. . .031049							17
48-19640A40 . . . . .Black Max™	. . .031048		. . .305129					17
48-19642A40 . . . . .Black Max™	. . .031047		. . .305130					17
48-22575A2 . . . . .	. . .032077							18
48-30388A1 . . . . .	. . .032093							37
48-30390A1 . . . . .	. . .032092							37
48-30396A1 . . . . .	. . .032089							37
48-30396A3 . . . . .	. . .032089							37
48-30396A4 . . . . .	. . .032089							37
48-31072A4 . . . . .	. . .032092							37
48-31080A1 . . . . .	. . .032093							37
48-31082A1 . . . . .	. . .032092							37
48-31454A3 . . . . .	. . .032094							37
48-31456A3 . . . . .	. . .032093							37
48-31458A3 . . . . .	. . .032092							37
48-32180A1 . . . . .	. . .032087							18, 37
48-32180A4 . . . . .	. . .032087							18, 37
48-32182A1 . . . . .	. . .032087							18, 37
48-32182A4 . . . . .	. . .032087							18, 37
48-32184A1 . . . . .	. . .032086							18, 37
48-32184A4 . . . . .	. . .032086							18, 37







# MICHIGAN WHEEL OEM CROSS REFERENCE

Original Equipment Manufacturer Part & Trade Mark	Standard Hub Propellers				XHS Hub Propellers			Catalog Page #
								
<b>MERCURY, MARINER, MERCUISER (continued)</b>								
48-32186A1	..032086							18, 37
48-32188A1	..032085							18, 37
48-32188A4	..032085							18, 37
48-32190A1	..032085							18, 37
48-32192A1	..032084							18, 37
48-32192A4	..032084							18, 37
48-32264A3	..032092							37
48-32386A3	..032094							37
48-32386A4	..031045							20
48-32388A3	..032093							37
48-32390A3	..032091							37
48-32392A3	..032090							37
48-32392A4	..032091							37
48-32746A3	..032094							37
48-32748A3	..032093							37
48-32750A3	..032093							37
48-33480A1	..032135							17
48-33482A1	..032136							17
48-33772A1	..032084							18, 37
48-33772A4	..032084							18, 37
48-33774A1	..032084							18, 37
48-33774A4	..032084							18, 37
48-35936A3	..032090							37
48-35936A4	..032039							19
48-36008A1	..031039	..033080			..992006	..993006	..102	37
48-36010A1	..031038	..033078			..992005	..993005	..102	37
48-36010A4	..031039	..033080			..992006	..993006	..102	37
48-36012A1	..031037	..033076			..992004	..993004	..102	37
48-36012A4	..031038	..033078			..992005	..993005	..102	37
48-36012A5	..031036	..033074			..992002	..993003	..102	37
48-36014A1	..031036	..033074			..992002	..993003	..102	37
48-36014A4	..031037	..033076			..992004	..993004	..102	37
48-36016A4	..031036	..033074			..992002	..993003	..102	37
48-36018A1	..031034							37
48-36020A1	..031034							37
48-36020A4	..031034							37
48-36022A1	..031021							21, 34, 35
48-36022A4	..031021							21, 34, 35
48-37902A4	..032093							37
48-38090A1	..032087							18, 37
48-38094A1	..032086							18, 37
48-38094A4	..032087							18, 37
48-38098A1	..032085							18, 37
48-38098A4	..032086							18, 37
48-42518A10	..032060							17
48-42518A11	..032060							17
48-42520A10	..032058							17
48-42520A11	..032058							17
48-42520A12	..032058							17
48-42522A10	..032052							17
48-42522A11	..032052							17
48-42522A12	..032052							17
48-42738A10	..032141							19
48-42740A10	..032142							19
48-43584A40	..031049							17
48-43586A40	..031048							17
48-43590A40	..031047							17
48-47670A1	..032020							17

# MICHIGAN WHEEL OEM CROSS REFERENCE







Original Equipment Manufacturer Part & Trade Mark	Standard Hub Propellers				XHS Hub Propellers			Catalog Page #
								
<b>MERCURY, MARINER, MERCUISER (continued)</b>								
48-47670A10	.032020							17
48-47670A3	.032020							17
48-47922A1	.032021							17
48-47922A10	.032021							17
48-47926A1	.032019							17
48-47926A10	.032019							17
48-49632A3	.032093							37
48-49632A4	.032094							37
48-49634A1	.031037	.033076			.992004	.993004	.102	37
48-49634A4	.031037	.033076			.992004	.993004	.102	37
48-52008A3	.031045							20
48-52008A4	.031045							20
48-52012A3	.031045							20
48-53892A3	.032094							37
48-53896A3	.032093							37
48-53896A4	.031043	.033086			.992105	.993105	.See Note 3	20
48-53900A3	.032092							37
48-54723A1	.032114							38
48-54724A1	.032113							38
48-54725A1	.032116							38
48-54726A1	.032115							38
48-54727A1	.032118							38
48-54727A4	.032118							38
48-56234A1	.032099							18
48-56234A4	.032099							18
48-56236A1	.032099							18
48-56236A4	.032099							18
48-56254A1	.032099							18
48-56254A4	.032099							18
48-57262A1	.032117							54
48-57263A1	.032118							54
48-58422A1	.031036	.033074			.992003	.993003	.102	37
48-58422A4	.031037	.033076			.992004	.993004	.102	37
48-58424A4	.031038	.033078			.992005	.993005	.102	37
48-58426A1	.031038	.033078			.992005	.993005	.102	37
48-58426A4	.031039	.033080			.992006	.993006	.102	37
48-58826A3	.032090							37
48-58826A4	.032091							37
48-61812A1	.032045	.033093						19
48-61812A4	.032045	.033093						19
48-61814A1	.032044	.033094						19
48-61814A4	.032044	.033094						19
48-61816A1	.032043	.033095						19
48-61816A4	.032043	.033095						19
48-61818A1	.032042	.033095						19
48-61818A4	.032042	.033095						19
48-61820A1	.032041	.033096						19
48-61820A4	.032041	.033096						19
48-61822A1	.032040	.033097						19
48-61822A4	.032040	.033097						19
48-61824A1	.032039							19
48-62274A1	.032045	.033093						19
48-62274A4	.032045	.033093						19
48-63303A1	.032114							38
48-63304A1	.032113							38
48-63305A1	.032116							38
48-63306A1	.032115							38
48-63456A1	.032099							18

# MICHIGAN WHEEL OEM CROSS REFERENCE







Original Equipment Manufacturer Part & Trade Mark	Standard Hub Propellers				XHS Hub Propellers			Catalog Page #
								
<b>MERCURY, MARINER, MERCUISER (continued)</b>								
48-63456A4	.032099							18
48-63494A1	.032014							39,40
48-63494A10	.032014							39,40
48-63538A1	.032039							19
48-63540A1	.032040	.033097						19
48-63542A1	.032041	.033096						19
48-63542A4	.032041	.033096						19
48-63544A1	.032042	.033095						19
48-63544A4	.032042	.033095						19
48-63546A4	.032043	.033095						19
48-64724A1	.031020							19
48-64724A4	.031020							19
48-65022A1	.032092							37
48-65024A1	.032093							37
48-65480A1	.031039	.033080			.992006	.993006	.102	37
48-65588A1	.032093							37
48-65588A4	.032093							37
48-65736A1	.031045							20
48-65736A4	.031045							20
48-65748A1	.032092							37
48-65992A1	.031038	.033078			.992005	.993005	.102	37
48-65992A4	.031038	.033078			.992005	.993005	.102	37
48-66432A1	.031036	.033074			.992003	.993003	.102	37
48-66432A4	.031037	.033076			.992004	.993004	.102	37
48-66450A4	.031036	.033074			.992003	.993003	.102	37
48-67280A1	.032094							37
48-67874A4	.031039	.033080			.992006	.993006	.102	37
48-68556A4	Cleaver™ .033052							36
48-68557A4	Cleaver™ .033053							36
48-68558A4	Cleaver™ .033054							36
48-69260A1	.032115							54
48-69262A1	.032117							54
48-72764A4	QSS™ .033017	.033085				.993104	.See Note 3	20
48-72764A5	QSS™ .033017	.033085				.993104	.See Note 3	20
48-73132A4	.031015	.033088						19
48-73132A40	Black Max™ .031015	.033088						19
48-73134A4	.031016	.033089			.992405		.114	19
48-73134A40	Black Max™ .031016	.033089			.992405		.114	19
48-73136A4	.031017	.033090	.395129		.992406		.114	19
48-73136A40	Black Max™ .031017	.033090	.395129		.992406		.114	19
48-73138A4	.031018	.033091			.992407		.114	19
48-73138A40	Black Max™ .031018	.033091			.992407		.114	19
48-73140A4	.031019	.033092	.395130		.992408		.114	19
48-73140A40	Black Max™ .031019	.033092	.395130		.992408		.114	19
48-73142A40					.992409		.114	19
48-73144A4	.031020							19
48-73144A40	Black Max™ .031020							19
48-73500A4	.031021							21, 34, 35
48-73502A4	.031022							21, 34, 35
48-73504A4	.031023	.033072			.992002	.993002	.102	21, 34, 35
48-73506A4	.031024	.033074			.992003	.993003	.102	21, 34, 35
48-73508A4	.031025	.033076			.992004	.993004	.102	21, 34, 35
48-73510A4	.031026	.033078			.992005	.993005	.102	21, 34, 35
48-73512A4	.031027	.033080			.992006	.993006	.102	21, 34, 35
48-73980A4	QSS™ .033004	.033076				.993004	.102	21, 34, 35
48-73980A5	QSS™ .033004	.033076				.993004	.102	21, 34, 35
48-73982A4	QSS™ .033005	.033078				.993005	.102	21, 34, 35
48-73982A5	QSS™ .033005	.033078				.993005	.102	21, 34, 35









# MICHIGAN WHEEL OEM CROSS REFERENCE

Original Equipment Manufacturer Part & Trade Mark	Standard Hub Propellers				XHS Hub Propellers			Catalog Page #
								
<b>MERCURY, MARINER, MERCUISER (continued)</b>								
48-74266A4 . . . . . QSS™	. . .033004	. . .033076				. . .993004	. . .102 . . . .	21, 34, 35
48-74268A4 . . . . . QSS™	. . .033005	. . .033078				. . .993005	. . .102 . . . .	21, 34, 35
48-74598A4 . . . . . Cleaver™	. . .033052							36
48-74599A4 . . . . . Cleaver™	. . .033053							36
48-74600A4 . . . . . Cleaver™	. . .033054							36
48-74601A4 . . . . . Cleaver™	. . .033055							36
48-74603A4 . . . . . Mirage®	. . .033057							36
48-74604A4 . . . . . Mirage®	. . .033058							36
48-74872A4 . . . . .	. . .031036	. . .033074			. . .992003	. . .993003	. . .102 . . . .	37
48-74874A4 . . . . .	. . .031037	. . .033076			. . .992004	. . .993004	. . .102 . . . .	37
48-74876A4 . . . . .	. . .031038	. . .033078			. . .992005	. . .993005	. . .102 . . . .	37
48-74886A4 . . . . .	. . .031037	. . .033076			. . .992004	. . .993004	. . .102 . . . .	37
48-74888A4 . . . . .	. . .031038	. . .033078			. . .992005	. . .993005	. . .102 . . . .	37
48-75058A4 . . . . . QSS™	. . .033006	. . .033080				. . .993006	. . .102 . . . .	21, 34, 35
48-75160A4 . . . . .	. . .031027	. . .033080			. . .992006	. . .993006	. . .102 . . . .	21, 34, 35
48-75724A4 . . . . . QSS™	. . .033006	. . .033080				. . .993006	. . .102 . . . .	21, 34, 35
48-75724A5 . . . . . QSS™	. . .033006	. . .033080				. . .993006	. . .102 . . . .	21, 34, 35
48-75760A4 . . . . .	. . .031023	. . .033072			. . .992002	. . .993002	. . .102 . . . .	21, 34, 35
48-76230A4 . . . . . QSS™	. . .033028	. . .033091						19
48-76230A5 . . . . . Vengeance	. . .033028	. . .033091						19
48-76232A4 . . . . . QSS™		. . .033092	. . .395130					19
48-76232A5 . . . . . Vengeance		. . .033092	. . .395130					19
48-77338A33 . . . . . Black Max™	. . .031054							20
48-77338A4 . . . . .	. . .031054							20
48-77338A40 . . . . .	. . .031054							20
48-77338A45 . . . . . Black Max™	. . .031054							20
48-77340A4 . . . . .	. . .031055							20
48-77340A40 . . . . .	. . .031055							20
48-77340A45 . . . . . Black Max™	. . .031055							20
48-77342A4 . . . . .	. . .031041	. . .033084	. . .335130		. . .992103	. . .993103	. See Note 3 . .	20
48-77342A40 . . . . .	. . .031041	. . .033084	. . .335130		. . .992103	. . .993103	. See Note 3 . .	20
48-77342A45 . . . . . Black Max™	. . .031041		. . .335130		. . .992103	. . .993103	. See Note 3 . .	20
48-77344A4 . . . . .	. . .031042	. . .033085	. . .335131		. . .992104	. . .993104	. See Note 3 . .	20
48-77344A40 . . . . .	. . .031042	. . .033085	. . .335131		. . .992104	. . .993104	. See Note 3 . .	20
48-77344A45 . . . . . Black Max™	. . .031042	. . .033085	. . .335131		. . .992104	. . .993104	. See Note 3 . .	20
48-77346A4 . . . . .	. . .031043	. . .033086	. . .335132		. . .992105	. . .993105	. See Note 3 . .	20
48-77346A40 . . . . .	. . .031043	. . .033086	. . .335132		. . .992105	. . .993105	. See Note 3 . .	20
48-77346A45 . . . . . Black Max™	. . .031043	. . .033086	. . .335132		. . .992105	. . .993105	. See Note 3 . .	20
48-77348A4 . . . . .	. . .031044	. . .033087	. . .335133		. . .992106	. . .993106	. See Note 3 . .	20
48-77348A40 . . . . .	. . .031044	. . .033087	. . .335133		. . .992106	. . .993106	. See Note 3 . .	20
48-77348A45 . . . . . Black Max™	. . .031044		. . .335133		. . .992106	. . .993106	. See Note 3 . .	20
48-77350A4 . . . . .	. . .031045							20
48-77350A40 . . . . .	. . .031045							20
48-77350A45 . . . . . Black Max™	. . .031045							20
48-77896A1 . . . . .	. . .032113							38
48-77896A10 . . . . .	. . .032113							38
48-77897A1 . . . . .	. . .032114							38
48-77897A10 . . . . .	. . .032114							38
48-77898A1 . . . . .	. . .032115							38
48-77898A10 . . . . .	. . .032115							38
48-77899A1 . . . . .	. . .032116							38
48-77899A10 . . . . .	. . .032116							38
48-77900A1 . . . . .	. . .032117							38
48-77900A10 . . . . .	. . .032117							38
48-77901A1 . . . . .	. . .032118							38
48-77901A10 . . . . .	. . .032118							21, 34, 35
48-78112A4 . . . . .	. . .031021							21, 34, 35
48-78112A40 . . . . .	. . .031021							21, 34, 35







# MICHIGAN WHEEL OEM CROSS REFERENCE

Original Equipment Manufacturer Part & Trade Mark	Standard Hub Propellers				XHS Hub Propellers			Catalog Page #
								
<b>MERCURY, MARINER, MERCURISER (continued)</b>								
48-78112A45 . . . . .Black Max™	. . .031021							21, 34, 35
48-78114A4 . . . . .	. . .031022							21, 34, 35
48-78114A40 . . . . .	. . .031022							21, 34, 35
48-78114A45 . . . . .Black Max™	. . .031022							21, 34, 35
48-78116A4 . . . . .	. . .031023	. . .033072	. . .345131		. . .992002	. . .993002	. . .102	21, 34, 35
48-78116A40 . . . . .	. . .031023	. . .033072	. . .345131		. . .992002	. . .993002	. . .102	21, 34, 35
48-78116A45 . . . . .Black Max™	. . .031023	. . .033072	. . .345131		. . .992002	. . .993002	. . .102	21, 34, 35
48-78118A4 . . . . .	. . .031024	. . .033074	. . .345132		. . .992003	. . .993003	. . .102	21, 34, 35
48-78118A40 . . . . .	. . .031024	. . .033074	. . .345132		. . .992003	. . .993003	. . .102	21, 34, 35
48-78118A45 . . . . .Black Max™	. . .031024	. . .033074	. . .345132		. . .992003	. . .993003	. . .102	21, 34, 35
48-78120A4 . . . . .	. . .031025	. . .033076	. . .345133		. . .992004	. . .993004	. . .102	21, 34, 35
48-78120A40 . . . . .	. . .031025	. . .033076	. . .345133		. . .992004	. . .993004	. . .102	21, 34, 35
48-78120A45 . . . . .Black Max™	. . .031025	. . .033076	. . .345133		. . .992004	. . .993004	. . .102	21, 34, 35
48-78122A4 . . . . .	. . .031026	. . .033078	. . .345134		. . .992005	. . .993005	. . .102	21, 34, 35
48-78122A40 . . . . .	. . .031026	. . .033078	. . .345134		. . .992005	. . .993005	. . .102	21, 34, 35
48-78122A45 . . . . .Black Max™	. . .031026	. . .033078	. . .345134		. . .992005	. . .993005	. . .102	21, 34, 35
48-78124A4 . . . . .	. . .031027	. . .033080	. . .345135		. . .992006	. . .993006	. . .102	21, 34, 35
48-78124A40 . . . . .	. . .031027	. . .033080	. . .345135		. . .992006	. . .993006	. . .102	21, 34, 35
48-78124A45 . . . . .Black Max™	. . .031027	. . .033080	. . .345135		. . .992006	. . .993006	. . .102	21, 34, 35
48-78126A4 . . . . .	. . .031067	. . .033082	. . .345136		. . .992007	. . .993007	. . .102	21, 34, 35
48-78126A40 . . . . .	. . .031067	. . .033082	. . .345136		. . .992007	. . .993007	. . .102	21, 34, 35
48-78126A45 . . . . .Black Max™	. . .031067	. . .033082	. . .345136		. . .992007	. . .993007	. . .102	21, 34, 35
48-79572A4 . . . . .	. . .031036	. . .033074			. . .992003	. . .993003	. . .102	37
48-79574A4 . . . . .	. . .031037	. . .033076			. . .992004	. . .993004	. . .102	37
48-79576A4 . . . . .	. . .031038	. . .033078			. . .992005	. . .993005	. . .102	37
48-79578A4 . . . . .	. . .031039	. . .033080			. . .992006	. . .993006	. . .102	37
48-79792A4 . . . . .QSS™	. . .033001	. . .033089						19
48-79792A5 . . . . .Vengeance	. . .033001	. . .033089						19
48-79794A4 . . . . .QSS™	. . .033003	. . .033074			. . .993003	. . .102		21, 34, 35
48-79794A5 . . . . .QSS™	. . .033003	. . .033074			. . .993003	. . .102		21, 34, 35
48-79830A4 . . . . .QSS™	. . .033003	. . .033074			. . .993003			21, 34, 35
48-80955M . . . . .	. . .012013							18
48-81645M . . . . .	. . .022002							18
48-81647M . . . . .	. . .022001							18
48-81649M . . . . .	. . .022002							18
48-816702A40 . . . . .Black Max™	. . .031056	. . .033089						19
48-816704A40 . . . . .Black Max™	. . .031057	. . .033090						19
48-816706A40 . . . . .Black Max™	. . .031058	. . .033091						19
48-825864A47 . . . . .Tempest Plus	. . .033034							21
48-825940A47 . . . . .Trophy Plus	. . .033040							21
48-825944A47 . . . . .Trophy Plus	. . .033042							21
48-82767 . . . . .	. . .012102							18
48-82768 . . . . .	. . .012011							18
48-82769 . . . . .	. . .012013							18
48-82770 . . . . .	. . .012010							18
48-828148A12 . . . . .Black Max™	. . .032060							17
48-828150A12 . . . . .Black Max™	. . .032058							17
48-828152A12 . . . . .Black Max™	. . .032056							17
48-828154A12 . . . . .Black Max™	. . .032054							17
48-828156A12 . . . . .Black Max™	. . .032052							17
48-828158A12 . . . . .Black Max™	. . .032050							17
48-82826 . . . . .	. . .022003							18
48-832828A45 . . . . .Black Max™	. . .031064	. . .033074	. . .345132		. . .992003	. . .993003	. . .102	21, 34, 35
48-832830A45 . . . . .Black Max™	. . .031065	. . .033076	. . .345133		. . .992004	. . .993004	. . .102	21, 34, 35
48-832832A45 . . . . .Black Max™	. . .031066	. . .033078	. . .345134		. . .992005	. . .993005	. . .102	21, 34, 35
48-832834A45 . . . . .Black Max™	. . .031068	. . .033080	. . .345135		. . .992006	. . .993006	. . .102	21, 34, 35
48-85632A4 . . . . .	. . .031053				. . .992404		. . .114	19
48-85632A40 . . . . .Black Max™	. . .031053				. . .992404		. . .114	19







# MICHIGAN WHEEL OEM CROSS REFERENCE

Original Equipment Manufacturer Part & Trade Mark	Standard Hub Propellers				XHS Hub Propellers			Catalog Page #
								
<b>MERCURY, MARINER, MERCUISER (continued)</b>								
48-86848A4 .....	..031048	.....	.....	.....	.....	.....	.....	17
48-86962A4 .....	..032136	.....	.....	.....	.....	.....	.....	17
48-878612A40 ..... Trophy Sport	..031016	..033089	.....	.....	.....	.....	.....	19
48-88438A4 ..... QSS™	..033007	..033074	.....	.....	.....	..993003	..102	37
48-88440A4 ..... QSS™	..033008	..033076	.....	.....	.....	..993004	..102	37
48-88442A4 ..... QSS™	..033009	..033078	.....	.....	.....	..993005	..102	37
48-88444A4 ..... QSS™	..033006	..033080	.....	.....	.....	..993006	..102	21, 34, 35
48-89852A4 .....	..031049	.....	.....	.....	.....	.....	.....	17
48-89854A4 .....	..031047	.....	.....	.....	.....	.....	.....	17
48-93272A4 ..... QSS™	..033002	..033072	.....	.....	.....	..993002	..102	21, 34, 35
48-93272A5 ..... QSS™	..033002	..033072	.....	.....	.....	..993002	..102	21, 34, 35
48-96622M .....	..012010	.....	.....	.....	.....	.....	.....	18
48-96623M .....	..012013	.....	.....	.....	.....	.....	.....	18
48-96625M .....	..012011	.....	.....	.....	.....	.....	.....	18
48-96628M .....	..012102	.....	.....	.....	.....	.....	.....	18
QA1912X .....	..031064	.....	..345132	.....	..992003	..993003	..102	21, 34, 35
QA1916X .....	..031065	.....	..345133	.....	..992004	..993004	..102	21, 34, 35
QA1918X .....	..031066	.....	..345134	.....	..992005	..993005	..102	21, 34, 35
QA1920X .....	..031027	.....	..345135	.....	..992006	..993006	..102	21, 34, 35
QA1920X .....	..031068	.....	..345165	.....	..992006	..993006	..102	21, 34, 35
QA2000X .....	..031021	.....	.....	.....	.....	.....	.....	21, 34, 35
QA2002X .....	..031063	.....	.....	.....	.....	.....	.....	21, 34, 35
QA2004X .....	..031022	.....	.....	.....	.....	.....	.....	21, 34, 35
QA2006X .....	..031050	.....	..345131	.....	.....	.....	.....	21, 34, 35
QA2008X .....	..031023	.....	..345131	.....	..992002	..993002	..102	21, 34, 35
QA2010X .....	..031051	.....	..345132	.....	..992003	..993003	..102	21, 34, 35
QA2012X .....	..031024	.....	..345132	.....	..992003	..993003	..102	21, 34, 35
QA2014X .....	..031052	.....	..345133	.....	..992004	..993004	..102	21, 34, 35
QA2016X .....	..031025	.....	..345133	.....	..992004	..993004	..102	21, 34, 35
QA2018X .....	..031026	.....	..345134	.....	..992005	..993005	..102	21, 34, 35
QA2022X .....	..031067	.....	..345136	.....	.....	.....	.....	21, 34, 35
QA2028X .....	..031043	.....	.....	.....	..992105	..993105	.See Note 3 ..	20
QA2030X .....	..031054	.....	.....	.....	.....	.....	.....	20
QA2032X .....	..031055	.....	.....	.....	.....	.....	.....	20
QA2034X .....	..031041	.....	.....	.....	..992103	..993103	.See Note 3 ..	20
QA2036X .....	..031042	.....	.....	.....	..992104	..993104	.See Note 3 ..	20
QA2040X .....	..031044	.....	.....	.....	..992106	..993106	.See Note 3 ..	20
QA2042X .....	..031045	.....	.....	.....	.....	.....	.....	20
QA2060R .....	..032141	.....	.....	.....	.....	.....	.....	19
QA2064R .....	..031015	..033088	.....	.....	.....	.....	.....	19
QA2064R .....	..032044	.....	.....	.....	.....	.....	.....	19
QA2064R .....	..032045	..033093	.....	.....	.....	.....	.....	19
QA2066R .....	..032142	.....	.....	.....	.....	.....	.....	19
QA2070R .....	..031053	..033089	.....	.....	.....	.....	.....	19
QA2072R .....	..031056	..033089	.....	.....	.....	.....	.....	19
QA2074R .....	..031016	..033089	.....	.....	.....	.....	.....	19
QA2076R .....	..031057	..033090	..395129	.....	.....	.....	.....	19
QA2078R .....	..031017	..033090	..395129	.....	.....	.....	.....	19
QA2078R .....	..032042	..033095	..395929	.....	.....	.....	.....	19
QA2078R .....	..032043	..033094	.....	.....	.....	.....	.....	19
QA2080R .....	..031058	..033091	.....	.....	.....	.....	.....	19
QA2082R .....	..031018	..033091	.....	.....	.....	.....	.....	19
QA2082R .....	..032041	..033096	.....	.....	.....	.....	.....	19
QA2084R .....	..031019	..033092	..395130	.....	.....	.....	.....	19
QA2084R .....	..032040	..033097	..395930	.....	.....	.....	.....	19
QA2084R .....	..032039	.....	.....	.....	.....	.....	.....	19
QA2088R .....	..031020	.....	.....	.....	.....	.....	.....	19
QA2102R .....	..031049	.....	.....	.....	.....	.....	.....	17







# MICHIGAN WHEEL OEM CROSS REFERENCE

Original Equipment Manufacturer Part & Trade Mark	Standard Hub Propellers				XHS Hub Propellers			Catalog Page #
								
<b>MERCURY, MARINER, MERCUISER (continued)</b>								
QA2106R .....	.031048		.305129					17
QA2108R .....	.031047		.305130					17
QA2120R .....	.032060							17
QA2122R .....	.032058							17
QA2124R .....	.032056							17
QA2126R .....	.032054							17
QA2128R .....	.032052							17
QA2130R .....	.032050							17
QA2226R .....	.032044							19
QA2230R ..... Black Diamond	.032042	.033095	.395929					19
QA2232R .....	.032041	.033096						19
QA2234R .....	.032040	.033097	.935930					19
QA3150R ..... Black Diamond	.012011							18
QA3152R ..... Black Diamond	.012013							18
QA3178R .....	.012008							2
QA3808R .....	.022002							18
QA3812R .....	.022003							18
QA6000 ..... QA3	.031021							21, 34, 35
QA6004 ..... QA3	.031022							21, 34, 35
QA6010 ..... QA3	.031051							21, 34, 35
QA6012 ..... QA3	.031024	.033074			.992003	.993003	.102	21, 34, 35
QA6016 ..... QA3	.031025	.033076			.992004	.993004	.102	21, 34, 35
QA6018 ..... QA3	.031026	.033078			.992005	.993005	.102	21, 34, 35
QA6020 ..... QA3	.031027	.033080			.992006	.993006	.102	21, 34, 35
QA6030 ..... QA3	.031054							20
QA6032 ..... QA3	.031055							20
QA6034 ..... QA3	.031041	.033084			.992103	.993103	See Note 3	20
QA6036 ..... QA3	.031042	.033085			.992104	.993104	See Note 3	20
QA6038 ..... QA3	.031043	.033086			.992105	.993105	See Note 3	20
QA6040 ..... QA3	.031044							20
QA6042 ..... QA3	.031045							20
QA6060T ..... QA3	.032141							19
QA6064T ..... QA3	.031015							19
QA6070T ..... QA3	.031053							19
QA6074T ..... QA3	.031016	.033089						19
QA6078T ..... QA3	.031017							19
QA6082T ..... QA3	.031018	.033091						19
QA6084T ..... QA3	.031019	.033092						19
QA6102T ..... QA3	.031049							17
QA6106T ..... QA3	.031048							17
QA6128T ..... QA3	.032021							17
QS5006X .....	.033030		.345133		.992004	.993004	.102	21
QS5007X .....	.033029		.345163			.993014	.102	21
QS5008X .....	.033032		.345134		.992005	.993005	.102	21
QS5009X .....	.033031		.345164			.993015	.102	21
QS5010X .....	.033034		.345135		.992006	.993006	.102	21
QS5011X .....	.033033		.345165			.993016	.102	21
QS5050X .....	.033002		.345131		.992002	.993002	.102	21, 34, 35
QS5052X .....	.033003		.345132		.992003	.993003	.102	21, 34, 35
QS5052X .....	.033007		.345132		.992003	.993003	.102	37
QS5053X .....			.345162			.993013	.102	21, 36, 37
QS5054X .....	.033004		.345133		.992004	.993004	.102	21, 34, 35
QS5054X .....	.033008		.345133		.992004	.993004	.102	37
QS5056X .....	.033005		.345134		.992005	.993005	.102	21, 34, 35
QS5056X .....	.033009		.345134		.992005	.993005	.102	37
QS5058X .....	.033006		.345135		.992006	.993006	.102	21, 34, 35
QS5070X .....			.345133		.992004	.993004	.102	21, 34, 35
QS5071X .....			.345163			.993014	.102	21, 34, 35







# MICHIGAN WHEEL OEM CROSS REFERENCE

Original Equipment Manufacturer Part & Trade Mark	Standard Hub Propellers				XHS Hub Propellers			Catalog Page #
								
<b>MERCURY, MARINER, MERCUISER (continued)</b>								
QS5072X			.345134		.992005	.993005	.102	21, 34, 35
QS5073X			.345164			.993015	.102	21, 34, 35
QS5074X			.345135	.345141	.992006	.993006	.102	21, 34, 35
QS5075X			.345165			.993016	.102	21, 34, 35
QS5076X			.345136	.345137		.993007	.102	21, 34, 35
QS5076X				.345139				21
QS5077X						.993017	.102	21, 34, 35
QS5116X	.033016		.335130		.992103	.993103	.102	20
QS5118X	.033017		.335131		.992104	.993104	.102	20
QS5120X	.033018		.335132		.992105	.993105	.102	20
QS5122X	.033019		.335133	.335134	.992106	.993106	.102	20
QS5124X				.335135				20
QS5164R	.033001							19
QS5164R		.033089						19
QS5164R		.033094						19
QS5164R	.113001	.033094						19
QS5166R		.033090	.395129					19
QS5166R		.033095	.395929					19
QS5168R	.033028	.033091	.395130					19
QS5168R		.033091	.395130					19
QS5168R		.033096						19
QS5170R		.033092	.395130					19
QS5170R		.033097	.395930					19
QS5180R			.305129					17
TA1916X	Black Diamond XT	.031065	.033076	.345133	.992004	.993004	.102	21, 34, 35
TA1918X	Black Diamond XT	.031066	.033078	.345134	.992005	.993005	.102	21, 34, 35
TA1920X	Black Diamond XT	.031039	.033080	.345135	.992006	.993006	.102	37
TA2000	Black Diamond	.031021						21, 34, 35
TA2004X	Black Diamond	.031034						37
TA2008	Black Diamond	.031023	.033072		.992002	.993002	.102	21, 34, 35
TA2010	Black Diamond	.031051			.992003	.993003	.102	21, 34, 35
TA2012	Black Diamond	.031024	.033074		.992003	.993003	.102	21, 34, 35
TA2014	Black Diamond	.031052			.992004	.993004	.102	21, 34, 35
TA2016	Black Diamond	.031025	.033076		.992004	.993004	.102	21, 34, 35
TA2018	Black Diamond	.031026	.033078		.992005	.993005	.102	21, 34, 35
TA2020	Black Diamond	.031027	.033080		.992006	.993006	.102	21, 34, 35
TA2022X	Black Diamond	.031067	.033082		.992007	.993007	.102	21, 34, 35
TA2030X	Black Diamond	.032089						37
TA2032X	Black Diamond	.032091						37
TA2034	Black Diamond	.031041	.033084		.992103	.993103	.See Note 3	20
TA2036	Black Diamond	.031042	.033085		.992104	.993104	.See Note 3	20
TA2038	Black Diamond	.031043	.033086		.992105	.993105	.See Note 3	20
TA2040	Black Diamond	.031044	.033087		.992106	.993106	.See Note 3	20
TA2048	Black Diamond	.031041	.033084		.992103	.993103	.See Note 3	20
TA2050	Black Diamond	.031042	.033085		.992104	.993104	.See Note 3	20
TA2052	Black Diamond	.031043	.033086		.992105	.993105	.See Note 3	20
TA2054	Black Diamond	.031044			.992106	.993106	.See Note 3	20
TA2060T	Black Diamond	.032141						19
TA2064T	Black Diamond	.031015	.033088					19
TA2066T	Black Diamond	.032142						19
TA2070T	Black Diamond	.031053						19
TA2072T	Black Diamond	.031056	.033089					19
TA2074T	Black Diamond	.031016	.033089					19
TA2076T	Black Diamond	.031057	.033090					19
TA2078T	Black Diamond	.031017	.033090					19
TA2080T	Black Diamond	.031058	.033091					19
TA2082T	Black Diamond	.031018	.033091					19
TA2084T	Black Diamond	.031019	.033092					19







# MICHIGAN WHEEL OEM CROSS REFERENCE

Original Equipment Manufacturer Part & Trade Mark	Standard Hub Propellers				XHS Hub Propellers			Catalog Page #
								
<b>MERCURY, MARINER, MERCURISER (continued)</b>								
TA2088T . . . . . Black Diamond	. . .031022							21, 34, 35
TA2102T . . . . . Black Diamond	. . .032060							17
TA2106T . . . . . Black Diamond	. . .031048							17
TA2122T . . . . . Black Diamond	. . .032058							17
TA2126T . . . . . Black Diamond	. . .032054							17
TA2128T . . . . . Black Diamond	. . .032052							17
TA2202 . . . . . Black Diamond	. . .031044				. . .992106	. . .993106	. See Note 3 . .	20
TA2204 . . . . . Black Diamond	. . .031043	. . .033086			. . .992105	. . .993105	. See Note 3 . .	20
TA2206 . . . . . Black Diamond	. . .031042	. . .033085			. . .992104	. . .993104	. See Note 3 . .	20
TA2208 . . . . . Black Diamond	. . .031041	. . .033084			. . .992103	. . .993103	. See Note 3 . .	20
TA3150T . . . . . Black Diamond	. . .012011							18
TA3152T . . . . . Black Diamond	. . .012013							18
TA3808T . . . . . Black Diamond	. . .022002							18
TS1006 . . . . . Thunderbolt	. . .033030							21, 36
TS1007 . . . . . Thunderbolt	. . .033029							21, 36
TS1008 . . . . . Thunderbolt	. . .033032							21, 36
TS1009 . . . . . Thunderbolt	. . .033031							21, 36
TS1010 . . . . . Thunderbolt	. . .033034							21, 36
TS1011 . . . . . Thunderbolt	. . .033033							21, 36
TS1052 . . . . . Silverado	. . .033003	. . .033074				. . .993003	. . .102 . . . .	21, 34, 35
TS1053 . . . . . Silverado		. . .033075				. . .993013	. . .102 . . . .	21, 34, 35
TS1054 . . . . . Silverado	. . .033004	. . .033076				. . .993004	. . .102 . . . .	21, 34, 35
TS1055 . . . . . Silverado		. . .033077				. . .993014	. . .102 . . . .	21, 34, 35
TS1056 . . . . . Silverado	. . .033005	. . .033078				. . .993005	. . .102 . . . .	21, 34, 35
TS1057 . . . . . Silverado		. . .033079				. . .993015	. . .102 . . . .	21, 34, 35
TS1070 . . . . . Lightspeed		. . .033076				. . .993004	. . .102 . . . .	21, 34, 35
TS1071 . . . . . Lightspeed		. . .033077				. . .993014	. . .102 . . . .	21, 34, 35
TS1072 . . . . . Lightspeed		. . .033078				. . .993005	. . .102 . . . .	21, 34, 35
TS1073 . . . . . Lightspeed		. . .033079				. . .993015	. . .102 . . . .	21, 34, 35
TS1074 . . . . . Lightspeed		. . .033080				. . .993006	. . .102 . . . .	21, 34, 35
TS1075 . . . . . Lightspeed		. . .033081				. . .993016	. . .102 . . . .	21, 34, 35
TS1076 . . . . . Lightspeed		. . .033082				. . .993007	. . .102 . . . .	21, 34, 35
TS1077 . . . . . Lightspeed		. . .033083				. . .993017	. . .102 . . . .	21, 34, 35
TS1116 . . . . . Silverado	. . .033016	. . .033084				. . .993103	. See Note 3 . .	20
TS1118 . . . . . Silverado	. . .033017	. . .033085				. . .993104	. See Note 3 . .	20
TS1120 . . . . . Lightspeed		. . .033086				. . .993105	. See Note 3 . .	20
TS1122 . . . . . Lightspeed		. . .033087				. . .993106	. See Note 3 . .	20
TS1164T . . . . . Silverado	. . .033001	. . .033089						19
TS1166T . . . . . Silverado		. . .033090						19
TS1168T . . . . . Silverado	. . .033028	. . .033091						19
<b>SUZUKI</b>								
58100-90420-019 . . . . .	. . .101035		. . .335933		. . .992106		. . .110 . . . .	26
58100-90J00-019 . . . . .	. . .101033		. . .335931		. . .992104		. . .110 . . . .	26
58100-90J10-019 . . . . .	. . .101034		. . .335932		. . .992105		. . .110 . . . .	26
58100-93703-019 . . . . .	. . .062015							25
58100-93723-019 . . . . .	. . .062016							25
58100-93743-019 . . . . .	. . .062017							25
58100-94313-019 . . . . .	. . .032042	. . .033095			. . .992406		. . .115 . . . .	26
58100-94410 . . . . .		. . .033096						26
58100-94411 . . . . .		. . .033096	. . .395930					26
58100-94412 . . . . .		. . .033096						26
58100-94500-019 . . . . .			. . .335530					26
58100-94512-019 . . . . .			. . .335531					26
58100-94522-019 . . . . .			. . .335532					26
58100-94532-019 . . . . .			. . .335533	. . .335534				26
58100-94554 . . . . .	. . .063001	. . .063042	. . .335530			. . .993103	. . .110 . . . .	26
58100-94561 . . . . .	. . .063003	. . .063044	. . .335532			. . .993105	. . .110 . . . .	26

# MICHIGAN WHEEL OEM CROSS REFERENCE







Original Equipment Manufacturer Part & Trade Mark	Standard Hub Propellers				XHS Hub Propellers			Catalog Page #
								
<b>SUZUKI (continued)</b>								
58100-94571		.063045	.335532			.993106	.110	26
58100-94581	.063002	.063043	.335531			.993104	.110	26
58100-95212-019	.032045	.033093			.992403		.115	26
58100-95222-019	.032044				.992404		.115	26
58100-95353-019	.032041	.033096			.992407		.115	26
58100-95363-019	.032040	.033097	.395929		.992408		.115	26
58100-95373-019	.032039				.992409		.115	26
58100-95382-019			.395930					26
58100-95393-019	.032043	.033094			.992405		.115	26
58100-95500-019	.061001	.063042	.335530		.992103	.993103	.110	26
58100-95511-019	.061002	.063043	.335531		.992104	.993104	.110	26
58100-95521-019	.061003	.063044	.335532		.992105	.993105	.110	26
58100-95530-019	.061004	.063045	.335533		.992106	.993106	.110	26
58100-95D00-019					.992506			25
58100-96410-019					.992502		.121	25
58100-96420-019	.062012				.992503		.121	25
58100-96430-019	.062013				.992504		.121	25
58100-96440-019	.062014				.992505		.121	25
58100-96490-019			.305529					25
58200-96400			.305529					25
99105-00100-16P	.063001	.063042	.335530			.993103	.110	26
99105-00100-18P	.063002	.063043	.335531			.993104	.110	26
99105-00100-20P	.063003	.063044	.335532			.993105	.110	26
99105-00100-22P		.063045		.335534		.993106	.110	26
99105-00101-20P	.063003	.063044	.335532			.993105	.110	26
99105-00101-22P		.063045				.993106	.110	26
99105-00101-24P				.335535				26
99105-00200-16P		.063030	.345531			.993002	.104	27
99105-00200-18P		.063032	.345532			.993003	.104	27
99105-00200-20P		.063034	.345533			.993004	.104	27
99105-00200-22P		.063036	.345534	.345541		.993005	.104	27
99105-00200-24P		.063038	.345535	.345537		.993006	.104	27
99105-00200-26P		.063040		.345538		.993007	.104	27
99105-00201-26P		.063040		.345538		.993007	.104	27
99105-00203-23P Thunder™		.063038		.345537		.993006	.104	27
99105-00203-25P Thunder™		.063040		.345538		.993007	.104	27
99105-0020L-16P		.063031				.993012	.104	27
99105-0020L-18P		.063033	.345562			.993013	.104	27
99105-0020L-20P		.063035	.345563			.993014	.104	27
99105-0020L-22P		.063037	.345564			.993015	.104	27
99105-0020L-24P		.063039	.345565			.993016	.104	27
99105-0020L-26P		.063041				.993017	.104	27
99105-00300-24P		.063038				.993006	.104	27
99105-00300-25P		.063040				.993007	.104	27
99105-00500-12P		.033094						26
99105-00500-13P		.033095	.395929					26
99105-00500-14P		.033096						26
99105-00500-15P		.033097	.395930					26
99105-00600-13P			.305529					25
99105-00600-15P			.305530					25
QA2064R	.032044							26
QA2064R	.032045	.033093						26
QA2078R	.032042	.033095	.395929					26
QA2078R	.032043	.033094						26
QA2082R	.032041	.033096						26
QA2084R	.032040	.033097	.395930					26
QA2084R	.032039							26
QA2202H			.335533		.992106	.993106	.110	26

# MICHIGAN WHEEL OEM CROSS REFERENCE







Original Equipment Manufacturer Part & Trade Mark	Standard Hub Propellers				XHS Hub Propellers			Catalog Page #
								
<b>SUZUKI (continued)</b>								
QA2204H			.335532		.992105	.993105	.110	26
QA2206H			.335531		.992104	.993104	.110	26
QA2208H			.335530		.992103	.993103	.110	26
QA2226R	.032044							26
QA2230R	.032042	.033095	.395929					26
QA2232R	.032041	.033096						26
QA2234R	.032040	.033097	.935930					26
QA2248R	.062012							25
QA2252R	.062013							25
QA2254R	.062014		.305529					25
QA2274R	.062017							25
QS5050X			.345531		.992002	.993002	.104	27
QS5052X			.345532		.992003	.993003	.104	27
QS5053X			.345562			.993013	.104	27
QS5070X			.345533		.992004	.993004	.104	27
QS5071X			.345563			.993014	.104	27
QS5072X			.345534		.992005	.993005	.104	27
QS5073X			.345564			.993015	.104	27
QS5074X			.345535	.345541	.992006	.993006	.104	27
QS5075X			.345565			.993016	.104	27
QS5076X			.345536	.345537		.993007	.104	27
QS5077X						.993017	.104	27
QS5164R		.033094						26
QS5164R	.113001	.033094						26
QS5166R		.033095	.395929					26
QS5168R		.033096						26
QS5170R		.033097	.395930					26
QS5216H			.335530		.992103	.993103	.110	26
QS5218H			.335531		.992104	.993104	.110	26
QS5220H			.335532		.992105	.993105	.110	26
QS5222H			.335533	.335534	.992106	.993106	.110	26
QS5224H				.335535				26
TA2204	.061003	.063044	.335532		.992105	.993105	.110	26
TA2206	.061002	.063043	.335531		.992104	.993104	.110	26
TA2208	.061001	.063042	.335530		.992103	.993103	.110	26
TA2230T	.032042	.033095	.395929					26
TA2248T	.062012							25
TA2252T	.062013							25
TA2254T	.062014							25
TA2274T	.062017							25
<b>TOHATSU &amp; NISSAN</b>								
34664-1015M					.992501		.122	23
346-64102-5	.142022							23
34664-1025M					.992502		.122	23
346-64104-5	.142024							23
34664-1055M					.992506		.122	23
346-64106-5	.142020							23
348-64101-0		.143001						23
348-64102-0	.142003	.143003						23
348-64103-0	.142004	.143004						23
348-64104-0		.143002						23
348-64105-0-not available		.143001						23
353-64103-0	.142005	.013080						24
353-64104-0		.013080						24
353-64105-0	.142006	.013081			.992301		.112	24
35364-1050M					.992301		.112	24
353-64106-0		.013082						24









# MICHIGAN WHEEL OEM CROSS REFERENCE

Original Equipment Manufacturer Part & Trade Mark	Standard Hub Propellers				XHS Hub Propellers			Catalog Page #
								
<b>TOHATSU &amp; NISSAN (continued)</b>								
353-64107-0	..142007	..013082			..992302		..112	24
35364-1070M					..992302		..112	24
353-64108-0	..142008	..013082						24
353-64109-0	..142009	..013083			..992303		..112	24
35364-1090M					..992303		..112	24
361-64102-0					..992406		..116	23
361-64103-0					..992407		..116	23
361-64109-0		..143001						23
361-64113-0	..142001	..143001			..992404		..116	23
361-64114-0	..142002	..143001			..992405		..116	23
362-64102-0	..142017							23
362-64105-0	..142015							23
362-64108-0	..142019							23
3B7-64532-0	..142010	..103056	..335930		..992103	..993103	.See Note 4	24
3B7-64536-0	..142011	..103056	..335931		..992103	..993103	.See Note 4	24
3B7-64541-0	..142012	..103057	..335932		..992104	..993104	.See Note 4	24
3B7-64545-0	..142013	..103058	..335933		..992105	..993105	.See Note 4	24
3B7-64549-0		..103059	..335933					24
3C7645140	..142012	..103057	..335932		..992104	..993104	.See Note 4	24
3C7645360	..142011	..103057	..335931		..992104	..993104	.See Note 4	24
3E3-64526-0		..143002						23
3E3-64528-0		..143003						23
3E3-64531-0		..143004						23
3R064-5250M					..992504		..122	23
QA2030X	..142010		..335930		..992103	..993103	.See Note 4	24
QA2032X	..142011		..335931		..992103	..993103	.See Note 4	24
QA2034X	..142012		..335932		..992104	..993104	.See Note 4	24
QA2036X	..142013		..335933		..992105	..993105	.See Note 4	24
QA3084R	..142007	..013082	..325030					24
QA3088R	..142008	..013083	..325031					24
QA3090R	..142009	..013084						24
QS5116X	..103056		..335930		..992103	..993103	..109	24
QS5118X	..103057		..335931		..992104	..993104	..109	24
QS5120X	..103058		..335932		..992105	..993105	..109	24
QS5122X	..103059		..335933	..335934	..992106	..993106	..109	24
<b>VOLVO</b>								
3850299-3	..161001	..163012	..346031		..992002	..993002	..105	47
3850300-9	..161002	..163014	..346032		..992003	..993003	..105	47
3850301-7	..161003	..163016	..346033		..992004	..993004	..105	47
3850302	..161004	..163018	..346034		..992005	..993005	..105	47
3850302-5	..161004	..163018	..346034		..992005	..993005	..105	47
3850303	..Aluminum		..346035					47
3850305	..SST®	..163002	..163012	..346031		..993002	..105	47
3850305-8	..163002	..163012	..346031			..993002	..105	47
3850306	..SST®		..346032					47
3850307	..SST®	..163004	..163014	..346032		..993003	..105	47
3850307-4	..163004	..163014	..346032			..993003	..105	47
3850308	..SST®	..163006	..163016	..346033		..993004	..105	47
3850308-2	..163006	..163016	..346033			..993004	..105	47
3850309	..SST®	..163008	..163018	..346034		..993005	..105	47
3850309-0	..163008	..163018	..346034			..993005	..105	47
3850310	..SST®	..163010	..163020	..346035		..993006	..105	47
3850310-8	..163010	..163020	..346035			..993006	..105	47
3850311	..VIPER™	..163014	..346032			..993003	..105	47
3850312	..VIPER™	..163016	..346033			..993004	..105	47
3850313	..VIPER™	..163018	..346034			..993005	..105	47
3850314	..VIPER™	..163020	..346035			..993006	..105	47







# MICHIGAN WHEEL OEM CROSS REFERENCE

Original Equipment Manufacturer Part & Trade Mark	Standard Hub Propellers				XHS Hub Propellers			Catalog Page #
							XHS™ Kit	
<b>VOLVO (continued)</b>								
3850314-0		163018	346035			993005	105	47
3850315 (LH)		163013				993012	105	47
3850315-7		163013				993012	105	47
3850316 SST® (LH)	163003	163015	346062			993013	105	47
3850316-5	163003	163015	346062			993013	105	47
3850317 SST® (LH)	163005	163017	346063			993014	105	47
3850317-3	163005	163017	346063			993014	105	47
3850318 SST® (LH)	163007	163019	346064			993015	105	47
3850318-1	163007	163019	346064			993015	105	47
3850319 SST® (LH)	163009	163021	346065			993016	105	47
3850319-9	163009	163021	346065			993016	105	47
3850320 VIPER™ (LH)		163015	346062			993013	105	47
3850321 VIPER™ (LH)		163017	346063			993014	105	47
3850322 VIPER™ (LH)		163019	346064			993015	105	47
3850323 VIPER™ (LH)		163021	346065			993016	105	47
3850323-1		163019	346065			993015	105	47
3855142 Raker®		163016	346034			993004	105	47
3855144 Raker®		163018	346035			993005	105	47
3855146 Raker®		163020	346036			993006	105	47
3855148 Raker®		163022				993007	105	47
3855152 Raker® (LH)		163017	346064			993014	105	47
3855154 Raker® (LH)		163019	346065			993015	105	47
3855156 Raker® (LH)		163021				993016	105	47
3855158 Raker® (LH)		163023				993017	105	47
3858026 VIPER™ (RH)		103046				993003	103	47
3858027 VIPER™ (RH)		103048				993004	103	47
3858028 VIPER™ (RH)		103050				993005	103	47
3858029 VIPER™ (LH)		103047				993013	103	47
3858030 VIPER™ (LH)		103049				993014	103	47
3858031 VIPER™ (LH)		103051				993015	103	47
813226	082045							47
813228	082057							47
813316-7	082087-1							46
814611-0	082059-1							46
814611-1	082059-1							46
814612-8	082029-1							46
814615-1	082060-1							46
814616-9	082030-1							46
814626-8	082025-1							46
814627-6	082027-1							46
814628-4	082031-1							46
814629-2	082033							46
814631-8	082026-1							46
814632-6	082028-1							46
814633-4	082032-1							46
814634-2	082034							46
850864-0	082013-1							46
850865-7	082014-1							46
850866-5	082015-1							46
850867-3	082016-1							46
851035-6	082089-1							46
851037-2	082091-1							46
851038-0	082090-1							46
851039-8	082093-1							46
851040-6	082092-1							46
851124-8	082011-1							46
851125-5	082012-1							46
851138-8	082009-1							46







# MICHIGAN WHEEL OEM CROSS REFERENCE

Original Equipment Manufacturer Part & Trade Mark	Standard Hub Propellers				XHS Hub Propellers			Catalog Page #
								
<b>VOLVO (continued)</b>								
851139-6	.082010-1							46
852085-0	.083003							46
852086-8	.083001							46
852087-6	.083005							46
852137-9	.083006							46
852138-7	.083004							46
852155-1	.083002							46
854146-8	.082032-1							46
854147-6	.082031-1							46
854148-4	.082030-1							46
854149-2	.082029-1							46
854285-4	.082001-1							46
854286-2	.082002-1							46
854286-4	.082002-1							46
854288-8	.082003-1							46
854289-6	.082004-1							46
854977-6	.082001-1							46
854978-4	.082003-1							46
854979-2	.082009-1							46
854982-6	.082011-1							46
854983-4	.082013-1							46
854984-2	.082015-1							46
854986-7	.082089-1							46
854987-5	.082091-1							46
854988-3	.082093-1							46
854993-3	.082004-1							46
854997-4	.082012-1							46
854998-2	.082014-1							46
854999-0	.082016-1							46
872001-3	.082090-1							46
872002-1	.082092-1							46
QA3008X	.161001	.335530			.992002	.993002	.105	47
QA3012X	.161002	.335531			.992003	.993003	.105	47
QA3016X	.161003	.335532			.992004	.993004	.105	47
QA3018X	.161004	.335533			.992005	.993005	.105	47
QA3503R	.082027-1							46
QA3504R	.082032-1							46
QA3505R	.082031-1							46
QA3506R	.082034							46
QA3507R	.082033							46
QA3514R	.082030-1							46
QA3515R	.082029-1							46
QA3534R	.082004-1							46
QA3536R	.082010-1							46
QA3537R	.082009-1							46
QA3542R	.082012-1							46
QA3543R	.082011-1							46
QA3544R	.082014-1							46
QA3545R	.082013-1							46
QS5050X	.163002	.346031			.992002	.993002	.105	47
QS5052X	.163004	.346032			.992003	.993003	.105	47
QS5053X	.163003	.346062				.993013	.105	47
QS5054X	.163006	.346033			.992004	.993004	.105	47
QS5055X	.163005	.346063				.993014	.105	47
QS5056X	.163008	.346034			.992005	.993005	.105	47
QS5057X	.163007	.346064				.993015	.105	47
QS5058X	.163010	.346035			.992006	.993006	.105	47
QS5059X	.163009					.993016	.105	47







# MICHIGAN WHEEL OEM CROSS REFERENCE

Original Equipment Manufacturer Part & Trade Mark	Standard Hub Propellers				XHS Hub Propellers			Catalog Page #
								
<b>VOLVO (continued)</b>								
QS5070X .....			.346033		.992004	.993004	.105	47
QS5071X .....			.346063			.993014	.105	47
QS5072X .....			.346034		.992005	.993005	.105	47
QS5073X .....			.346064			.993015	.105	47
QS5074X .....			.346035		.992006	.993006	.105	47
QS5075X .....			.346065			.993016	.105	47
QS5076X .....			.346032			.993007	.105	47
QS5076X .....			.346036					47
QS5077X .....						.993017	.105	47
TS5050X .....Silverado	.163002	.163012	.345031			.993002	.105	47
TS5052X .....Silverado	.163004	.163014	.345032			.993003	.105	47
TS5054X .....Silverado	.163006	.163016	.345033			.993004	.105	47
TS5056X .....Silverado	.163008	.163018	.345034			.993005	.105	47
TS5058X .....Silverado	.163010	.163020	.345035			.993006	.105	47
<b>YAMAHA</b>								
61A-45972-00-98 .....		.103050				.993005	.103	48
61A-45974-00-98 .....		.103048				.993004	.103	48
61A-45978-00-98 .....		.103046				.993003	.103	48
61B-45972-00-98 (LH) .....		.103051				.993015	.103	48
61B-45974-00-98 (LH) .....		.103049				.993014	.103	48
61B-45978-00-98 (LH) .....		.103047				.993013	.103	48
62A-45970-10-00 .....		.103058		.335934		.993105	.See Note 1	30
62A-45970-10-00 PRO HP .....		.103059				.993106	.See Note 1	30
62A-45972-10-00 .....		.103059		.335935		.993106	.See Note 1	30
62A-45974-10-00 PRO HP .....		.103058				.993105	.See Note 1	30
650-45943-01-36 .....	.012102							28
651-45947-00-36 .....	.012011							28
653-45941-01-36 .....	.012013							28
663-45943-01-36 .....	.032040	.033097						29
663-45943-02-36 .....	.032040	.033097						29
663-45943-02-EL .....	.032040	.033097						29
663-45945-01-36 .....	.032042	.033095						29
663-45945-02-36 .....	.032042	.033095						29
663-45945-02-EL .....	.032042	.033095						29
663-45947-01-36 .....	.032044				.992404		.117	29
663-45947-02-36 .....	.032044				.992404		.117	29
663-45947-02-EL .....	.032044				.992404		.117	29
663-45949-01-36 .....	.032039				.992409		.117	29
663-45949-01-EL .....	.032039				.992409		.117	29
663-45952-02-EL .....	.032043	.033094						29
663-45958-00-36 .....	.032041	.033096						29
663-45958-00-EL .....	.032041	.033096						29
663-45958-01-36 .....	.032041	.033096						29
663-45958-01-EL .....	.032041	.033096						29
663-45970-60-98 .....		.033095	.395929					29
663-45972-60-98 .....	.113001	.033094						29
663-45974-60-98 .....		.033096						29
663-45976-00-98 .....		.033097	.395930					29
663-45978-00-98 .....		.033097						29
664-45941-01-36 .....	.022001				.992501		.123	29
664-45941-01-EL .....	.022001				.992501		.123	29
664-45945-00-36 .....	.022002				.992502		.123	29
664-45945-00-EL .....	.022002				.992502		.123	29
664-45947-01-EL ... ALUMINUM	.022002				.992503		.123	29
664-45949-02-EL .....			.305929		.992505		.123	29
664-45952-00-EL .....			.305930		.992506		.123	29
664-45954-00-EL .....	.022003				.992504		.123	29







# MICHIGAN WHEEL OEM CROSS REFERENCE

Original Equipment Manufacturer Part & Trade Mark	Standard Hub Propellers				XHS Hub Propellers			Catalog Page #
								
<b>YAMAHA (continued)</b>								
664-45970-00-98			.305929					29
66K-45972-B0-00		103054		.345938		.993007	.103	32
683-45943-00-36	102005							28
683-45943-00-EL	102005							28
683-45945-00-36	102004							28
683-45945-00-EL	102004							28
683-45947-00-36	102003							28
683-45947-00-EL	102003							28
683-W4591-02-EL ALUMINUM	102003							50
688-45930-01-98	103026	103057	.335931			.993104	See Note 1	30
688-45930-02-98	103026	103057	.335931			.993104	See Note 1	30
688-45930-60-98	103026	103057	.335931			.993104	See Note 1	30
688-45932-60-98			.335930					30
688-45970-01-98	103027	103058	.335932			.993105	See Note 1	30
688-45970-02-98	103027	103058	.335932			.993105	See Note 1	30
688-45970-03-98	103027	103058	.335932			.993105	See Note 1	30
688-45972-01-98		103059	.335933			.993106	See Note 1	30
688-45972-02-98		103059	.335933			.993106	See Note 1	30
688-45978-60-98	103025	103056	.335931			.993103	See Note 1	30
6E5-45941-00-36	101034	103058	.335932		.992105	.993105	See Note 1	30
6E5-45941-00-EL	101034	103058	.335932		.992105	.993105	See Note 1	30
6E5-45943-00-36	101035	103059	.335933		.992106	.993106	See Note 1	30
6E5-45943-00-EL	101035	103059	.335933		.992106	.993106	See Note 1	30
6E5-45945-00-36	101033	103057	.335931		.992104	.993104	See Note 1	30
6E5-45945-00-EL	101033	103057	.335931		.992104	.993104	See Note 1	30
6E5-45945-01-EL	101033	103057	.335931		.992104	.993104	See Note 1	30
6E5-45947-00-36	101032	103056	.335930		.992103	.993103	See Note 1	30
6E5-45947-00-EL	101032	103056	.335930		.992103	.993103	See Note 1	30
6E5-45949-00-36	101031							30
6E5-45949-00-EL	101031							30
6E5-45954-00-EL	101036							30
6E5-45970-10-00		103048	.345933			.993004	.103	32
6E5-45970-10-98		103048	.345933			.993004	.103	32
6E5-45972-10-00		103052	.345935			.993006	.103	32
6E5-45972-10-98		103052	.345935			.993006	.103	32
6E5-45976-10-00		103050	.345934			.993005	.103	32
6E5-45976-10-98		103050	.345934			.993005	.103	32
6E5-45978-10-00		103054	.345936			.993007	.103	32
6E5-45978-10-98		103054	.345936			.993007	.103	32
6G1-45943-00-36	102002							28
6G1-45943-00-EL	102002							28
6G1-45947-00-EL	102001							28
6G5-45930-00-98		103054	.345936			.993007	.103	32, 48
6G5-45941-00-36	101025	103044	.345931		.992002	.993002	.103	32, 48
6G5-45941-00-98	101025	103044	.345931		.992002	.993002	.103	32, 48
6G5-45941-00-EL	101025	103044	.345931		.992002	.993002	.103	32, 48
6G5-45943-00-36	101029	103050	.345934		.992005	.993005	.103	32, 48
6G5-45943-00-EL	101029	103050	.345934		.992005	.993005	.103	32, 48
6G5-45943-01-98	101029	103050	.345934		.992005	.993005	.103	32, 48
6G5-45945-00-36	101028	103048	.345933		.992004	.993004	.103	32, 48
6G5-45945-00-EL	101028	103048			.992004	.993004	.103	32, 48
6G5-45945-01-98	101028	103048	.345933		.992004	.993004	.103	32, 48
6G5-45945-01-EL	101028	103048			.992004	.993004	.103	32, 48
6G5-45947-01-98	101027	103046	.345932		.992003	.993003	.103	32, 48
6G5-45947-01-EL	101027	103046			.992003	.993003	.103	32, 48
6G5-45949-00-36	101030	103052			.992006	.993006	.103	32, 48
6G5-45949-00-98	101030	103052	.345935		.992006	.993006	.103	32, 48
6G5-45949-00-EL	101030	103052			.992006	.993006	.103	32, 48







# MICHIGAN WHEEL OEM CROSS REFERENCE

Original Equipment Manufacturer Part & Trade Mark	Standard Hub Propellers				XHS Hub Propellers			Catalog Page #
								
<b>YAMAHA (continued)</b>								
6G5-45952-00-98	..101026	..103044			..992003	..993002	..103	32, 48
6G5-45952-00-EL	..101026	..103044			..992003	..993002	..103	32, 48
6G5-45970-00-98		..103044				..993002	..103	32, 48
6G5-45970-01-98		..103044				..993002	..103	32, 48
6G5-45970-02-98		..103044	..345931			..993002	..103	32, 48
6G5-45972-00-98	..103022	..103050				..993005	..103	32, 48
6G5-45972-01-98	..103022	..103050				..993005	..103	32, 48
6G5-45972-02-98	..103022	..103050	..345934			..993005	..103	32, 48
6G5-45972-03-98	..103022	..103050				..993005	..103	32, 48
6G5-45974-00-98	..103020	..103048				..993004	..103	32, 48
6G5-45974-01-98	..103020	..103048				..993004	..103	32, 48
6G5-45974-02-98	..103020	..103048				..993004	..103	32, 48
6G5-45974-03-98	..103020	..103048	..345933			..993004	..103	32, 48
6G5-45976-00-98		..103052				..993006	..103	32, 48
6G5-45976-01-98		..103052	..345935			..993006	..103	32, 48
6G5-45978-00-98	..103018	..103046				..993003	..103	32, 48
6G5-45978-01-98	..103018	..103046				..993003	..103	32, 48
6G5-45978-02-98	..103018	..103046				..993003	..103	32, 48
6G5-45978-03-98	..103018	..103046	..345932			..993003	..103	32, 48
6H5-45943-00-EL	..032040	..033097	..395930		..992408		..117	29
6H5-45945-00-EL	..032042	..033095	..395929		..992406		..117	29
6H5-45952-00-EL	..032043	..033094			..992405		..117	29
6H5-45958-00-EL		..033096			..992407		..117	29
6J9-45970-B0-00		..103054				..993007	..103	32, 48
6J9-45972-B0-00		..103052		..345937		..993006	..103	32, 48
6J9-45976-10-00		..103050		..345941		..993005	..103	32, 48
6K1-45945-00-98	..031025	..033076	..345933		..992004	..993004	..102	31
6K1-45947-00-98	..031024	..033074	..345932		..992003	..993003	..102	31
6K1-45970-00-98 (LH)		..103045				..993012	..103	32, 48
6K1-45970-01-98 (LH)		..103045				..993012	..103	32, 48
6K1-45972-00-00 (LH)		..103051				..993015	..103	32, 48
6K1-45972-00-98 (LH)		..103051				..993015	..103	32, 48
6K1-45972-01-98 (LH)		..103051	..345964			..993015	..103	32, 48
6K1-45974-00-00 (LH)		..103049				..993014	..103	32, 48
6K1-45974-00-98 (LH)		..103049				..993014	..103	32, 48
6K1-45974-01-98 (LH)		..103049				..993014	..103	32, 48
6K1-45974-02-98 (LH)		..103049	..345963			..993014	..103	32, 48
6K1-45976-00-98 (LH)		..103053	..345965			..993016	..103	32, 48
6K1-45976-01-98 (LH)		..103053				..993016	..103	32, 48
6K1-45978-00-00 (LH)		..103047				..993013	..103	32, 48
6K1-45978-00-98 (LH)		..103047				..993013	..103	32, 48
6K1-45978-01-98 (LH)		..103047				..993013	..103	32, 48
6K1-45978-02-98 (LH)		..103047	..345962			..993013	..103	32, 48
6R1-45970-AO-00 (LH)		..103049				..993014	..103	32, 48
6R1-45972-AO-00 (LH)		..103051				..993015	..103	32, 48
6R1-45974-AO-00 (LH)		..103053				..993016	..103	32, 48
6R1-45976-AO-00 (LH)		..103045				..993012	..103	32, 48
6R1-45978-AO-00 (LH)		..103047				..993013	..103	32, 48
6R4-45970-AO-00 ..SALTWATER		..103048				..993004	..103	32, 48
6R4-45972-AO-00 ..SALTWATER		..103050				..993005	..103	32, 48
6R4-45974-AO-00 ..SALTWATER		..103052				..993006	..103	32, 48
6R4-45976-AO-00 ..SALTWATER		..103044				..993002	..103	32, 48
6R4-45978-AO-00 ..SALTWATER		..103046				..993003	..103	32, 48
MAR-GYT3B-03-13 ..STAINLESS		..033095						29
MAR-GYT3B-03-15 ..STAINLESS		..033097						29
MAR-GYT3B-L6-16 (LH)		..103045				..993012	..103	32, 48
MAR-GYT3B-L6-18 (LH)		..103047	..345963			..993013	..103	32, 48
MAR-GYT3B-L6-20 (LH)		..103049	..345964			..993014	..103	32, 48

# MICHIGAN WHEEL OEM CROSS REFERENCE

Original Equipment Manufacturer Part & Trade Mark	Standard Hub Propellers				XHS Hub Propellers			Catalog Page #
								
<b>YAMAHA (continued)</b>								
MAR-GYT3B-L6-22 (LH) .....	.....	103051	.345965	.....	.....	993015	...103 .....	32, 48
MAR-GYT3B-V4-18 .....	.....	103057	.335932	.....	.....	993104	.See Note 1 ..	32, 48
MAR-GYT3B-V4-20 .....	.....	103058	.335933	.....	.....	993105	.See Note 1 ..	32, 48
MAR-GYT3B-V4-22 .....	.....	103059	.....	.....	.....	993106	.See Note 1 ..	32, 48
MAR-GYT3B-V6-16 .....	.....	103044	.345932	.....	.....	993002	...103 .....	32, 48
MAR-GYT3B-V6-18 .....	.....	103046	.345933	.....	.....	993003	...103 .....	32, 48
MAR-GYT3B-V6-20 .....	.....	103048	.345934	.....	.....	993004	...103 .....	32, 48
MAR-GYT3B-V6-22 .....	.....	103050	.345935	.....	.....	993005	...103 .....	32, 48
MAR-GYT3B-V6-24 .....	.....	103052	.345936	.....	.....	993006	...103 .....	32, 48
MAR-GYT3B-V6-25 .....	.....	103054	.....	.....	.....	993007	...103 .....	32, 48
MAR-GYT3B-V6-26 .....	.....	103054	.....	.....	.....	993007	...103 .....	32, 48
MAR-GYT4B-V6-22 .....	.....	.....	.435935	.....	.....	.....	.....	32
MAR-GYT4B-V6-24 .....	.....	.....	.435936	.....	.....	.....	.....	32
MAR-GYT4B-V6-26 .....	.....	.....	.435937	.....	.....	.....	.....	32
MAR-VMAX3-04-18 .....	.....	103057	.335932	.....	.....	993104	.See Note 1 ..	30
MAR-VMAX3-04-20 .....	.....	103058	.335933	.....	.....	993105	.See Note 1 ..	30
MAR-VMAX3-04-22 .....	.....	103059	.....	.....	.....	993106	.See Note 1 ..	30
MAR-VMAX3-06-16 .....	.....	103044	.345932	.....	.....	993002	...103 .....	32, 48
MAR-VMAX3-06-18 .....	.....	103046	.345933	.....	.....	993003	...103 .....	32, 48
MAR-VMAX3-06-20 .....	.....	103048	.345934	.....	.....	993004	...103 .....	32, 48
MAR-VMAX3-06-22 .....	.....	103050	.345935	.435935	.....	993005	...103 .....	32, 48
MAR-VMAX3-06-24 .....	.....	103052	.345936	.435936	.....	993006	...103 .....	32, 48
MAR-VMAX3-06-26 .....	.....	103054	.....	.435937	.....	993007	...103 .....	32, 48
MAR-VMAX3-C6-18 (LH) .....	.....	103047	.345963	.....	.....	993013	...103 .....	32, 48
MAR-VMAX3-C6-20 (LH) .....	.....	103049	.345964	.....	.....	993014	...103 .....	32, 48
MAR-VMAX3-C6-22 (LH) .....	.....	103053	.345965	.....	.....	993016	...103 .....	32, 48
QA1920X .....	.031027	.....	.345135	.....	.992006	993006	...102 .....	31
QA1920X .....	.101030	.....	.345935	.....	.992006	993006	...103 .....	32, 48
QA2000X .....	.031021	.....	.....	.....	.....	.....	.....	31
QA2004X .....	.031022	.....	.....	.....	.....	.....	.....	31
QA2008X .....	.031023	.....	.345131	.....	.992002	993002	...102 .....	31
QA2008X .....	.101025	.....	.345931	.....	.992002	993002	...103 .....	32, 48
QA2010X .....	.101026	.....	.....	.....	.992003	993003	...103 .....	32, 48
QA2012X .....	.031024	.....	.345132	.....	.992003	993003	...102 .....	31
QA2012X .....	.101027	.....	.345932	.....	.992003	993003	...103 .....	32, 48
QA2016X .....	.031025	.....	.345133	.....	.992004	993004	...102 .....	31
QA2016X .....	.101028	.....	.345933	.....	.992004	993004	...103 .....	32, 48
QA2018X .....	.031026	.....	.345134	.....	.992005	993005	...102 .....	31
QA2018X .....	.101029	.....	.345934	.....	.992005	993005	...103 .....	32, 48
QA2022X .....	.031067	.....	.345136	.....	.....	.....	.....	31
QA2028X .....	.031043	.....	.....	.....	.992105	993105	.See Note 3 ..	31
QA2030X .....	.031054	.....	.....	.....	.....	.....	.....	31
QA2030X .....	.101036	.....	.....	.....	.....	.....	.....	30
QA2032X .....	.031055	.....	.....	.....	.....	.....	.....	31
QA2032X .....	.101031	.....	.....	.....	.....	.....	.....	30
QA2034X .....	.101032	.....	.335930	.....	.992103	993103	.See Note 1 ..	30
QA2034X .....	.031041	.....	.....	.....	.992103	993103	.See Note 3 ..	31
QA2036X .....	.101033	.....	.335931	.....	.992104	993104	.See Note 1 ..	30
QA2036X .....	.031042	.....	.....	.....	.992104	993104	.See Note 3 ..	31
QA2038X .....	.101034	.....	.335932	.....	.992105	993105	.See Note 1 ..	30
QA2040X .....	.101035	.....	.335933	.....	.992106	993106	.See Note 1 ..	30
QA2040X .....	.031044	.....	.....	.....	.992106	993106	.See Note 3 ..	31
QA2042X .....	.031045	.....	.....	.....	.....	.....	.....	31
QA2064R .....	.032044	.....	.....	.....	.....	.....	.....	29
QA2064R .....	.032045	.033093	.....	.....	.....	.....	.....	29
QA2078R .....	.032042	.033095	.395929	.....	.....	.....	.....	29
QA2078R .....	.032043	.033094	.....	.....	.....	.....	.....	29
QA2082R .....	.032041	.033096	.....	.....	.....	.....	.....	29

# MICHIGAN WHEEL OEM CROSS REFERENCE

Original Equipment Manufacturer Part & Trade Mark	Standard Hub Propellers				XHS Hub Propellers			Catalog Page #
								
<b>YAMAHA (continued)</b>								
QA2084R .....	..032040	..033097	..395930					29
QA2084R .....	..032039							29
QA2226R .....	..032044							29
QA2230R ..... Black Diamond	..032042	..033095	..395929					29
QA2232R .....	..032041	..033096						29
QA2234R .....	..032040	..033097	..935930					29
QA3150R ..... Black Diamond	..012011							28
QA3152R ..... Black Diamond	..012013							28
QA3178R .....	..012008							28
QA3808R .....	..022002							29
QA3812R .....	..022003							29
QA3902R .....	..102003							28
QA3906R .....	..102004							28
QA3914R .....	..102005							28
QS5050X .....	..033002		..345131		..992002	..993002	..102	31
QS5050X .....			..345931		..992002	..993002	..103	32, 48
QS5052X .....	..033003		..345132		..992003	..993003	..102	31
QS5052X .....			..345932		..992003	..993003	..103	32, 48
QS5053X .....			..345962			..993013	..103	32
QS5054X .....	..033004		..345133		..992004	..993004	..102	31
QS5054X .....			..345933		..992004	..993004	..103	32, 48
QS5056X .....	..033005		..345134		..992005	..993005	..102	31
QS5056X .....			..345934		..992005	..993005	..103	32, 48
QS5058X .....	..033006		..345135		..992006	..993006	..102	31
QS5070X .....			..345933		..992004	..993004	..103	32, 48
QS5071X .....			..345963			..993014	..103	32, 48
QS5072X .....			..345934		..992005	..993005	..103	32, 48
QS5073X .....			..345964			..993015	..103	32, 48
QS5074X .....			..345935	..345941	..992006	..993006	..103	32, 48
QS5075X .....			..345965			..993016	..103	32, 48
QS5076X .....			..345936	..345937		..993007	..103	32, 48
QS5077X .....						..993017	..103	32, 48
QS5116X .....	..033016		..335130		..992103	..993103	..102	31
QS5116X .....	..103056		..335930		..992103	..993103	.See Note 1 ..	30
QS5118X .....	..033017		..335131		..992104	..993104	..102	31
QS5118X .....	..103057		..335931		..992104	..993104	.See Note 1 ..	30
QS5120X .....	..033018		..335132		..992105	..993105	..102	31
QS5120X .....	..103058		..335932		..992105	..993105	.See Note 1 ..	30
QS5122X .....	..033019		..335133		..992106	..993106	..102	31
QS5122X .....	..103059		..335933		..992106	..993106	.See Note 1 ..	30
QS5124X .....				..335935				30
QS5164R .....		..033094						29
QS5164R .....	..113001	..033094						29
QS5166R .....		..033095	..395929					29
QS5168R .....		..033096						29
QS5170R .....		..033097	..395930					29
TA2000X ..... Black Diamond	..031021							31
TA3150T ..... Black Diamond	..012011							28
TA3152T ..... Black Diamond	..012013							28
TA3808T ..... Black Diamond	..022002							29
TA3902T ..... Black Diamond	..102003							28
TA3906T ..... Black Diamond	..102004							28
TA3914T ..... Black Diamond	..102005							28



# MICHIGAN WHEEL OEM CROSS REFERENCE

<b>Note 1</b>	<b>Yamaha</b>	
	T50, 1996 to Present, 15 tooth spline	108
	60-100 HP Including 4-Stroke, 1984 to present, 15 tooth spline	108
	80-140 HP, 1978 thru 1983, 15 tooth spline	102
	115-130 HP, 1984 to present, 15 tooth spline	103

<b>Note 2</b>	<b>Evinrude/Johnson Outboards</b>	
	90-140 Large Gearcase, 1976 thru 1990, 15 tooth spline	101
	90-140 Large Gearcase, 1991 to present, 15 tooth spline	100
	150-300 HP, 1976 thru 1990, 15 tooth spline	101
	150-300 HP, 1991 to present, 15 tooth spline	100
	<b>OMC/Cobra Sterndrives</b>	
	Model 800/Cobra/King Cobra, 1978 thru 1990, 15 tooth spline	101
Model 800/Cobra/King Cobra, 1991 thru 1994, 15 tooth spline	100	



<b>Note 3</b>	<b>Mercury/Mariner</b>	
	40, 50 & 60 HP Bigfoot, 15 tooth spline	102
	70-140 HP Except 135 HP, 1961 to present, 15 tooth spline	102
	XR-4, XR-6, 15 tooth spline	102
	<b>Honda Outboards</b>	
	75-90 HP, thru 1988, 15 tooth spline	102
	75-90 HP, 1999 & Newer, 15 tooth spline	107
	115-130 HP, 1998 & Newer, 15 tooth spline	107
	<b>Force</b>	
	75-150 HP, 1995 & Newer, 15 tooth spline	102
	<b>Yamaha</b>	
80-140 HP, 1978 thru 1983, 15 tooth spline	102	

<b>Note 4</b>	<b>Nissan/Tohatsu</b>	
	90 HP, 1987 & Newer, 15 tooth spline	109
	115 HP, 1992 & Newer, 15 tooth spline	109
	120 HP & 140 HP, 1988 & Newer	109
	<b>Suzuki</b>	
	DF90, DF115, & DF140, 2001 & Newer, 15 tooth spline	110
	<b>Johnson</b>	
	90, 115 & 140 HP (4-Stroke), 2003 & Newer, 15 tooth spline	103
	<b>Yamaha</b>	
	50-100 HP (including 4-Stroke), 1984 & Newer, 15 tooth spline	108
	115-130 HP, 1984 & Newer, 15 tooth spline	103



## XHS™ HUB SYSTEM CROSS REFERENCE TO MERCURY FLO-TORQ® HUB SYSTEM

Mercury Flo-Torq®	XHS™ Hub Kit	Mercury Flo-Torq®	XHS™ Hub Kit
835257A1	.....102	835272A1	.....108
835265A1	.....100	835277A1	.....102
835266A1	.....106	835279A1	.....107
835267A1	.....101	835281A1	.....104
835270A1	.....105	835282A1	.....110
835271A1	.....103	835284A1	.....109



# MI MATCH™ TO XHS™ CROSS REFERENCE

				XHS™ Kit	Series	Engine Application	Diameter	Pitch
011002	992103	993103	...	106	V4	Evinrude/Johnson	13.75	15
011003	992104	993104	...	106	V4	Evinrude/Johnson	13.25	17
011004	992105	993105	...	106	V4	Evinrude/Johnson	13	19
011005	992106	993106	...	106	V4	Evinrude/Johnson	12.75	21
011006	992002	993002	See Note 2	V6	Evinrude/Johnson	15.5	15	
011007	992003	993003	See Note 2	V6	Evinrude/Johnson	15	17	
011008	992004	993004	See Note 2	V6	Evinrude/Johnson	14.5	19	
011009	992005	993005	See Note 2	V6	Evinrude/Johnson	14.25	21	
011010	992006	993006	See Note 2	V6	Evinrude/Johnson	14.25	23	
011024	992104	993104	...	106	V4	Evinrude/Johnson	14	17
011025	992105	993105	...	106	V4	Evinrude/Johnson	14	19
011026	992106	993106	...	106	V4	Evinrude/Johnson	14	21
031001	992103	993103	...	102	V4	Mercury (old)	13	15
031002	992104	993104	...	102	V4	Mercury (old)	13	17
031003	992105	993105	...	102	V4	Mercury (old)	13	19
031004	992106	993106	...	102	V4	Mercury (old)	13	21
031023	992002	993002	...	102	V6	Mercury/Mariner/Yamaha(old)	15.25	15
031024	992003	993003	...	102	V6	Mercury/Mariner/Yamaha(old)	14.5	17
031025	992004	993004	...	102	V6	Mercury/Mariner/Yamaha(old)	14	19
031026	992005	993005	...	102	V6	Mercury/Mariner/Yamaha(old)	13.75	21
031027	992006	993006	...	102	V6	Mercury/Mariner/Yamaha(old)	13.5	23
031035	992002	993002	...	102	I/O	Mercuriser thru 1982	16	15
031036	992003	993003	...	102	I/O	Mercuriser thru 1982	15.75	17
031037	992004	993004	...	102	I/O	Mercuriser thru 1982	15.5	19
031038	992005	993005	...	102	I/O	Mercuriser thru 1982	15.25	21
031039	992006	993006	...	102	I/O	Mercuriser thru 1982	15	23
031041	992103	993103	See Note 3	V4	Mercury/Mariner/Force/Yamaha(old)/Honda	13.75	15	
031042	992104	993104	See Note 3	V4	Mercury/Mariner/Force/Yamaha(old)/Honda	13.25	17	
031043	992105	993105	See Note 3	V4	Mercury/Mariner/Force/Yamaha(old)/Honda	13	19	
031044	992106	993106	See Note 3	V4	Mercury/Mariner/Force/Yamaha(old)/Honda	12.75	21	
031051	992003	993003	...	102	V6	Mercury/Mariner	16	16
031052	992004	993004	...	102	V6	Mercury/Mariner	15.5	18
031064	992003	993003	...	102	V6	Mercury/Mariner	15	17
031065	992004	993004	...	102	V6	Mercury/Mariner	14.5	19
031066	992005	993005	...	102	V6	Mercury/Mariner	14.25	21
031068	992006	993006	...	102	V6	Mercury/Mariner	14	23
032092	992104	993104	...	102	V4	Mercury (old)	13	17
032093	992105	993105	...	102	V4	Mercury (old)	13	19
032094	992106	993106	...	102	V4	Mercury (old)	13	21
061001	992103	993103	...	110	V4	Suzuki	13.75	15
061002	992104	993104	...	110	V4	Suzuki	13.25	17
061003	992105	993105	...	110	V4	Suzuki	13	19
061004	992106	993106	...	110	V4	Suzuki	13	21
101025	992002	993002	...	103	V6 & I/O	Yamaha (current)/Yamaha I/O	15.25	15
101026	992003	993003	...	103	V6 & I/O	Yamaha (current)/Yamaha I/O	14.625	16
101027	992003	993003	...	103	V6 & I/O	Yamaha (current)/Yamaha I/O	14.5	17
101028	992004	993004	...	103	V6 & I/O	Yamaha (current)/Yamaha I/O	14	19
101029	992005	993005	...	103	V6 & I/O	Yamaha (current)/Yamaha I/O	13.75	21
101030	992006	993006	...	103	V6 & I/O	Yamaha (current)/Yamaha I/O	13.5	23
101032	992103	993103	See Note 1	V4	Yamaha (current)	13.5	15	
101033	992104	993104	See Note 1	V4	Yamaha (current)	13.25	17	
101034	992105	993105	See Note 1	V4	Yamaha (current)	13	19	
101035	992106	993106	See Note 1	V4	Yamaha (current)	12.625	21	
142010	992103	993103	...	109	V4	Nissan/Tohatsu	13.5	14.6
142011	992103	993103	...	109	V4	Nissan/Tohatsu	13.5	15.7
142012	992104	993104	...	109	V4	Nissan/Tohatsu	12.9	17.6
142013	992105	993105	...	109	V4	Nissan/Tohatsu	12.6	19.9
161001	992002	993002	...	105	I/O	Volvo SX/OMC Cobra SX	15.5	15
161002	992003	993003	...	105	I/O	Volvo SX/OMC Cobra SX	15	17
161003	992004	993004	...	105	I/O	Volvo SX/OMC Cobra SX	14.5	19
161004	992005	993005	...	105	I/O	Volvo SX/OMC Cobra SX	14.25	21

# RAPTURE™ TO XHS™ CROSS REFERENCE

			XHS™ Kit	Series	Engine Application	Diameter	Pitch
013064	993002	See Note 2	.V6	Evinrude/Johnson/OMC	.14.25	.15	
013065	993012	See Note 2	.V6	Evinrude/Johnson/OMC	.14.25	.15	
013066	993003	See Note 2	.V6	Evinrude/Johnson/OMC	.14.25	.17	
013067	993013	See Note 2	.V6	Evinrude/Johnson/OMC	.14.25	.17	
013068	993004	See Note 2	.V6	Evinrude/Johnson/OMC	.14.25	.19	
013069	993014	See Note 2	.V6	Evinrude/Johnson/OMC	.14.25	.19	
013070	993005	See Note 2	.V6	Evinrude/Johnson/OMC	.14.25	.21	
013071	993015	See Note 2	.V6	Evinrude/Johnson/OMC	.14.25	.21	
013072	993006	See Note 2	.V6	Evinrude/Johnson/OMC	.14.25	.23	
013073	993016	See Note 2	.V6	Evinrude/Johnson/OMC	.14.25	.23	
013074	993007	See Note 2	.V6	Evinrude/Johnson/OMC	.14.25	.25	
013075	993017	See Note 2	.V6	Evinrude/Johnson/OMC	.14.25	.25	
013076	993103	.106	.V4	Evinrude/Johnson/OMC	.13.25	.15	
013077	993104	.106	.V4	Evinrude/Johnson/OMC	.13.25	.17	
013078	993105	.106	.V4	Evinrude/Johnson/OMC	.13.25	.19	
013079	993106	.106	.V4	Evinrude/Johnson/OMC	.13.25	.21	
033072	993002	.102	.V6	Mercury/Mariner/Yamaha	.14.25	.15	
033073	993012	.102	.V6	Mercury/Mariner/Yamaha	.14.25	.15	
033074	993003	.102	.V6	Mercury/Mariner/Yamaha	.14.25	.17	
033075	993013	.102	.V6	Mercury/Mariner/Yamaha	.14.25	.17	
033076	993004	.102	.V6	Mercury/Mariner/Yamaha	.14.25	.19	
033077	993014	.102	.V6	Mercury/Mariner/Yamaha	.14.25	.19	
033078	993005	.102	.V6	Mercury/Mariner/Yamaha	.14.25	.21	
033079	993015	.102	.V6	Mercury/Mariner/Yamaha	.14.25	.21	
033080	993006	.102	.V6	Mercury/Mariner/Yamaha	.14.25	.23	
033081	993016	.102	.V6	Mercury/Mariner/Yamaha	.14.25	.23	
033082	993007	.102	.V6	Mercury/Mariner/Yamaha	.14.25	.25	
033083	993017	.102	.V6	Mercury/Mariner/Yamaha	.14.25	.25	
033084	993103	See Note 3	.V4	Mercury/Mariner/Force/Honda/Yamaha	.13.25	.15	
033085	993104	See Note 3	.V4	Mercury/Mariner/Force/Honda/Yamaha	.13.25	.17	
033086	993105	See Note 3	.V4	Mercury/Mariner/Force/Honda/Yamaha	.13.25	.19	
033087	993106	See Note 3	.V4	Mercury/Mariner/Force/Honda/Yamaha	.13.25	.21	
063030	993002	.104	.V6	Suzuki	.14.25	.15	
063031	993012	.104	.V6	Suzuki	.14.25	.15	
063032	993003	.104	.V6	Suzuki	.14.25	.17	
063033	993013	.104	.V6	Suzuki	.14.25	.17	
063034	993004	.104	.V6	Suzuki	.14.25	.19	
063035	993014	.104	.V6	Suzuki	.14.25	.19	
063036	993005	.104	.V6	Suzuki	.14.25	.21	
063037	993015	.104	.V6	Suzuki	.14.25	.21	
063038	993006	.104	.V6	Suzuki	.14.25	.23	
063039	993016	.104	.V6	Suzuki	.14.25	.23	
063040	993007	.104	.V6	Suzuki	.14.25	.25	
063041	993017	.104	.V6	Suzuki	.14.25	.25	
063042	993103	.110	.V4	Suzuki	.13.25	.15	
063043	993104	.110	.V4	Suzuki	.13.25	.17	
063044	993105	.110	.V4	Suzuki	.13.25	.19	
063045	993106	.110	.V4	Suzuki	.13.25	.21	
103044	993002	.103	.V6 & I/O	Yamaha	.14.25	.15	
103045	993012	.103	.V6 & I/O	Yamaha	.14.25	.15	
103046	993003	.103	.V6 & I/O	Yamaha	.14.25	.17	
103047	993013	.103	.V6 & I/O	Yamaha	.14.25	.17	
103048	993004	.103	.V6 & I/O	Yamaha	.14.25	.19	
103049	993014	.103	.V6 & I/O	Yamaha	.14.25	.19	
103050	993005	.103	.V6 & I/O	Yamaha	.14.25	.21	
103051	993015	.103	.V6 & I/O	Yamaha	.14.25	.21	
103052	993006	.103	.V6 & I/O	Yamaha	.14.25	.23	
103053	993016	.103	.V6 & I/O	Yamaha	.14.25	.23	
103054	993007	.103	.V6 & I/O	Yamaha	.14.25	.25	
103055	993017	.103	.V6 & I/O	Yamaha	.14.25	.25	
103056	993103	See Note 4	.V4	Yamaha/Nissan/Tohatsu/Suzuki	.13.25	.15	

# RAPTURE™ TO XHS™ CROSS REFERENCE

			XHS™ Kit	Series	Engine Application	Diameter	Pitch
103057	993104	See Note 4	.V4	.V4	.Yamaha/Nissan/Tohatsu/Suzuki	.13-1/4	.17
103058	993105	See Note 4	.V4	.V4	.Yamaha/Nissan/Tohatsu/Suzuki	.13-1/4	.19
103059	993106	See Note 4	.V4	.V4	.Yamaha/Nissan/Tohatsu/Suzuki	.13-1/4	.21
163012	993002	.105	.I/O	.I/O	.Volvo SX/SX Cobra/OMC Cobra	.14-1/4	.15
163013	993012	.105	.I/O	.I/O	.Volvo SX/SX Cobra/OMC Cobra	.14-1/4	.15
163014	993003	.105	.I/O	.I/O	.Volvo SX/SX Cobra/OMC Cobra	.14-1/4	.17
163015	993013	.105	.I/O	.I/O	.Volvo SX/SX Cobra/OMC Cobra	.14-1/4	.17
163016	993004	.105	.I/O	.I/O	.Volvo SX/SX Cobra/OMC Cobra	.14-1/4	.19
163017	993014	.105	.I/O	.I/O	.Volvo SX/SX Cobra/OMC Cobra	.14-1/4	.19
163018	993005	.105	.I/O	.I/O	.Volvo SX/SX Cobra/OMC Cobra	.14-1/4	.21
163019	993015	.105	.I/O	.I/O	.Volvo SX/SX Cobra/OMC Cobra	.14-1/4	.21
163020	993006	.105	.I/O	.I/O	.Volvo SX/SX Cobra/OMC Cobra	.14-1/4	.23
163021	993016	.105	.I/O	.I/O	.Volvo SX/SX Cobra/OMC Cobra	.14-1/4	.23
163022	993007	.105	.I/O	.I/O	.Volvo SX/SX Cobra/OMC Cobra	.14-1/4	.25
163023	993017	.105	.I/O	.I/O	.Volvo SX/SX Cobra/OMC Cobra	.14-1/4	.25

<b>Note 1</b>	<b>Yamaha</b>	
	T50, 1996 to Present, 15 tooth spline	108
	60-100 HP Including 4-Stroke, 1984 to present, 15 tooth spline	108
	80-140 HP, 1978 thru 1983, 15 tooth spline	102
	115-130 HP, 1984 to present, 15 tooth spline	103

<b>Note 2</b>	<b>Evinrude/Johnson Outboards</b>	
	90-140 Large Gearcase, 1976 thru 1990, 15 tooth spline	101
	90-140 Large Gearcase, 1991 to present, 15 tooth spline	100
	150-300 HP, 1976 thru 1990, 15 tooth spline	101
	150-300 HP, 1991 to present, 15 tooth spline	100
	<b>OMC/Cobra Sterndrives</b>	
	Model 800/Cobra/King Cobra, 1978 thru 1990, 15 tooth spline	101
	Model 800/Cobra/King Cobra, 1991 thru 1994, 15 tooth spline	100

<b>Note 3</b>	<b>Mercury/Mariner</b>	
	40, 50 & 60 HP Bigfoot, 15 tooth spline	102
	70-140 HP Except 135 HP, 1961 to present, 15 tooth spline	102
	XR-4, XR-6, 15 tooth spline	102
	<b>Honda Outboards</b>	
	75-90 HP, thru 1988, 15 tooth spline	102
	75-90 HP, 1999 & Newer, 15 tooth spline	107
	115-130 HP, 1998 & Newer, 15 tooth spline	107
	<b>Force</b>	
	75-150 HP, 1995 & Newer, 15 tooth spline	102
<b>Yamaha</b>		
	80-140 HP, 1978 thru 1983, 15 tooth spline	102

<b>Note 4</b>	<b>Nissan/Tohatsu</b>	
	90 HP, 1987 & Newer, 15 tooth spline	109
	115 HP, 1992 & Newer, 15 tooth spline	109
	120 HP & 140 HP, 1988 & Newer	109
	<b>Suzuki</b>	
	DF90, DF115, & DF140, 2001 & Newer, 15 tooth spline	110
	<b>Johnson</b>	
	90, 115 & 140 HP (4-Stroke), 2003 & Newer, 15 tooth spline	103
	<b>Yamaha</b>	
	50-100 HP (including 4-Stroke), 1984 & Newer, 15 tooth spline	108
	115-130 HP, 1984 & Newer, 15 tooth spline	103

# OUTBOARD PROPELLERS

## MOTOR APPLICATION GUIDE

---



**2-4 HORSEPOWER**

**Non-Thru Hub Exhaust**

2, 3,3 HP .....2000 & Newer      3-4 HP .....1952-73

Boat Length/Description	MICHIGAN MATCH REPLACEMENT PROPELLERS						Rubber Hub Bushing
	Dia., Rot., Pitch	Bld#	Mat'l	OEM	Part No.		
Std. Replacement	6-1/8 R 4-1/2	3	AL	203919	●012001		

**5 HORSEPOWER**

**Non-Thru Hub Exhaust & Pin Drive**

5 HP .....1965-68

Boat Length/Description	MICHIGAN MATCH REPLACEMENT PROPELLERS						Rubber Hub Bushing
	Dia., Rot., Pitch	Bld#	Mat'l	OEM	Part No.		
12-14' - LL	8 L 7-1/2	3	AL	380104	012004		

**5.5-6 HORSEPOWER**

**Non-Thru Hub Exhaust & Pin Drive**

5.5-6 HP .....1954-65

Boat Length/Description	MICHIGAN MATCH REPLACEMENT PROPELLERS						Rubber Hub Bushing
	Dia., Rot., Pitch	Bld#	Mat'l	OEM	Part No.		
14-16' - LL	7-3/4 R 6-1/2	3	AL		012067		
12-14' - LL	8 R 7-1/4	2	AL	376968	012060		

**4-8 HORSEPOWER**

**Non-Thru Exhaust & Pin Drive**

4 HP .....1980-83      4.5 HP Deluxe .....1986-95      6, 7.5, 8 HP .....1980 & Newer

Boat Length/Description	MICHIGAN MATCH REPLACEMENT PROPELLERS						Rubber Hub Bushing
	Dia., Rot., Pitch	Bld#	Mat'l	OEM	Part No.		
Heavy Boats, HB	8-1/2 R 7	3	AL	391096	012031		
Std. Replacement	8-1/2 R 9	3	AL	390237	012032		

**10 HORSEPOWER**

**Non-Thru Hub Exhaust & 13 Tooth Spline**

10 HP .....1951-57

Boat Length/Description	MICHIGAN MATCH REPLACEMENT PROPELLERS						Rubber Hub Bushing
	Dia., Rot., Pitch	Bld#	Mat'l	OEM	Part No.		
12-14' - AL	9 R 8	3	AL	277595	012006		

**6-15 HORSEPOWER**

**Non-Thru Hub Exhaust & Pin Drive**

6 HP .....1966-79      10 HP .....1958-63      8-15 HP .....2000 & Newer  
 9.5 HP .....1964-73      10, 12, 14 HP \*\*\* .....1982-94

Boat Length/Description	MICHIGAN MATCH REPLACEMENT PROPELLERS						Rubber Hub Bushing
	Dia., Rot., Pitch	Bld#	Mat'l	OEM	Part No.		
14-16' - LL	7-3/4 R 6-1/2	3	AL		012068		
14-16' - AL, SK	8-1/4 R 8	3	AL	387334	012008		
14-16' Runabouts	8-1/4 R 9	3	AL	391534	012101		
12-14' - LL	8 R 7-1/4	3	AL	376968	012005		
12-14' - LL	8-1/4 R 8-1/2	3	AL	377635	012007		

Key to abbreviations: AL: All Loads; CR: Cruisers; HB: Houseboat; HL: Heavy Loads; LL: Light Loads; RB: Runabouts; SB: Sailboat; SK: Skiboat; WB: Workboat; WD: Weedless

- Hub is not included.
- \*\*\* Engines offered in European Market only

**9.9-15 HORSEPOWER**

Thru Hub Exhaust & 13 Tooth Spline

9.9-15 HP .....1974 7 Newer      8, 9.9, 15 HP (4-Stroke) .....1995 & Newer

Boat Length/Description	MICHIGAN MATCH REPLACEMENT PROPELLERS						Part No.			Rubber Hub Bushing
	Dia., Rot., Pitch	Bld#	Mat'l	OEM						
Heavy Bts, SB	10 R 5	3	AL	386669		012113				
14-16' - AL, SK	10 R 7	3	AL	398126		012112				
Std. Replacement	9-1/2 R 10	3	AL	174950		012111				

**15-25 HORSEPOWER**

Non-Thru Hub Exhaust & Pin Drive

15 HP .....1953-56      20 HP .....1969-73      25 HP .....1969-77  
 18 HP .....1957-73

Boat Length/Description	MICHIGAN MATCH REPLACEMENT PROPELLERS						Part No.			Rubber Hub Bushing
	Dia., Rot., Pitch	Bld#	Mat'l	OEM						
CR, HB, SB	9-1/4 R 7	3	AL	388294		012102				
16-18' - HL	9 R 8	3	AL			012014				
Weedless	9 R 10	3	AL	592959		012076				
14-16' - HL	9 R 9	3	AL	379717		012109				
12-14' - HL	9 R 10	3	AL	383629		012011				
12-14' - LL	9-1/4 R 11	3	AL	388088		012013				
12-14' - LL	9-1/4 R 12	3	AL			012010				

**14-28 HORSEPOWER**

Non-Thru Hub Exhaust & 13 Tooth Spline

14 HP .....1989      25 HP § .....1978-91      28 HP .....1986-96  
 25 HP .....1978-84

Boat Length/Description	MICHIGAN MATCH REPLACEMENT PROPELLERS						Part No.			Rubber Hub Bushing
	Dia., Rot., Pitch	Bld#	Mat'l	OEM						
16-18' - HL	9 R 9	3	AL	389068		012021				
16-18' - HL	9 R 9	3	AL			★011030				
15-17' - AL, SK	9 R 10	3	AL	389069		012015				
15-17' - AL, SK	9 R 10	3	AL			★011031				
14-17' - AL, SK	9-1/4 R 11	3	AL	388883		012016				
14-17' - LL	9-1/4 R 12	3	AL	389944		012030				

**20-35 HORSEPOWER**

Thru Hub Exhaust & 14 Tooth Spline

20 HP 2 Cyl. ....1984-97      25 HP 2 & 3 Cyl. ....1984 & Newer      35 HP 2 & 3 Cyl. ....1976 & Newer  
 25 HP (Commercial) ....1993 & Newer      30 HP 2 Cyl. ....1984 & Newer

Boat Length/Description	MICHIGAN MATCH REPLACEMENT PROPELLERS						BALLISTIC™ STAINLESS STEEL PROPS				Rubber Hub Bushing
	Dia., Rot., Pitch	Bld#	Mat'l	OEM	Part No.	Dia. x Pitch	Bld#	RH	LH		
CR, HB	11-1/4 R 7	3	AL	387320	012053						
CR, HB	11-1/4 R 7	3	AL		★011032						
17-20' - AL, SK	11 R 9	3	AL	386317	012054						
17-20' - AL, SK	11 R 9	3	AL		★011033						
16-18' - AL, SK	10-1/2 R 11	3	AL	175190	012055						
15-17' - AL, SK	10 R 13	3	AL	175191	012056	10-1/8 x 13	3	305029			
13-15' - AL, SK	10 R 15	3	AL	390380	012057	10-1/8 x 15	3	305030			

Key to abbreviations: AL: All Loads; CR: Cruisers; HB: Houseboat; HL: Heavy Loads; LL: Light Loads; RB: Runabouts; SB: Sailboat; SK: Skiboat; WB: Workboat; WD: Weedless

★ Indicates a cupped propeller.

**20-35 HORSEPOWER**  
Thru Hub Exhaust & 14 Tooth Spline

20 HP 2 Cyl. ....1984-97      25 HP 2 & 3 Cyl. ....1984 & Newer      35 HP 2 & 3 Cyl. ....1976 & Newer  
25 HP (Commercial) ....1993 & Newer      30 HP 2 Cyl. ....1984 & Newer



Boat Length/Description						
	Dia., Rot., Pitch	Bld#	Mat'l	OEM	Part No.	
17-20' - AL, SK	10-1/4 R 9	3	AL	386317	992501	
17-20' - AL, SK	10-1/4 R 10	3	AL		992502	
16-18' - AL, SK	10-1/4 R 11	3	AL	175190	992503	
16-18' - AL, SK	10-1/8 R 12	3	AL		992504	
15-17' - AL, SK	10-1/8 R 13	3	AL	175191	992505	
13-15' - AL, SK	10-1/8 R 14	3	AL		992506	

Use XHS™ Hub Kit  
**118**

\*NEW\* VORTEX™ - AVAILABLE SPRING OF 2004 SEASON.

**25-40 HORSEPOWER**  
Thru Hub Exhaust & 13 Tooth Spline

25 HP .....1951-55      33 HP .....1965-70      40 HP .....1960-76  
28 HP .....1962-64      35 HP .....1957-59      40 HP § .....1978-85  
30 HP .....1956

Boat Length/Description						
	Dia., Rot., Pitch	Bld#	Mat'l	OEM	Part No.	
CR, HB, SB	10-1/2 R 10	3	AL	376738	012027	
17-19' - AL, SK	10-3/8 R 11-1/2	3	AL	385955	012023	
14-16' - AL, SK	10-3/8 R 12-1/2	3	AL	378580	012022	
14-16' - AL, SK	10-1/2 R 12	3	AL	380637	012024	
14-16' - LL	10-3/8 R 13-1/2	3	AL	378579	012025	
14-16' - LL	10-1/2 R 13	3	AL	384460	012028	
12-14' - LL	10-3/8 R 14	3	AL	378571	012026	

Rubber Hub Bushing

**40-50 HORSEPOWER (4-STROKE)**  
Thru Hub Exhaust & 13 Tooth Spline

40 HP (4-Stroke) .....1999 & Newer      50 HP (4-Stroke) .....1999 & Newer

Boat Length/Description													
	Dia., Rot., Pitch	Bld#	Mat'l	OEM	Part No.	Dia. x Pitch	Bld#	RH	Dia. x Pitch	Bld#	RH	LH	
18-21' - AL	12-1/4 R 10	3	AL		032045	10-1/2 x 10	3	033093					
18-21' - AL	12-1/4 R 10	3	AL		*031072								
17-19' - AL	12 R 11	3	AL		032044								
17-19' - AL	12 R 11	3	AL		*031073								
16-18' - LL	10-5/8 R 12	3	SS		113001	10-1/2 x 12	3	033094					
15-17' - LL	11-3/4 R 12	3	AL		032043								
14-16' - LL	11-1/2 R 13	3	AL		032042	10-1/2 x 13	3	033095	10-1/8 x 13	3	395929		
12-14' - LL	11-1/4 R 14	3	AL		032041	10-1/2 x 14	3	033096					
12-14' - LL	11 R 15	3	AL		032040	10-1/2 x 15	3	033097	10-1/8 x 15	3	395930		
12-14' - LL	10-3/4 R 16	3	AL		032039								

Rubber Hub Bushing



Boat Length/Description						
	Dia., Rot., Pitch	Bld#	Mat'l	OEM	Part No.	
	12 R 8	4	AL		992401	
	12 R 9	4	AL		992402	
18-21' - AL	12 R 10	4	AL	58100-95212-019	992403	
17-19' - AL	10-3/8 R 11	3	AL	58100-95222-019	992404	
16-18' - LL	10-3/8 R 12	3	AL	58100-95393-019	992405	
14-16' - LL	10-3/8 R 13	3	AL	58100-94313-019	992406	
12-14' - LL	10 R 14	3	AL	58100-95353-019	992407	
12-14' - LL	10 R 15	3	AL	58100-95363-019	992408	
12-14' - LL	10 R 16	3	AL	58100-95373-019	992409	

Use XHS™ Hub Kit  
**115**

\*NEW\* VORTEX™ - AVAILABLE SPRING OF 2004 SEASON.

Key to abbreviations: AL: All Loads; CR: Cruisers; HB: Houseboat; HL: Heavy Loads; LL: Light Loads; RB: Runabouts; SB: Sailboat; SK: Skiboat; WB: Workboat; WD: Weedless



\* Indicates a cupped propeller.      § Commercial & Workhorse Applications.





**60-70 HORSEPOWER (4-STROKE)**

Thru Hub Exhaust & 13 Tooth Spline

60, 70 HP (4-Stroke) + .....1998 & Newer



Boat Length/Description											Use XHS™ Hub Kit <b>110</b>
	Dia., Rot., Pitch	Bld#	Mat'l	OEM	Part No.	Dia. x Pitch	Bld#	RH	LH		
16-18' - RB, SK	13-3/4 R 15	3	AL	391198	992103	13-1/4 x 15	3	993103			
15-17' - RB, SK	13-1/4 R 17	3	AL	177131	992104	13-1/4 x 17	3	993104			
14-16' - RB, SK	13 R 19	3	AL	176215	992105	13-1/4 x 19	3	993105			
13-15' - RB, SK	12-3/4 R 21	3	AL	176216	992106	13-1/4 x 21	3	993106			



Boat Length/Description											Rubber Hub Bushing
	Dia., Rot., Pitch	Bld#	Mat'l	OEM	Part No.	Dia. x Pitch	Bld#	RH	LH		
17-19' - AL, SK	13-3/4 R 15	3	AL		*061001	13-5/8 x 15	3	335530			
17-19' - AL, SK	13-3/4 R 15	3	SS		063001						
15-18' - AL, SK	13-1/4 R 17	3	AL		*061002	13-1/2 x 17	3	335531			
14-16' - AL, SK	13 R 19	3	AL		*061003	13-3/8 x 19	3	335532			
14-16' - LL	13 R 21	3	AL		*061004	13-1/8 x 21	3	335533			

**40-75 HORSEPOWER • SMALL GEARCASE**

Non-Thru Hub Exhaust

40 HP 2 Cyl. ....1984 & Newer      55 HP 2 Cyl. ....1976-79      Sprint .....1986-92  
 48 HP .....1987-96      60 HP 2 Cyl. ....1980-85      Formula E .....1986-92  
 50 HP 2 Cyl. ....1975 & Newer      75 HP 3 Cyl. ....1975-85

Boat Length/Description														Rubber Hub Bushing
	Dia., Rot., Pitch	Bld#	Mat'l	OEM	Part No.	Dia. x Pitch	Bld#	RH	Dia. x Pitch	Bld#	RH	LH		
CR, HB	13 R 11	3	AL	386907	012036	11-3/4 x 11	3	013080						
CR, HB	13 R 11	3	AL		*011034									
15-18' - AL, SK	12-1/2 R 13	3	AL	386909	012037	11-3/4 x 13	3	013081						
15-18' - AL, SK	12-1/2 R 13	3	AL		*011035									
15-18' - AL, SK	12-1/2 R 13	3	SS	390849	013024									
14-17' - AL, SK	12-1/4 R 15	3	AL	386786	012038	11-3/4 x 15	3	013082	12-3/8 x 15	3	325030			
14-17' - AL, SK	12-1/4 R 15	3	AL	176421	*011027									
14-17' - AL, SK	12-1/4 R 15	3	SS	390850	013010									
13-15' - LL	11-3/4 R 17	3	AL	386841	012039	11-3/4 x 17	3	013083	12 x 17	3	325031			
13-15' - LL	11-3/4 R 17	3	AL	176422	*011028									
13-15' - LL	11-3/4 R 17	3	SS	390851	013026									
12-14' - LL	11 R 19	3	AL	176423	*011029									
12-14' - LL	11-1/4 R 19	3	SS	390852	013032									
12-14' - LL	11-1/2 R 19	3	AL	386908	012040									

Boat Length/Description											Use XHS™ Hub Kit <b>111</b>
	Dia., Rot., Pitch	Bld#	Mat'l	OEM	Part No.	Dia. x Pitch	Bld#	RH	LH		
	12 R 8	4	AL		992401						
	12 R 9	4	AL		992402						
	12 R 10	4	AL		992403						
15-18' - AL, SK	12 R 13	3	AL	386909	992301						
14-17' - AL, SK	12 R 15	3	AL	386786	992302						
13-15' - LL	12 R 17	3	AL	386841	992303						

\*NEW\* VORTEX™ - AVAILABLE SPRING OF 2004 SEASON.



Key to abbreviations: AL: All Loads; CR: Cruisers; HB: Houseboat; HL: Heavy Loads; LL: Light Loads; RB: Runabouts; SB: Sailboat; SK: Skiboat; WB: Workboat; WD: Weedless

+ Use stopper 57632-87E10, spacer 57633-95501, washer 09160-18018      \* Indicates a cupped propeller.  
 \* If currently using uncupped propeller, use cupped propeller having 2" less pitch. Boats with power trim use same pitch.      ► LIMITED INVENTORY ITEMS.

## 45-75 HORSEPOWER • LARGE GEARCASE

### Thru Hub Exhaust & 13 Tooth Spline

45 HP 2 Cyl. Commercial . . . . .1986 & Newer	50 HP 2 Cyl. Pleasure . . . . .1971-74	65 HP 3 Cyl. Pleasure . . . . .1972-73
50 HP 2 Cyl. Commercial . . . . .1977-79	50 HP 3 Cyl. Pleasure . . . . .1994 & Newer	70 HP 3 Cyl. Pleasure . . . . .1974 & Newer
55 HP 2 Cyl. Commercial . . . . .1980 & Newer	55 HP 3 Cyl. Pleasure . . . . .1968-69	75 HP 3 Cyl. Pleasure . . . . .1975-84
65 HP 3 Cyl. Commercial . . . . .1984 & Newer	60 HP 3 Cyl. Pleasure . . . . .1970-71, 1986 & Newer	

Boat Length/Description											
	Dia., Rot., Pitch	Bld#	Mat'l	OEM	Part No.		Dia. x Pitch	Bld#	RH	LH	
16-18' - RB, SK	13-3/4 R 15	3	AL	391198	<b>992103</b>		13-1/4 x 15	3	<b>993103</b>		
15-17' - RB, SK	13-1/4 R 17	3	AL	391199	<b>992104</b>		13-1/4 x 17	3	<b>993104</b>		
14-16' - RB, SK	13 R 19	3	AL	390896	<b>992105</b>		13-1/4 x 19	3	<b>993105</b>		
13-15' - RB, SK	12-3/4 R 21	3	AL	389788	<b>992106</b>		13-1/4 x 21	3	<b>993106</b>		

**Use XHS™ Hub Kit 106**  
Do NOT use Gearcase Adapter Ring supplied with propeller.

Boat Length/Description											
	Dia., Rot., Pitch	Bld#	Mat'l	OEM	Part No.		Dia. x Pitch	Bld#	RH	LH	
CR, HB	14 R 10	4	AL		<b>012074</b>						
CR, HB	14 R 10	4	AL		<b>*011036</b>						
CR, HB	14 R 11	3	AL	382761	<b>012047</b>						
CR, HB	14 R 11	3	AL		<b>*011038</b>						
CR, HB	14 R 13	3	AL	391668	<b>*011001</b>						
19-22' - AL	14 R 12	4	AL		<b>012075</b>						
19-22' - AL	14 R 12	4	AL		<b>*011037</b>						
17-19' - AL, SK	13-3/4 R 15	3	AL	391198	<b>*011002</b>		13-5/8 x 15	3	<b>335030</b>		
17-19' - AL, SK	13-3/4 R 15	3	SS	389949	<b>013028</b>						
15-18' - AL, SK	13-1/4 R 17	3	AL	391199	<b>*011003</b>		13-1/2 x 17	3	<b>335031</b>		
15-18' - AL, SK	13-3/8 R 17	3	SS	389948	<b>013030</b>						
15-18' - AL, SK	14 R 17	3	AL	176214	<b>*011024</b>						
14-16' - AL, SK	13 R 19	3	AL	390896	<b>*011004</b>		13-3/8 x 19	3	<b>335032</b>		
14-16' - AL, SK	13 R 19	3	SS	389510	<b>013033</b>						
14-16' - AL, SK	14 R 19	3	AL	176215	<b>*011025</b>						
13-15' - AL, SK	12-3/4 R 21	3	AL	389788	<b>*011005</b>		13-1/8 x 21	3	<b>335033</b>		
13-15' - AL, SK	12-3/4 R 21	3	SS	389512	<b>013034</b>						
13-15' - AL, SK	14 R 21	3	AL	176216	<b>*011026</b>						

**Rubber Hub Bushing**

## 60-90 HORSEPOWER

### Non-Thru Hub Exhaust

V-4 HP 60, 65, 75, 80, 85, 90 . . .1960-68      ♦ Small Hub Prop uses special small nut #302001

Boat Length/Description											
	Dia., Rot., Pitch	Bld#	Mat'l	OEM	Part No.						
17-19' - AL, SK	10 R 9-1/4	3	AL	379260	<b>♦012042</b>						
17-19' - AL, SK	10-1/4 R 10	3	AL	378040	<b>012043</b>						
16-17' - AL, SK	10 R 11	3	AL	377978	<b>012044</b>						
14-16' - AL, SK	10 R 12	3	AL	378039	<b>012045</b>						

**Rubber Hub Bushing**

Key to abbreviations: AL: All Loads; CR: Cruisers; HB: Houseboat; HL: Heavy Loads; LL: Light Loads; RB: Runabouts; SB: Sailboat; SK: Skiboat; WB: Workboat; WD: Weedless

♦ Indicates a cupped propeller.      \* If currently using uncupped propeller, use cupped propeller having 2" less pitch. Boats with power trim use same pitch.  
♦ Available from Michigan Wheel Distributors - order part number 302001 (NP74)

## 100 HORSEPOWER

### Non-Thru Hub Exhaust

100 HP .....1966-68

Boat Length/Description	MICHIGAN MATCH PERFORMANCE PROPELLERS						Part No.	Rubber Hub Bushing
	Dia., Rot., Pitch	Bld#	Mat'l	OEM				
20-24' - 1 Engine	14 R 11	3	AL	382676		012089		
20-24' - 1 Engine	14 R 12	3	AL	382017		012090		

## 85-140 HORSEPOWER • V-4 GEARCASE

### Thru Hub Exhaust & 13 Tooth Spline

85 HP .....1969-80, 1991-95      110 HP .....1986-89      125 HP .....1971-72  
 88 HP .....1981-1996      112 HP .....1994-96      135 HP .....1973-76  
 90 HP .....1981 & Newer      115 HP .....1973 & Newer      140 HP .....1977-94  
 100 HP .....1979-80, 1988-93      120 HP .....1986-94

Boat Length/Description	VORTEX <sup>XHS</sup> PERFORMANCE PROPELLERS						RAPTURE <sup>XHS</sup>				Use XHS™ Hub Kit 106 Do NOT use Gearcase Adapter Ring supplied with propeller.
	Dia., Rot., Pitch	Bld#	Mat'l	OEM	Part No.	Dia. x Pitch	Bld#	RH	LH		
19-22' - RB, SK	13-3/4 R 15	3	AL	391198	992103	13-1/4 x 15	3	993103			
18-21' - RB, SK	13-1/4 R 17	3	AL	391199	992104	13-1/4 x 17	3	993104			
17-20' - RB, SK	13 R 19	3	AL	390896	992105	13-1/4 x 19	3	993105			
15-18' - RB, SK	12-3/4 R 21	3	AL	389788	992106	13-1/4 x 21	3	993106			



Boat Length/Description	MICHIGAN MATCH PERFORMANCE PROPELLERS						BALLISTIC <sup>™</sup> STAINLESS STEEL PROPS				Rubber Hub Bushing
	Dia., Rot., Pitch	Bld#	Mat'l	OEM	Part No.	Dia. x Pitch	Bld#	RH	LH		
CR, HB	14 R 10	4	AL		012074						
CR, HB	14 R 10	4	AL		*011036						
CR, HB	14 R 11	3	AL	382761	012047						
CR, HB	14 R 11	3	AL		*011038						
CR, HB	14 R 12	4	AL		012075						
CR, HB	14 R 12	4	AL		*011037						
CR, HB	14 R 13	3	AL	391668	*011001						
20-24' -AL, SK	13-3/4 R 15	3	AL	391198	*011002	13-5/8 x 15	3	335030			
20-24' -AL, SK	13-3/4 R 15	3	SS	389949	013028						
19-22' -AL, SK	13-1/4 R 17	3	AL	391199	*011003	13-1/2 x 17	3	335031			
19-22' -AL, SK	13-3/8 R 17	3	SS	389948	013030						
19-22' -AL, SK	14 R 17	3	AL	176214	*011024						
17-19' -AL, SK	13 R 19	3	AL	390896	*011004	13-3/8 x 19	3	335032			
17-19' -AL, SK	13 R 19	3	SS	389510	013033						
17-19' -AL, SK	14 R 19	3	AL	176215	*011025						
15-18' -AL, SK	12-3/4 R 21	3	AL	389788	*011005	13-1/8 x 21	3	335033			
15-18' -AL, SK	12-3/4 R 21	3	SS	389512	013034						
15-18' -AL, SK	14 R 21	3	AL	176216	*011026						
High Performance						13-1/2 x 22	3	335034 (XL)			
High Performance						13-1/2 x 24	3	335035 (XL)			

Key to abbreviations: AL: All Loads; CR: Cruisers; HB: Houseboat; HL: Heavy Loads; LL: Light Loads; RB: Runabouts; SB: Sailboat; SK: Skiboat; WB: Workboat; WD: Weedless

\* Indicates a cupped propeller.      \* If currently using uncupped propeller, use cupped propeller having 2" less pitch. Boats with power trim use same pitch.

90-140 HORSEPOWER (4-STROKE)



90 HP (4-Stroke) .....2003 & Newer      115 HP (4-Stroke) .....2003 & Newer      140 HP (4-Stroke) .....2003 & Newer



Boat Length/Description											Use XHS™ Hub Kit 103
	Dia., Rot., Pitch	Bld#	Mat'l	OEM	Part No.	Dia. x Pitch	Bld#	RH	LH		
19-22' - RB, SK	13-3/4 R 15	3	AL	5033322	992103	13-1/4 x 15	3	993103			
18-21' - RB, SK	13-1/4 R 17	3	AL	5033323	992104	13-1/4 x 17	3	993104			
17-20' - RB, SK	13 R 19	3	AL	5033324	992105	13-1/4 x 19	3	993105			
15-18' - RB, SK	12-3/4 R 21	3	AL	5033325	992106	13-1/4 x 21	3	993106			

90-300 HORSEPOWER • V-6 GEARCASE (1976-90)

Thru Hub Exhaust & 15 Tooth Spline

100 HP V-4 Commercial .....1984-90      175 HP V-8 .....1977-90      275 HP V-8 .....1986-88  
 120-140 HP V-4 .....1985      185 HP V-6 .....1984-85      300 HP V-8 .....1986-90  
 140 (25") HP V-4 .....1989-90      200 HP V-8 .....1976-90      2.6 Liter V-6 .....1984-85  
 150 HP V-6 .....1978-90      225 HP V-8 .....1986-90      3.6 Liter V-8 .....1986-87  
 155 HP V-8 Commercial .....1978-90      235 HP V-6 .....1978-85

Boat Length/Description											Use XHS™ Hub Kit 101
	Dia., Rot., Pitch	Bld#	Mat'l	OEM	Part No.	Dia. x Pitch	Bld#	RH	LH		
Cruisers	15-1/4 R 15	3	AL	391535	992002	14-1/4 x 15	3	993002	993012		
20-26' - Runabouts	15 R 17	3	AL	177134	992003	14-1/4 x 17	3	993003	993013		
18-22' - Runabouts	14-1/2 R 19	3	AL	177135	992004	14-1/4 x 19	3	993004	993014		
16-20' - Runabouts	14-1/4 R 21	3	AL	177136	992005	14-1/4 x 21	3	993005	993015		
15-19' - Runabouts	14 R 23	3	AL	177137	992006	14-1/4 x 23	3	993006	993016		
						14-1/4 x 25	3	993007	993017		
21-26' - Runabouts	15 R 16	4	AL		992202						
19-22' - Runabouts	14-1/2 R 18	4	AL		992203						
17-20' - Runabouts	14 R 20	4	AL		992204						

Boat Length/Description											Rubber Hub Bushing
	Dia., Rot., Pitch	Bld#	Mat'l	OEM	Part No.	Dia. x Pitch	Bld#	RH	LH		
CR, HB	15-1/2 R 10	3	AL		†011015						
CR, HB	15-1/2 R 13	3	AL	391536	011016						
CR, HB	15-1/2 R 15	3	AL	391535	011006						
CR, HB	15 R 15	3	SS	174926	013052	14-7/8 x 15	3	345031			
CR, HB	15 L 15	3	SS	174927	013051						
20-26' - AL, SK	15 R 17	3	AL	391200	011007	14-3/4 x 17	3	345032	345062		
20-26' - AL, SK	15 R 17	3	SS	391290	013044						
20-26' - AL, SK	15 L 17	3	SS	431930	013043						
18-22' - AL, SK	14-1/2 R 19	3	AL	391201	011008	14-1/2 x 19	3	345033	345063		
18-22' - AL, SK	14-1/2 R 19	3	SS	389924	013046						
18-22' - AL, SK	14-1/2 L 19	3	SS	390821	013045						
17-19' - AL, SK	14-1/4 R 21	3	AL	391202	011009	14-3/8 x 21	3	345034	345064		
17-19' - AL, SK	14-1/4 R 21	3	SS	389923	013048						
17-19' - AL, SK	14-1/4 L 21	3	SS	390822	013047						
15-18' - AL, SK	14-1/4 R 23	3	AL	391203	011010	14-1/4 x 25	3	345035	345065		
15-18' - AL, SK	14-1/4 R 23	3	SS	389019	013050						
High Performance						14-1/2 x 22	3	345041	(XL)		
High Performance						14-1/2 x 24	3	345037	(XL)		
High Performance						14-1/2 x 26	3	345038	(XL)		
<b>High Performance 4 Blade Propellers • 15 Tooth Spline</b>											
50-62 MPH	13-3/4 R 22	4	SS		†**013036	13-3/4 x 23	4	435035	(XL)		
55-67 MPH	13-3/4 R 24	4	SS		†**013038	13-3/4 x 25	4	435036	(XL)		
60-72 MPH						13-3/4 x 27	4	435037	(XL)		

Key to abbreviations: AL: All Loads; CR: Cruisers; HB: Houseboat; HL: Heavy Loads; LL: Light Loads; RB: Runabouts; SB: Sailboat; SK: Skiboat; WB: Workboat; WD: Weedless

† 2-1/2" of skeg must be removed for proper fit. Use thrust washer 33359.



▶ LIMITED INVENTORY ITEMS.

\*\* Forward thrust washer A-9500-111 comes with propeller and replaces the standard OMC thrust washer, except when used on a 1991 or 1992. 1994 through current model engines use OMC thrust washer 12869.



**90-300 HORSEPOWER • V-6 GEARCASE (1991 & NEWER)**

Thru Hub Exhaust & 15 Tooth Spline

90 HP V-4 .....1995 & Newer	150 HP V-6 Commercial .....1993 & Newer	200 HP V-6 .....2000 & Newer
100 HP V-4 Commercial .....1991 & Newer	150 HP V-6 .....1991 & Newer	225 HP V-6 .....1991 & Newer
115 HP V-4 .....1995 & Newer	155 HP V-6 Commercial .....1991 & Newer	250 HP V-8 .....1991 & Newer
130 HP V-4 .....1995 & Newer	175 HP V-6 .....1991 & Newer	300 HP V-8 .....1991-95
140 (25") HP V-4 .....1991-94	200 HP V-6 .....1991 & Newer	

Boat Length/Description										
	Dia., Rot., Pitch	Bld#	Mat'l	OEM	Part No.	Dia. x Pitch	Bld#	RH	LH	
Cruisers	15-1/4 R 15	3	AL	391535	992002	14-1/4 x 15	3	993002	993012	
20-26' - Runabouts	15 R 17	3	AL	177134	992003	14-1/4 x 17	3	993003	993013	
18-22' - Runabouts	14-1/2 R 19	3	AL	177135	992004	14-1/4 x 19	3	993004	993014	
16-20' - Runabouts	14-1/4 R 21	3	AL	177136	992005	14-1/4 x 21	3	993005	993015	
15-19' - Runabouts	14 R 23	3	AL	177137	992006	14-1/4 x 23	3	993006	993016	
						14-1/4 x 25	3	993007	993017	
21-26' - Runabouts	15 R 16	4	AL		992202					
19-22' - Runabouts	14-1/2 R 18	4	AL		992203					
17-20' - Runabouts	14 R 20	4	AL		992204					

Use XHS™  
Hub Kit  
**100**

Boat Length/Description										
	Dia., Rot., Pitch	Bld#	Mat'l	OEM	Part No.	Dia. x Pitch	Bld#	RH	LH	
CR, HB	15-1/2 R 10	3	AL		†011015					
CR, HB	15-1/2 R 13	3	AL	391536	011016					
CR, HB	15-1/2 R 15	3	AL	391535	011006					
CR, HB	15 R 15	3	SS	174926	013052	14-7/8 x 15	3	345031		
CR, HB	15 L 15	3	SS	174927	013051					
20-26' - AL, SK	15 R 17	3	AL	391200	011007	14-3/4 x 17	3	345032	345062	
20-26' - AL, SK	15 R 17	3	SS	391290	013044					
20-26' - AL, SK	15 L 17	3	SS	431930	013043					
18-22' - AL, SK	14-1/2 R 19	3	AL	391201	011008	14-1/2 x 19	3	345033	345063	
18-22' - AL, SK	14-1/2 R 19	3	SS	389924	013046					
18-22' - AL, SK	14-1/2 L 19	3	SS	390821	013045					
17-19' - AL, SK	14-1/4 R 21	3	AL	391202	011009	14-3/8 x 21	3	345034	345064	
17-19' - AL, SK	14-1/4 R 21	3	SS	389923	013048					
17-19' - AL, SK	14-1/4 L 21	3	SS	390822	013047					
15-18' - AL, SK	14-1/4 R 23	3	AL	391203	011010	14-1/4 x 25	3	345035	345065	
15-18' - AL, SK	14-1/4 R 23	3	SS	389019	013050					
High Performance						14-1/2 x 22	3	345041 (XL)		
High Performance						14-1/2 x 24	3	345037 (XL)		
High Performance						14-1/2 x 26	3	345038 (XL)		
<b>High Performance 4 Blade Propellers</b>										
50-62 MPH	13-3/4 R 22	4	SS		†**013036	13-3/4 x 23	4	435035 (XL)		
55-67 MPH	13-3/4 R 24	4	SS		†**013038	13-3/4 x 25	4	435036 (XL)		
60-72 MPH						13-3/4 x 27	4	435037 (XL)		

Rubber  
Hub  
Bushing

Key to abbreviations: AL: All Loads; CR: Cruisers; HB: Houseboat; HL: Heavy Loads; LL: Light Loads; RB: Runabouts; SB: Sailboat; SK: Skiboat; WB: Workboat; WD: Weedless

† 2-1/2" of skeg must be removed for proper fit. Use thrust washer 33359.

▶ LIMITED INVENTORY ITEMS.

\*\* Forward thrust washer A-9500-111 comes with propeller and replaces the standard OMC thrust washer, except when used on a 1991 or 1992. 1994 through current model engines use OMC thrust washer 12869.

**3.5-3.6 HORSEPOWER**

3.5-3.6 HP .....1969-76

Boat Length/Description							Part No.	Rubber Hub Bushing
	Dia., Rot., Pitch	Bld#	Mat'l	OEM				
Std. Replacement	7-1/2 L 4-1/2	2	AL	48-FP19	072017			

**5 HORSEPOWER**

5 HP .....1975-77

Boat Length/Description							Part No.	Rubber Hub Bushing
	Dia., Rot., Pitch	Bld#	Mat'l	OEM				
Std. Replacement	7-1/2 L 5-1/2	2	AL		152014			

**3.5-8 HORSEPOWER**

**Non-Thru Hub Exhaust & 9 Tooth / Pin Drive**

3.5 HP .....1980-84                      5 HP .....1987-98                      4, 4.4, 6, 6.6, 7, 7.5 & 8 hp .....1968-88

Boat Length/Description							Part No.	Rubber Hub Bushing
	Dia., Rot., Pitch	Bld#	Mat'l	OEM				
Std. Replacement	7-1/4 R 5-1/2	3	AL	48-FP488	072123			

**6-10 HORSEPOWER**

**Non-Thru Hub Exhaust & 14 Tooth / Pin Drive**

6-10 HP Sailor .....1976-78                      Sailor 180-250 .....1979-84

Boat Length/Description							Part No.	Rubber Hub Bushing
	Dia., Rot., Pitch	Bld#	Mat'l	OEM				
SB	10-3/8 R 10	3	AL	FP-278	072014			

**9.9-15 HORSEPOWER**

**Non-Thru Hub Exhaust & 18 Tooth Spline**

9.9 HP .....1968-98                      12 HP .....1978-79                      15 HP .....1980-98  
 10 HP .....1974-78                      12.9 HP .....1968-75

Boat Length/Description							Part No.	Rubber Hub Bushing
	Dia., Rot., Pitch	Bld#	Mat'l	OEM				
Std. Replacement	8-1/8 R 8-1/4	3	AL	FP-408	072026			
14-16' - LL	8-1/4 R 6	3	AL	FP-395	072121			
12-14' - LL	8-1/4 R 8-1/4	2	AL	48-FP70	072024			
12-14' - LL	8 R 9	3	AL	FP-472	072122			

Key to abbreviations: AL: All Loads; CR: Cruisers; HB: Houseboat; HL: Heavy Loads; LL: Light Loads; RB: Runabouts; SB: Sailboat; SK: Skiboat; WB: Workboat; WD: Weedless

▶ LIMITED INVENTORY ITEMS.

**25 HORSEPOWER**  
Thru Hub Exhaust & 10 Tooth Spline

25 HP 3 Cyl. ....1995-98

Boat Length/Description	MICHIGAN MATCH REPLACEMENT PROPELLERS						BALLISTIC™ STAINLESS STEEL PROPS				Rubber Hub Bushing
	Dia., Rot., Pitch	Bld#	Mat'l	OEM	Part No.	Dia. x Pitch	Bld#	RH	LH		
15-19'	10-3/8 R 11	3	AL	48-19638A40	031049						
13-17'	10-3/8 R 13	3	AL	48-19640A40	031048	10-1/8 x 13	3	305129			
Up to 14'	10-1/4 R 14-1/2	3	AL	48-19642A40	031047	10-1/8 x 15	3	305130			



Boat Length/Description	VORTEX™ PERFORMANCE PROPELLERS						Use XHS™ Hub Kit 120
	Dia., Rot., Pitch	Bld#	Mat'l	OEM	Part No.		
	10-1/4 R 9	3	AL	48-19636A10	992501		
	10-1/4 R 10	3	AL		992502		
15-17'	10-1/4 R 11	3	AL	48-19638A40	992503		
15-17'	10-1/8 R 12	3	AL	48-19639A40	992504		
13-17'	10-1/8 R 13	3	AL	48-19640A40	992505		
Up to 14'	10-1/8 R 14	3	AL	48-19642A40	992506		

"NEW" VORTEX™ - AVAILABLE SPRING OF 2004 SEASON.

**20-60 HORSEPOWER**  
Non-Thru Hub Exhaust & 14 Tooth / Pin Drive

20-25 HP .....1979-81      40 HP .....1992-94      50 HP .....1982-94  
 30 HP .....1966-82      45 HP .....1966-84      55-60 HP♦♦ .....1966-84  
 35 HP .....1966-91

Boat Length/Description	MICHIGAN MATCH REPLACEMENT PROPELLERS						Rubber Hub Bushing
	Dia., Rot., Pitch	Bld#	Mat'l	OEM	Part No.		
CR, HB, SB	10-3/8 R 10	3	AL	48-819337A40	072014		
17-19' - AL, SK	10-3/8 R 11-1/2	3	AL	48-819336A40	072131		
16-17' - AL, SK	10-3/8 R 12-1/2	3	AL	48-819335A40	072132		
14-16' - AL, SK	10-3/8 R 13-1/2	3	AL	48-819334A4	072133		
14-16' - LL	10-3/8 R 14-1/2	3	AL		072134		

**40-75 HORSEPOWER**  
Thru Hub Exhaust & 13 Tooth Spline

40, 50 HP .....1995-98      70 HP .....1991-95      75 HP .....1996-98

Boat Length/Description	MICHIGAN MATCH REPLACEMENT PROPELLERS						RAPTURE			BALLISTIC™ STAINLESS STEEL PROPS				Rubber Hub Bushing
	Dia., Rot., Pitch	Bld#	Mat'l	OEM	Part No.	Dia. x Pitch	Bld#	Part No.	Dia. x Pitch	Bld#	RH	LH		
19' & Up	12-1/2 R 8	3	AL	48-42738A10	032141									
19' & Up	12-1/2 R 8	3	AL		★031070									
17-19' - AL, SK	11-1/4 R 10	3	AL	48-73132A40	031015	10-1/2 x 10	3	033088						
16-18' - AL, SK	12 R 10-1/2	3	AL	48-42740A10	032142									
16-18' - AL, SK	12 R 10-1/2	3	AL		★031071									
16-18' - AL, SK	10-7/8 R 11	3	AL	48-85632A40	031053									
15-17' - AL, SK	10-3/4 R 12	3	AL	48-816702A40	031056									
15-17' - AL, SK	10-5/8 R 12	3	AL	48-73134A40	031016	10-1/2 x 12	3	033089						
15-17' - AL, SK	10-5/8 R 12	3	SS	48-79792A5	033001									
14-17' - AL, SK	10-1/2 R 13	3	AL	48-816704A40	031057	10-1/2 x 13	3	033090	10-1/8 x 13	3	395129			
14-17' - AL, SK	10-3/8 R 13	3	AL	48-73136A40	031017									
14-16' - LL	10-3/8 R 14	3	AL	48-816706A40	031058									
14-16' - LL	10-1/4 R 14	3	AL	48-73138A40	031018	10-1/2 x 14	3	033091						
14-16' - LL	10-1/4 R 14	3	SS	48-76230A5	033028									
13-15' - LL	10-1/8 R 15	3	AL	48-73140A40	031019	10-1/2 x 15	3	033092	10-1/8 x 15	3	395130			
Up to 15'	10 R 17	3	AL	48-73144A40	031020									

Key to abbreviations: AL: All Loads; CR: Cruisers; HB: Houseboat; HL: Heavy Loads; LL: Light Loads; RB: Runabouts; SB: Sailboat; SK: Skiboat; WB: Workboat; WD: Weedless

★ Indicates cupped Propeller      ♦♦ Two piece lower unit.

## 40-75 HORSEPOWER Thru Hub Exhaust & 13 Tooth Spline

40, 50 HP .....1995-98      70 HP .....1991-95      75 HP .....1996-98



Boat Length/Description							
	Di.,	Rot.,	Pitch	Bld#	Mat'l	OEM	Part No.
19' & Up	12	R	8	4	AL		992401
19' & Up	12	R	9	4	AL		992402
17-19' - AL, SK	12	R	10	4	AL		992403
16-18' - AL, SK	10-3/8	R	11	3	AL	48-85632A40	992404
15-17' - AL, SK	10-3/8	R	12	3	AL	48-73134A40	992405
14-17' - AL, SK	10-3/8	R	13	3	AL	48-73136A40	992406
14-16' - LL	10	R	14	3	AL	48-73138A40	992407
13-15' - LL	10	R	15	3	AL	48-73140A40	992408
13-15' - LL	10	R	16	3	AL	48-73142A40	992409

Use XHS™  
Hub Kit  
**114**

\*"NEW" VORTEX™ - AVAILABLE SPRING OF 2004 SEASON.

## 70-135 HORSEPOWER Non-Thru Hub Exhaust & 18 Tooth Spline & Pin Drive

70-135 HP♦♦ .....1970-79

Boat Length/Description							
	Di.,	Rot.,	Pitch	Bld#	Mat'l	OEM	Part No.
16-17' - AL, SK	13-1/8	R	15	3	AL	FP-389	072032
14-16' - AL, SK	13-1/8	R	17	3	AL	48-FP372	072033
Light Runabouts	13-1/8	R	19	3	AL	FP-383	072034

Rubber  
Hub  
Bushing

## 70-140 HORSEPOWER Non-Thru Hub Exhaust & 15 Tooth Spline

70-140HP♦ .....1977-89

Boat Length/Description							
	Di.,	Rot.,	Pitch	Bld#	Mat'l	OEM	Part No.
17-19' - AL, SK	14	R	13	3	AL	FPS501	072054
16-17' - AL, SK	13-1/8	R	15	3	AL	FPS519	072055
16-17' - AL, SK	13-3/4	R	15	3	SS		073002
14-16' - AL, SK	13-1/4	R	17	3	AL	FPS623	072107
14-16' - AL, SK	13-1/4	R	17	3	SS	FP539	073003
14-16' - LL	13	R	19	3	AL	FPS625	072108
14-16' - LL	13	R	19	3	SS	FP540	073004
High Perf. Racing	13	R	21	3	AL	FPS526	072109

Rubber  
Hub  
Bushing

Key to abbreviations: AL: All Loads; CR: Cruisers; HB: Houseboat; HL: Heavy Loads; LL: Light Loads; RB: Runabouts; SB: Sailboat; SK: Skiboat; WB: Workboat; WD: Weedless

\* One piece lower unit.      ♦♦ Two piece lower unit.      ► LIMITED INVENTORY ITEM

### Single vs. Dual Exhaust (see page 65)

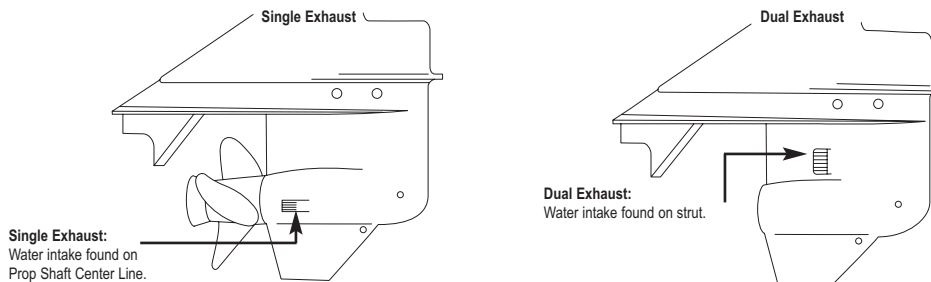



**85-150 HORSEPOWER • SINGLE EXHAUST UNITS**

**Thru Hub Exhaust & 15 Tooth Spline**

85, 125 HP .....1988-89	90 HP L-DRIVE .....1989-91
90, 120 HP .....1990-94	120 HP L-DRIVE .....1989-91
150 HP .....1989-94	150 HP L-DRIVE .....1991

Boat Length/Description	MICHIGAN MATCH REPLACEMENT PROPELLERS						Part No.			Rubber Hub Bushing
	Dia., Rot., Pitch	Bld#	Mat'l	OEM						
17-22' - AL, SK	13-1/2 R 15	3	AL	48-FP669-1		*071035				
17-22' - AL, SK	13-1/2 R 15	3	AL	48-FP692-1		072127				
17-22' - AL, SK	13-3/4 R 15	3	SS	FP699		*073007				
16-20' - AL, SK	13-1/2 R 17	3	AL	48-FP685-1		*071036				
16-20' - AL, SK	13-1/2 R 17	3	AL	48-FP685-1		072128				
16-20' - AL, SK	13-1/4 R 17	3	SS	FP668		*073008				
16-18' - AL, SK	13 R 19	3	AL	48-FP686-1		*071037				
16-18' - AL, SK	13 R 19	3	AL	48-FP686-1		072129				
Up to 16' - AL, SK	12-5/8 R 21	3	AL	48-FP694		*071038				
Up to 16' - AL, SK	13 R 21	3	SS	FP69		*073010				

**75-150 HORSEPOWER • DUAL EXHAUST UNITS**

**Thru Hub Exhaust & 15 Tooth Spline**

75 HP †† .....1999 & Newer	90, 120 HP †† .....1995-98	150 HP † .....1989-94
90 HP L-Drive † .....1990-91	120 HP L-Drive † .....1990-91	150 HP L-Drive † .....1991

Boat Length/Description	MICHIGAN MATCH REPLACEMENT PROPELLERS						BALLISTIC STAINLESS STEEL PROPS				Rubber Hub Bushing
	Dia., Rot., Pitch	Bld#	Mat'l	OEM	Part No.	Dia. x Pitch	Bld#	RH	LH		
25' & Up - AL	14 R 11	3	AL	48-77338A40	031054						
22' & Up - AL	14 R 13	3	AL	48-77340A40	031055						
19-24' - AL, SK	13-3/4 R 15	3	AL	48-77342A40	031041	13-5/8 x 15	3	335130			
19-24' - AL, SK	13-3/4 R 15	3	SS	48-16986A5	033016						
17-20' - AL, SK	13-1/4 R 17	3	AL	48-77344A40	031042	13-1/2 x 17	3	335131			
17-20' - AL, SK	13-1/4 R 17	3	SS	48-16988A5	033017						
16-19' - AL, SK	13 R 19	3	AL	48-77346A40	031043	13-3/8 x 19	3	335132			
16-19' - AL, SK	13 R 19	3	SS	48-16990A40	*033018						
15-18' - AL, SK	12-3/4 R 21	3	AL	48-77348A40	031044	13-1/8 x 21	3	335133			
15-18' - AL, SK	13 R 21	3	SS	48-16992A40	*033019						
Up to 17' - LL	12-1/2 R 23	3	AL	48-77350A40	031045						
High Performance						13-1/2 x 22	3	*335134 (XL)			
High Performance						13-1/2 x 24	3	*335135 (XL)			

**75-150 HORSEPOWER • DUAL EXHAUST UNITS (1995 & NEWER)**

**Thru Hub Exhaust & 15 Tooth Spline**

75-150 HP .....1995 & Newer

Boat Length/Description	VORTEX <sup>XHS</sup> PERFORMANCE PROPELLERS						RAPTURE <sup>XHS</sup>				Use XHS™ Hub Kit 102 Use Gearcase Adapter Ring supplied with propeller.
	Dia., Rot., Pitch	Bld#	Mat'l	OEM	Part No.	Dia. x Pitch	Bld#	RH	LH		
16-18' - RB, SK	13-3/4 R 15	3	AL	48-77342A40	992103	13-1/4 x 15	3	993103			
15-17' - RB, SK	13-1/4 R 17	3	AL	48-77344A40	992104	13-1/4 x 17	3	993104			
14-16' - RB, SK	13 R 19	3	AL	48-77346A40	992105	13-1/4 x 19	3	993105			
13-15' - RB, SK	12-3/4 R 21	3	AL	48-77348A40	992106	13-1/4 x 21	3	993106			

Key to abbreviations: AL: All Loads; CR: Cruisers; HB: Houseboat; HL: Heavy Loads; LL: Light Loads; RB: Runabouts; SB: Sailboat; SK: Skiboat; WB: Workboat; WD: Weedless

† For dual exhaust units only & requires thrust washer 23-819057. †† For all units 1995 thru current. Requires thrust washer 13191A1.  
 \* If currently using uncupped propeller, use cupped propeller having 2" less pitch. Boats with power trim use same pitch.  
 \* Requires special exhaust snout Part No. F744116 for proper fit. ► LIMITED INVENTORY ITEMS.

## 7.5-10 HORSEPOWER

### Non-Thru Hub Exhaust & Pin Drive

BF 7.5 .....1978-87      BF 8 .....1987 & Newer      BF 100 (10 HP) .....All Years

Boat Length/Description	MICHIGAN MATCH REPLACEMENT PROPELLERS						Part No.	Rubber Hub Bushing
	Dia., Rot., Pitch	Bld#	Mat'l	OEM	Part No.			
14-16'	9 R 8	3	AL			012014		
14-16' - WD	9 R 8	3	AL			012006		
14-16' - LL	9 R 9	3	AL	58130-881-840ZA		012109		
12-14'	9 R 10	3	AL			012011		
12-14' - WD	9 R 10	3	AL			012076		
12-14' - LL	9-1/4 R 11	3	AL			012013		
12-14' - LL	9-1/4 R 12	3	AL			012010		

## 9.9-15 HORSEPOWER

### Thru Hub Exhaust & 8 Tooth Spline

BF 9.9 .....1988 & Newer      BF 15 .....All Years

Boat Length/Description	MICHIGAN MATCH REPLACEMENT PROPELLERS						Part No.	Rubber Hub Bushing
	Dia., Rot., Pitch	Bld#	Mat'l	OEM	Part No.			
HL, HB	9-3/4 R 6-1/2	3	AL	58110-ZV4-DT15		112004		
13-17' - AL	9-1/4 R 8	3	AL			102003		
12-15' - AL	9-1/4 R 9	3	AL	58130-ZV4-701ZA		102004		
12-15' - LL	9-1/4 R 10-1/2	3	AL	58130-ZV4-030ZA		102005		

## 25-30 HORSEPOWER

### Thru Hub Exhaust & 10 Tooth Spline

25 HP .....All Years      30 HP .....All Years

Boat Length/Description	MICHIGAN MATCH REPLACEMENT PROPELLERS						BALLISTIC STAINLESS STEEL PROPS			Rubber Hub Bushing
	Dia., Rot., Pitch	Bld#	Mat'l	OEM	Part No.	Dia. x Pitch	Bld#	RH		
14-17' - AL							10-1/8 x 13	3	305229	
13-15' - AL							10-1/8 x 15	3	305230	



Boat Length/Description	VORTEX XHS™ PERFORMANCE PROPELLERS						Part No.	Use XHS™ Hub Kit <b>119</b>
	Dia., Rot., Pitch	Bld#	Mat'l	OEM	Part No.			
	10-1/4 R 9	3	AL	58130-ZV7-009AH		992501		
	10-1/4 R 10	3	AL	58130-ZV7-010AH		992502		
	10-1/4 R 11	3	AL	58130-ZV7-011AH		992503		
	10-1/8 R 12	3	AL	58130-ZV7-012AH		992504		
	10-1/8 R 13	3	AL			992505		
	10-1/8 R 14	3	AL			992506		

"NEW" VORTEX™ - AVAILABLE SPRING OF 2004 SEASON.

## 35-50 HORSEPOWER Thru Hub Exhaust & 13 Tooth Spline

BF 35 .....1991-94      BF 45 .....1991-94  
 BF 40 .....1995 & Newer      BF 50/50A .....1995 & Newer

Boat Length/Description	MICHIGAN MATCH REPLACEMENT PROPELLERS						RAPTURE			BALLISTIC STAINLESS STEEL PROPS			
	Dia., Rot., Pitch	Bld#	Mat'l	OEM	Part No.	Dia. x Pitch	Bld#	Part No.	Dia. x Pitch	Bld#	RH	LH	
19-21' - AL, SK	12-1/4 R 10	3	AL	58130-ZV5-860ZA	032045								
19-21' - AL, SK	12-1/4 R 10	3	AL		*031072								
17-19' - AL, SK	12 R 11	3	AL		032044								
17-19' - AL, SK	12 R 11	3	AL		*031073								
16-17' - AL, SK	11-3/4 R 12	3	AL	58130-ZV5-850ZA	032043	10-1/2 x 12	3	033094					
15-17' - AL, SK	10-3/8 R 12	3	SS		113001								
15-17' - AL, SK	11-1/2 R 13	3	AL	58130-ZV5-000ZA	032042	10-1/2 x 13	3	033095	10-1/8 x 13	3	395929		
14-16' - AL, SK	11-1/4 R 14	3	AL		032040	10-1/2 x 14	3	033096					
13-15' - AL, SK	11 R 15	3	AL	58130-ZV5-870ZA	032040	10-1/2 x 15	3	033097	10-1/8 x 15	3	395930		
12-14' - AL, SK	10-3/4 R 16	3	AL		032039								

Rubber Hub Bushing



Boat Length/Description	VORTEX <sup>XHS</sup> PERFORMANCE PROPELLERS						RAPTURE <sup>XHS</sup>			BALLISTIC <sup>XHS</sup> STAINLESS STEEL PROPS			
	Dia., Rot., Pitch	Bld#	Mat'l	OEM	Part No.	Dia. x Pitch	Bld#	Part No.	Dia. x Pitch	Bld#	RH	LH	
	12 R 8	4	AL		992401								
	12 R 9	4	AL	58134-ZV5-009AH	992402								
19-21' - AL, SK	12 R 10	4	AL	58134-ZV5-010AH	992403								
17-19' - AL, SK	10-3/8 R 11	3	AL	58130-ZV5-011AH	992404								
15-17' - AL, SK	10-3/8 R 12	3	AL	58130-ZV5-012AH	992405								
15-17' - AL, SK	10-3/8 R 13	3	AL	58130-ZV5-013AH	992406								
14-16' - AL, SK	10 R 14	3	AL	58130-ZV5-014AH	992407								
13-15' - AL, SK	10 R 15	3	AL	58130-ZV5-015AH	992408								
12-14' - AL, SK	10 R 16	3	AL		992409								

Use XHS™ Hub Kit 113

\*"NEW" VORTEX™ - AVAILABLE SPRING OF 2004 SEASON.

## 75-90 HORSEPOWER (1995-98) Thru Hub Exhaust & 15 Tooth Spline

75 HP .....1995-98      90 HP .....1995-98

Boat Length/Description	VORTEX <sup>XHS</sup> PERFORMANCE PROPELLERS						RAPTURE <sup>XHS</sup>			BALLISTIC <sup>XHS</sup> STAINLESS STEEL PROPS			
	Dia., Rot., Pitch	Bld#	Mat'l	OEM	Part No.	Dia. x Pitch	Bld#	Part No.	Dia. x Pitch	Bld#	RH	LH	
19-24' - AL, SK	13-3/4 R 15	3	AL		992103	13-1/4 x 15	3	993103					
17-20' - AL, SK	13-1/4 R 17	3	AL		992104	13-1/4 x 17	3	993104					
16-19' - AL, SK	13 R 19	3	AL		992105	13-1/4 x 19	3	993105					
15-18' - AL, SK	12-3/4 R 21	3	AL		992106	13-1/4 x 21	3	993106					

Use XHS™ Hub Kit 102

Use Gearcase Adapter Ring supplied with propeller.

Boat Length/Description	MICHIGAN MATCH REPLACEMENT PROPELLERS						RAPTURE			BALLISTIC STAINLESS STEEL PROPS			
	Dia., Rot., Pitch	Bld#	Mat'l	OEM	Part No.	Dia. x Pitch	Bld#	Part No.	Dia. x Pitch	Bld#	RH	LH	
25' & Up - AL	14 R 11	3	AL	58130-ZW1-W01ZA	031054								
22' & Up - AL	14 R 13	3	AL	58130-ZW1-W11ZA	031055								
19-24' - AL, SK	13-3/4 R 15	3	AL	58130-ZW1-W21ZA	031041	13-5/8 x 15	3	335130					
19-24' - AL, SK	13-3/4 R 15	3	SS	58130-ZW1-W91	033016								
17-20' - AL, SK	13-1/4 R 17	3	AL	58130-ZW1-W31ZA	031042	13-1/2 x 17	3	335131					
17-20' - AL, SK	13-1/4 R 17	3	SS	58130-ZW1-V01	033017								
16-19' - AL, SK	13 R 19	3	AL	58130-ZW1-W61ZA	031043	13-3/8 x 19	3	335132					
16-19' - AL, SK	13 R 19	3	SS	58130-ZW1-V11	033018								
15-18' - AL, SK	12-3/4 R 21	3	AL	58130-ZW1-W41ZA	031044	13-1/8 x 21	3	335133					
15-18' - AL, SK	13 R 21	3	SS	58130-ZW1-V31	033019								
Up to 17' - LL	12-1/2 R 23	3	AL	58130-ZW1-W51ZA	031045								
High Performance						13-1/2 x 22	3	335134 (XL)					
High Performance						13-1/2 x 24	3	335135 (XL)					

Rubber Hub Bushing



Key to abbreviations: AL: All Loads; CR: Cruisers; HB: Houseboat; HL: Heavy Loads; LL: Light Loads; RB: Runabouts; SB: Sailboat; SK: Skiboat; WB: Workboat; WD: Weedless

\* Indicates a cupped propeller.      ▶ LIMITED INVENTORY ITEMS.



## 75-130 HORSEPOWER (1998 & NEWER)

Thru Hub Exhaust & 15 Tooth Spline

75 HP .....1999 & Newer      115 HP .....1998 & Newer  
 90 HP .....1999 & Newer      130 HP .....1998 & Newer

Boat Length/Description											
	Dia., Rot., Pitch	Bld#	Mat'l	OEM	Part No.		Dia. x Pitch	Bld#	RH	LH	
19-24' - AL, SK	13-3/4 R 15	3	AL		<b>992103</b>		13-1/4 x 15	3	<b>993103</b>		
17-20' - AL, SK	13-1/4 R 17	3	AL		<b>992104</b>		13-1/4 x 17	3	<b>993104</b>		
16-19' - AL, SK	13 R 19	3	AL		<b>992105</b>		13-1/4 x 19	3	<b>993105</b>		
15-18' - AL, SK	12-3/4 R 21	3	AL		<b>992106</b>		13-1/4 x 21	3	<b>993106</b>		

Use XHS™ Hub Kit **107**  
 Use Gearcase Adapter Ring supplied with propeller.

Boat Length/Description											
	Dia., Rot., Pitch	Bld#	Mat'l	OEM	Part No.		Dia. x Pitch	Bld#	RH	LH	
25' & Up - AL	14 R 11	3	AL	58130-ZW1-W01ZA	<b>031054</b>						
22' & Up - AL	14 R 13	3	AL	58130-ZW1-W11ZA	<b>031055</b>						
19-24' - AL, SK	13-3/4 R 15	3	AL	58130-ZW1-W21ZA	<b>031041</b>		13-5/8 x 15	3	<b>335130</b>		
19-24' - AL, SK	13-3/4 R 15	3	SS	58130-ZW1-W91	<b>033016</b>						
17-20' - AL, SK	13-1/4 R 17	3	AL	58130-ZW1-W31ZA	<b>031042</b>		13-1/2 x 17	3	<b>335131</b>		
17-20' - AL, SK	13-1/4 R 17	3	SS	58130-ZW1-V01	<b>033017</b>						
16-19' - AL, SK	13 R 19	3	AL	58130-ZW1-W61ZA	<b>031043</b>		13-3/8 x 19	3	<b>335132</b>		
16-19' - AL, SK	13 R 19	3	SS	58130-ZW1-V11	<b>033018</b>						
15-18' - AL, SK	12-3/4 R 21	3	AL	58130-ZW1-W41ZA	<b>031044</b>		13-1/8 x 21	3	<b>335133</b>		
15-18' - AL, SK	13 R 21	3	SS	58130-ZW1-V31	<b>033019</b>						
Up to 17' - LL	12-1/2 R 23	3	AL	58130-ZW1-W51ZA	<b>031045</b>						
High Performance							13-1/2 x 22	3	<b>335134</b>		
High Performance							13-1/2 x 24	3	<b>335135</b>		

Rubber Hub Bushing

Key to abbreviations: AL: All Loads; CR: Cruisers; HB: Houseboat; HL: Heavy Loads; LL: Light Loads; RB: Runabouts; SB: Sailboat; SK: Skiboat; WB: Workboat; WD: Weedless



**VORTEX™ XHS™**  
PERFORMANCE PROPELLERS





**RAPTURE™ XHS™**





**BALLISTIC™**  
STAINLESS STEEL PROPS

## 200, 225 HORSEPOWER Thru Hub Exhaust & 15 Tooth Spline

200 HP .....2003 & Newer      225 HP .....2003 & Newer

Boat Length/Description										
	Dia., Rot., Pitch	Bld#	Mat'l	OEM	Part No.	Dia. x Pitch	Bld#	RH	LH	
Cruisers	15-1/4 R 15	3	AL	391535	992002	14-1/4 x 15	3	993002	993012	
20-26' - Runabouts	15 R 17	3	AL	177134	992003	14-1/4 x 17	3	993003	993013	
18-22' - Runabouts	14-1/2 R 19	3	AL	177135	992004	14-1/4 x 19	3	993004	993014	
16-20' - Runabouts	14-1/4 R 21	3	AL	177136	992005	14-1/4 x 21	3	993005	993015	
15-19' - Runabouts	14 R 23	3	AL	177137	992006	14-1/4 x 23	3	993006	993016	
						14-1/4 x 25	3	993007	993017	
21-26' - Runabouts	15 R 16	4	AL		992202					
19-22' - Runabouts	14-1/2 R 18	4	AL		992203					
17-20' - Runabouts	14 R 20	4	AL		992204					

Use XHS™  
Hub Kit  
**107**

Boat Length/Description										
	Dia., Rot., Pitch	Bld#	Mat'l	OEM	Part No.	Dia. x Pitch	Bld#	RH	LH	
CR, HB	16 R 11	3	AL	48-78112A40	031021					
CR, HB	16 R 12	3	AL	48-16436A40	031063					
CR, HB	16 R 13	3	AL	48-78114A40	031022					
22-25' - AL	16 R 14	3	AL	48-16438A40	031050					
21-24' - AL	15-1/4 R 15	3	AL	48-78116A40	031023	14-7/8 x 15	3	345131		
21-24' - AL	14-1/2 R 15	3	SS	48-16312A4	033002					
20-23' - AL, SK	16 R 16	3	AL	48-16440A40	031051					
19-23' - AL, SK	14-1/2 R 17	3	AL	48-78118A40	031024	14-3/4 x 17	3	345132	345162	
19-23' - AL, SK	14-1/2 R 17	3	SS	48-16314A4	033003					
19-23' - AL, SK	15 R 17	3	AL	48-832828A45	031064					
19-22' - AL, SK	15-1/2 R 18	3	AL	48-11324A45	031052					
18-22' - AL, SK	14 R 19	3	AL	48-78120A40	031025	14-1/2 x 19	3	345133	345163	
18-22' - AL, SK	14 R 19	3	SS	48-16316A4	033004					
18-22' - AL, SK	14-1/2 R 19	3	AL	48-832830A45	031065					
18-20' - AL, SK	13-3/4 R 21	3	AL	48-78122A40	031026	14-3/8 x 21	3	345134	345164	
18-20' - AL, SK	13-3/4 R 21	3	SS	48-16318A4	033005					
18-20' - AL, SK	14-1/4 R 21	3	AL	48-832832A45	031066					
17-20' - AL, SK	13-1/2 R 23	3	AL	48-78124A40	031027	14-1/4 x 23	3	345135	345165	
17-20' - AL, SK	13-1/2 R 23	3	SS	48-16320A4	033006					
17-20' - AL, SK	14 R 23	3	AL	48-832834A45	031068					
Up to 18'	13-3/8 R 25	3	AL	48-78126A40	031067	14-1/4 x 25	3	345136		
High Performance						14-1/2 x 22	3	345141	(XL)	
High Performance						14-1/2 x 24	3	345137	(XL)	
High Performance (EFI Engine)						14 x 24	3	345139	(XL)	
High Performance						14-1/2 x 26	3	345138	(XL)	
High Performance (EFI Engine)						14 x 26	3	345140	(XL)	
<b>High Performance 4 Blade Propellers</b>										
50-62 MPH	13-3/4 R 22	4	SS		033038	13-3/4 x 23	4	435135	(XL)	
55-67 MPH	13-3/4 R 24	4	SS		033040	13-3/4 x 25	4	435136	(XL)	
60-72 MPH	13-3/4 R 26	4	SS		033042	13-3/4 x 27	4	435137	(XL)	
<b>Stainless Steel Performance Propellers for Offshore or Heavy Boats</b>										
18-20' - AL, SK	14-3/4 R 21	3	SS	48-13702A41	033032					
17-20' - AL, SK	14-5/8 R 23	3	SS	48-13704A41	033034					
16-19' - AL, SK	14-1/2 R 25	3	SS	48-13706A41	033036					
	15-1/4 L 19	3	SS	48-13701A41	033029					
	14-3/4 L 21	3	SS	48-13703A41	033031					
	14-5/8 L 23	3	SS	48-13705A41	033033					
	14-1/2 L 25	3	SS	48-13707A41	033035					

Rubber  
Hub  
Bushing



Key to abbreviations: AL: All Loads; CR: Cruisers; HB: Houseboat; HL: Heavy Loads; LL: Light Loads; RB: Runabouts; SB: Sailboat; SK: Skiboat; WB: Workboat; WD: Weedless

- Larger blade area design used primarily on 1997 & newer applications.
- \* To avoid damage or injury, replace standard trim tab with trim tab 822777A1.
- NOTE: When replacing Flo-Torq II™ plastic hub props, aft castle washer 12-31211A2 and conductivity washer 13-42351-1 are required in addition to other hardware supplied with original propeller. For complete details see page 22.
- Use thrust washer A-9500-110 provided with propeller.
- ▶ LIMITED INVENTORY ITEMS.

4-10 HORSEPOWER								
Thru Hub Exhaust & 8 Tooth Spline								
MODEL 40	.....1973-75	BF 7.5	.....1978-87	BF 100 (10 HP)	.....All Years			
MODEL 45	.....1973-81	BF 8	.....1987 & Newer					
Boat Length/Description							Part No.	Rubber Hub Bushing
	Dia., Rot., Pitch	Bld#	Mat'l	OEM				
Std. Replacement	9 R 9	2	AL	48-47922A10		<b>032021</b>		
Lt. Runabouts, LL	9 R 10	2	AL	48-47926A10		<b>032019</b>		
14-16' - AL, SK	9 R 7	3	AL	48-47670A10		<b>032020</b>		

6-15 HORSEPOWER								
Thru Hub Exhaust & 8 Tooth Spline								
6, 8, 9.9 HP (2-Stroke)	.....1986 & Newer	10 HP	.....1995 & Newer	15 HP (2 & 4-Stroke)	.....1989 & Newer			
9.9 HP	.....2002	10, 15 HP (Sea Pro/Marathon)	..1995 & Newer					
Does not include Bigfoot.								
Boat Length/Description							Part No.	Rubber Hub Bushing
	Dia., Rot., Pitch	Bld#	Mat'l	OEM				
HB, WB	9-3/4 R 5-1/2	3	AL	48-828148A12		<b>032060</b>		
HB, WB	9-3/4 R 6-1/2	3	AL	48-828150A12		<b>032058</b>		
16-20' - AL	9-1/4 R 7	3	AL	48-828152A12		<b>032056</b>		
14-19' - AL	9 R 8	3	AL	48-828154A12		<b>032054</b>		
14-18' - AL	9 R 9	3	AL	48-828156A12		<b>032052</b>		
14-16' - AL	9 R 10-1/2	3	AL	48-828158A12		<b>032050</b>		

MERC 20								
Thru Hub Exhaust & 8 Tooth Spline								
Merc. 20	.....1963-81							
Boat Length/Description							Part No.	Rubber Hub Bushing
	Dia., Rot., Pitch	Bld#	Mat'l	OEM				
Std. Replacement	9-7/8 R 11	2	AL	48-33480A1		<b>032135</b>		
14-16' - AL, SK	10 R 9	3	AL	48-86962A4		<b>032136</b>		

9.9-25 HORSEPOWER									
Thru Hub Exhaust & 10 Tooth Spline									
9.9, 15 HP (Bigfoot, 4-Stroke)	...1999 & Newer	20 HP (Mercury)	.....1986 & Newer	25 HP (Mariner 2-Stroke)	.....1985 & Newer				
18 HP (Mercury)	.....1980-85	25 HP (Not 4-Stroke)	.....1980 & Newer	25 HP (Sea Pro/Marathon)	.....				
Boat Length/Description									Rubber Hub Bushing
	Dia., Rot., Pitch	Bld#	Mat'l	OEM	Part No.	Dia. x Pitch	Bld# RH		
15-19'	10-3/8 R 11	3	AL	48-19638A40	<b>031049</b>				
13-17'	10-3/8 R 13	3	AL	48-19640A40	<b>031048</b>	10-1/8 x 13	3	<b>305129</b>	
Up to 14'	10-1/4 R 14-1/2	3	AL	48-19642A40	<b>031047</b>	10-1/8 x 15	3	<b>305130</b>	

Boat Length/Description							Part No.	Use XHS™ Hub Kit <b>120</b>
	Dia., Rot., Pitch	Bld#	Mat'l	OEM				
10-1/4 R 9	3	AL	48-19636A10		<b>992501</b>			
10-1/4 R 10	3	AL	48-19637A10		<b>992502</b>			
10-1/4 R 11	3	AL	48-19638A40		<b>992503</b>			
10-1/8 R 12	3	AL	48-19639A40		<b>992504</b>			
10-1/8 R 13	3	AL	48-19640A40		<b>992505</b>			
10-1/8 R 14	3	AL	48-19642A40		<b>992506</b>			

"NEW" VORTEX™ - AVAILABLE SPRING OF 2004 SEASON.

Key to abbreviations: AL: All Loads; CR: Cruisers; HB: Houseboat; HL: Heavy Loads; LL: Light Loads; RB: Runabouts; SB: Sailboat; SK: Skiboat; WB: Workboat; WD: Weedless

**15-25 HORSEPOWER • MARINER**  
**Non-Thru Hub & Pin Drive**

15 HP .....1976-81                      W15 .....1977-85                      25 HP .....1977-79  
 15A .....1979-82                      20 HP .....1976-79

Boat Length/Description	MICHIGAN MATCH REPLACEMENT PROPPELLERS						Part No.	Rubber Hub Bushing
	Dia., Rot., Pitch	Bld#	Mat'l	OEM	Part No.			
HB, SB	9-1/4 R 7	3	AL	48-96628	012102			
12-14' - HL	9 R 10	3	AL	48-96625	012011			
12-14' - AL, SK	9-1/4 R 11	3	AL	48-96623	012013			
12-14' - LL	9-1/4 R 12	3	AL	48-96622	012010			

**25-30 HORSEPOWER • MARINER • THRU HUB EXHAUST**  
**Thru Hub Exhaust & 10 Tooth Spline**

25 HP .....1980-84                      28 HP .....1976-79                      30 HP .....1979-90

Boat Length/Description	MICHIGAN MATCH REPLACEMENT PROPPELLERS						Part No.	Rubber Hub Bushing
	Dia., Rot., Pitch	Bld#	Mat'l	OEM	Part No.			
16-18' - AL, SK	9-7/8 R 9	3	AL	48-81647	022001			
16-18' - AL, SK	9-7/8 R 9	3	AL		★021001			
14-17' - AL, SK	9-7/8 R 10-1/2	3	AL	48-81649	022002			
13-16' - LL	9-3/8 R 12	3	AL	48-82826	022003			

**MARK 35-58A, MODELS 300-500 (THRU 1961)**  
**Thru Hub Exhaust & 11 Tooth Spline**

Mark 35A, 50, 55 .....1956-61  
 Mark 58, 58A  
 Models 300, 350, 400, 500

Boat Length/Description	MICHIGAN MATCH REPLACEMENT PROPPELLERS						Part No.	Rubber Hub Bushing
	Dia., Rot., Pitch	Bld#	Mat'l	OEM	Part No.			
16-17' - AL, SK	10 R 10	3	AL	48-22575A2	032077			

**MODELS 300-500 (1962-69)**  
**Thru Hub Exhaust & 11 Tooth Spline**

MODELS 300, 350, 400, 450, 500 ..1962-69

Boat Length/Description	MICHIGAN MATCH REPLACEMENT PROPPELLERS						Part No.	Rubber Hub Bushing
	Dia., Rot., Pitch	Bld#	Mat'l	OEM	Part No.			
17-19' - AL, SK	10-1/4 R 10	3	AL	48-33774A1	032084			
16-17' - AL, SK	10-1/4 R 11	3	AL	48-38098A1	032085			
14-16' - AL, SK	10-1/4 R 12	3	AL	48-38094A1	032086			
14-16' - LL	10-1/4 R 13	3	AL	48-38090A1	032087			

**MODELS 400-500 (1970-73)**  
**Thru Hub Exhaust & 13 Tooth Spline**

MODELS 400, 402, 500 .....1970-73

Boat Length/Description	MICHIGAN MATCH REPLACEMENT PROPPELLERS						Part No.	Rubber Hub Bushing
	Dia., Rot., Pitch	Bld#	Mat'l	OEM	Part No.			
14-16' - AL, SK	10-1/4 R 13	3	AL	48-56236A1	032099			

Key to abbreviations: AL: All Loads; CR: Cruisers; HB: Houseboat; HL: Heavy Loads; LL: Light Loads; RB: Runabouts; SB: Sailboat; SK: Skiboat; WB: Workboat; WD: Weedless

★ Indicates a cupped propeller.                      ▶ LIMITED INVENTORY ITEMS.

**MODELS 402-500 (1974-76), 650, 60 HP**  
**Thru Hub Exhaust & 13 Tooth Spline**

MODEL 402-500 .....1974-76                      MODEL 650 .....1972-76                      60 HP (Mariner) .....1976

Boat Length/Description	MICHIGAN MATCH REPLACEMENT PROPELLERS						RAPTURE			BALLISTIC STAINLESS STEEL PROPS			
	Dia., Rot., Pitch	Bld#	Mat'l	OEM	Part No.	Dia. x Pitch	Bld#	Part No.	Dia. x Pitch	Bld#	RH	LH	
19-22' - AL	12-1/4 R 10	3	AL	4861812A1	032045	10-1/2 x 10	3	033093					
19-22' - AL	12-1/4 R 10	3			*031072								
17-19' - AL, SK	12 R 11	3	AL	48-61814A1	032044								
17-19' - AL, SK	12 R 11	3	AL		*031073								
16-17' - AL, SK	10-5/8 R 12	3	AL		113001	10-1/2 x 12	3	033094					
15-18' - AL, SK	11-3/4 R 12	3	AL	48-61816A1	032043								
14-16' - LL	11-1/2 R 13	3	AL	48-61818A1	032042	10-1/2 x 13	3	033095	10-1/8 x 13	3	395929		
12-14' - LL	11-1/4 R 14	3	AL	48-61820A1	032041	10-1/2 x 14	3	033096					
12-14' - LL	11 R 15	3	AL	48-61822A1	032040	10-1/2 x 15	3	033097	10-1/8 x 15	3	395930		
12-14' - LL	10-3/4 R 16	3	AL	48-61824A1	032039								

Rubber Hub Bushing



Boat Length/Description	VORTEX XHS™ PERFORMANCE PROPELLERS					
	Dia., Rot., Pitch	Bld#	Mat'l	OEM	Part No.	
	12 R 8	4	AL		992401	
	12 R 9	4	AL		992402	
19-22' - AL, SK	12 R 10	4	AL		992403	
17-19' - AL, SK	10-3/8 R 11	3	AL	48-85632A40	992404	
16-17' - AL, SK	10-3/8 R 12	3	AL	48-73134A40	992405	
14-16' - LL	10-3/8 R 13	3	AL	48-73136A40	992406	
12-14' - LL	10 R 14	3	AL	48-73138A40	992407	
12-14' - LL	10 R 15	3	AL	48-73140A40	992408	
12-14' - LL	10 R 16	3	AL	48-73142A40	992409	

Use XHS™ Hub Kit  
**114**

\*"NEW" VORTEX™ - AVAILABLE SPRING OF 2004 SEASON.

**25-80 HORSEPOWER**  
**Thru Hub Exhaust & 13 Tooth Spline**

MODEL 402-500-700 .....1977-84                      40 HP (2 & 4-Stroke) (Not Bigfoot) .1977 & Newer                      55 HP (Mercury/Sea Pro/Marathon) 1995 & Newer  
 25 HP Bigfoot (4-Stroke) .....1999 & Newer                      40 HP (Sea Pro/Marathon) .....1977 & Newer                      60 HP (Not Bigfoot or Sea Pro) ...1978 & Newer  
 30 HP (2 & 4-Stroke) .....1994 & Newer                      45 HP .....1986-89                      60 HP (2-Stroke) .....1978 & Newer  
 30 HP (Sea Pro/Marathon) .....1994 & Newer                      48 HP (Mariner) .....All Years                      70 HP .....Thru 1983  
 35 HP .....1984-89                      50 HP (2 & 4-Stroke) (Not Bigfoot) .1977 & Newer

Boat Length/Description	MICHIGAN MATCH REPLACEMENT PROPELLERS						RAPTURE			BALLISTIC STAINLESS STEEL PROPS			
	Dia., Rot., Pitch	Bld#	Mat'l	OEM	Part No.	Dia. x Pitch	Bld#	Part No.	Dia. x Pitch	Bld#	RH	LH	
19' and Up	12-1/2 R 8	3	AL	48-42738A10	032141								
19' & Up	12-1/2 R 8	3	AL		*031070								
17-19' - AL, SK	11-1/4 R 10	3	AL	48-73132A40	031015								
16-18' - AL, SK	12 R 10-1/2	3	AL	48-42740A10	032142								
16-18' - AL, SK	12 R 10-1/2	3	AL		*031071								
16-18' - AL, SK	10-7/8 R 11	3	AL	48-85632A40	031053								
15-17' - AL, SK	10-3/4 R 12	3	AL	48-816702A40	031056								
15-17' - AL, SK	10-5/8 R 12	3	AL	48-73134A40	031016	10-1/2 x 12	3	033089					
15-17' - AL, SK	10-5/8 R 12	3	SS	48-79792A5	033001								
14-17' - AL, SK	10-1/2 R 13	3	AL	48-816704A40	031057								
14-17' - AL, SK	10-3/8 R 13	3	AL	48-73136A40	031017	10-1/2 x 13	3	033090	10-1/8 x 13	3	395129		
14-16' - LL	10-3/8 R 14	3	AL	48-816706A40	031058								
14-16' - LL	10-1/4 R 14	3	AL	48-73138A40	031018	10-1/2 x 14	3	033091					
13-15' - LL	10-1/4 R 14	3	SS	48-76230A5	033028								
Up to 15' - LL	10-1/8 R 15	3	AL	48-73140A40	031019	10-1/2 x 15	3	033092	10-1/8 x 15	3	395130		
Up to 15' - LL	10 R 17	3	AL	48-73144A40	031020								

Rubber Hub Bushing

Key to abbreviations: AL: All Loads; CR: Cruisers; HB: Houseboat; HL: Heavy Loads; LL: Light Loads; RB: Runabouts; SB: Sailboat; SK: Skiboat; WB: Workboat; WD: Weedless

\* Indicates a cupped propeller.

▶ LIMITED INVENTORY ITEMS.



## 25-80 HORSEPOWER

### Thru Hub Exhaust & 13 Tooth Spline

MODEL 402-500-700 . . . . .1977-84	40 HP (2 & 4-Stroke) (Not Bigfoot) .1977 & Newer	55 HP (Mercury/Sea Pro/Marathon) 1995 & Newer
25 HP Bigfoot (4-Stroke) . . . . .1999 & Newer	40 HP (Sea Pro/Marathon) . . . . .1977 & Newer	60 HP (Not Bigfoot or Sea Pro) . . .1978 & Newer
30 HP (2 & 4-Stroke) . . . . .1994 & Newer	45 HP . . . . .1986-89	60 HP (2-Stroke) . . . . .1978 & Newer
30 HP (Sea Pro/Marathon) . . . . .1994 & Newer	48 HP (Mariner) . . . . .All Years	70 HP . . . . .Thru 1983
35 HP . . . . .1984-89	50 HP (2 & 4-Stroke) (Not Bigfoot) .1977 & Newer	



Boat Length/Description	VORTEX <sup>XHS</sup> PERFORMANCE PROPELLERS						
	Dia.,	Rot.,	Pitch	Bld#	Mat'l	OEM	Part No.
	12	R	8	4	AL		992401
	12	R	9	4	AL		992402
19-22' - AL,SK	12	R	10	4	AL		992403
17-19' - AL, SK	10-3/8	R	11	3	AL	48-85632A40	992404
16-17' - AL, SK	10-3/8	R	12	3	AL	48-73134A40	992405
14-16' - LL	10-3/8	R	13	3	AL	48-73136A40	992406
12-14' - LL	10	R	14	3	AL	48-73138A40	992407
12-14' - LL	10	R	15	3	AL	48-73140A40	992408
12-14' - LL	10	R	16	3	AL	48-73142A40	992409

Use XHS™  
Hub Kit  
**114**

"NEW" VORTEX™ - AVAILABLE SPRING OF 2004 SEASON.

## 40-140 HORSEPOWER

### Thru Hub Exhaust & 15 Tooth Spline

40, 50 HP (Bigfoot, 4-Stroke) . . . . .All Years	90 HP (2 & 4-Stroke) . . . . .1978 & Newer	▼650 2 Cyl. . . . .Thru 1971
60 HP (Bigfoot/Sea Pro Only, not 4-Stroke) 1995 & Newer	100 HP . . . . .1988 & Newer	▼800-850 6 Cyl. . . . .Thru 1972
60 HP (Sea Pro/Marathon) . . . . .1995 & Newer	115 HP . . . . .1978 & Newer	▼800-850 4 Cyl. . . . .1972-77
70 HP . . . . .1987-89	115 HP 4-Stroke . . . . .2001 & Newer	▼900-1500 Models . . . . .Thru 1977
75 HP (2 & 4-Stroke) . . . . .1984 & Newer	125 HP . . . . .1994 & Newer	▼80 HP (Yamaha) . . . . .1977
75 HP (Sea Pro/Marathon) . . . . .All Years	140 HP (Includes Sea Pro & Offshore) 1978 - 81	▼80 HP (Mariner) . . . . .1978-83
80 HP . . . . .1978-89	▼650 4 Cyl. (2:1) . . . . .1961-70	

Boat Length/Description	VORTEX <sup>XHS</sup> PERFORMANCE PROPELLERS						RAPTURE <sup>XHS</sup>				
	Dia.,	Rot.,	Pitch	Bld#	Mat'l	OEM	Part No.	Dia. x Pitch	Bld#	RH	LH
16-18' - RB, SK	13-3/4	R	15	3	AL		992103	13-1/4 x 15	3	993103	
15-17' - RB, SK	13-1/4	R	17	3	AL		992104	13-1/4 x 17	3	993104	
14-16' - RB, SK	13	R	19	3	AL		992105	13-1/4 x 19	3	993105	
13-15' - RB, SK	12-3/4	R	21	3	AL		992106	13-1/4 x 21	3	993106	

Use XHS™  
Hub Kit  
**102**  
Use Gearcase  
Adapter Ring supplied  
with propeller.

Boat Length/Description	MICHIGAN MATCH REPLACEMENT PROPELLERS						BALLISTIC <sup>TM</sup> STAINLESS STEEL PROPS				
	Dia.,	Rot.,	Pitch	Bld#	Mat'l	OEM	Part No.	Dia. x Pitch	Bld#	RH	LH
25' & Up - AL	14	R	11	3	AL	48-77338A40	▼031054				
22' & Up - AL	14	R	13	3	AL	48-77340A40	▼031055				
19-24' - AL, SK	13-3/4	R	15	3	AL	48-77342A40	※031041	13-5/8 x 15	3	※335130	
19-24' - AL, SK	13-3/4	R	15	3	SS	48-16986A5	※033016				
17-20' - AL, SK	13-1/4	R	17	3	AL	48-77344A40	※031042	13-1/2 x 17	3	※335131	
17-20' - AL, SK	13-1/4	R	17	3	SS	48-16988A5	※033017				
16-19' - AL, SK	13	R	19	3	AL	48-77346A40	▼031043	13-3/8 x 19	3	※335132	
16-19' - AL, SK	13	R	19	3	SS	48-16990A40	▼033018				
15-18' - AL, SK	12-3/4	R	21	3	AL	48-77348A40	▼031044	13-1/8 x 21	3	※335133	
15-18' - AL, SK	13	R	21	3	SS	48-16992A40	▼033019				
Lt. Runabouts, LL	12-1/2	R	23	3	AL	48-77350A40	▼031045				
High Performance								13-1/2 x 22	3	※335134 (XL)	
High Performance								13-1/2 x 24	3	※335135 (XL)	

Rubber  
Hub  
Bushing

Key to abbreviations: AL: All Loads; CR: Cruisers; HB: Houseboat; HL: Heavy Loads; LL: Light Loads; RB: Runabouts; SB: Sailboat; SK: Skiboat; WB: Workboat; WD: Weedless



▼ When using rubber hub propeller, use thrust washer 13191A1.  
 ※ To avoid damage or injury, replace standard trim tab with trim tab 822777A1 and thrust washer 13191A1 MUST be used.

135-300 HORSEPOWER • V-6 GEARCASE



Thru Hub Exhaust & 15 Tooth Spline

135 HP .....1987 & Newer	220 HP .....1987-88	275 HP .....1990-94
150 HP .....1978 & Newer	225 HP .....1980 & Newer	300 HP .....1983, 1999 & Newer
175 HP .....1978 & Newer	225 HP (Sea Pro/Marathon) ....All Years	3.4 Litre .....1984-86
200 HP .....1978 & Newer	250 HP .....1994 & Newer	

Includes DFI, EFI, Magnum, Offshore, Optimax, Sea Pro & XRI      Use thrust washer 13171      Add 4" pitch for twin motors

Boat Length/Description										
	Dia., Rot., Pitch	Bld#	Mat'l	OEM	Part No.	Dia. x Pitch	Bld#	RH	LH	
21-24' - AL	15-1/4 R 15	3	AL		992002	14-1/4 x 15	3	993002	993012	
19-23' - AL, SK	15 R 17	3	AL		992003	14-1/4 x 17	3	993003	993013	
18-22' - AL, SK	14-1/2 R 19	3	AL		992004	14-1/4 x 19	3	993004	993014	
18-20' - AL, SK	14-1/4 R 21	3	AL		992005	14-1/4 x 21	3	993005	993015	
17-20' - AL, SK	14 R 23	3	AL		992006	14-1/4 x 23	3	993006	993016	
						14-1/4 x 25	3	993007	993017	
20-23' - AL, SK	15 R 16	4	AL		992202					
19-22' - AL, SK	14-1/2 R 18	4	AL		992203					
	14 R 20	4	AL		992204					

Use XHS™  
Hub Kit  
**102**

Boat Length/Description										
	Dia., Rot., Pitch	Bld#	Mat'l	OEM	Part No.	Dia. x Pitch	Bld#	RH	LH	
CR, HB	16 R 11	3	AL	48-78112A40	031021					
CR, HB	16 R 12	3	AL	48-16436A40	031063					
CR, HB	16 R 13	3	AL	48-78114A40	031022					
22-25' - AL	16 R 14	3	AL	48-16438A40	031050					
21-24' - AL	15-1/4 R 15	3	AL	48-78116A40	031023	14-7/8 x 15	3	345131		
21-24' - AL	14-1/2 R 15	3	SS	48-16312A4	033002					
20-23' - AL, SK	16 R 16	3	AL	48-16440A40	031051					
19-23' - AL, SK	14-1/2 R 17	3	AL	48-78118A40	031024	14-3/4 x 17	3	345132	345162	
19-23' - AL, SK	14-1/2 R 17	3	SS	48-16314A4	033003					
19-23' - AL, SK	15 R 17	3	AL	48-832828A45	031064					
19-22' - AL, SK	15-1/2 R 18	3	AL	48-11324A45	031052					
18-22' - AL, SK	14 R 19	3	AL	48-78120A40	031025	14-1/2 x 19	3	345133	345163	
18-22' - AL, SK	14 R 19	3	SS	48-16316A4	033004					
18-22' - AL, SK	14-1/2 R 19	3	AL	48-832830A45	031065					
18-20' - AL, SK	13-3/4 R 21	3	AL	48-78122A40	031026	14-3/8 x 21	3	345134	345164	
18-20' - AL, SK	13-3/4 R 21	3	SS	48-16318A4	033005					
18-20' - AL, SK	14-1/4 R 21	3	AL	48-832832A45	031066					
17-20' - AL, SK	13-1/2 R 23	3	AL	48-78124A40	031027	14-1/4 x 23	3	345135	345165	
17-20' - AL, SK	13-1/2 R 23	3	SS	48-16320A4	033006					
17-20' - AL, SK	14 R 23	3	AL	48-832834A45	031068					
Up to 18'	13-3/8 R 25	3	AL	48-78126A40	031067	14-1/4 x 25	3	345136		
High Performance						14-1/2 x 22	3	345141	(XL)	
High Performance						14-1/2 x 24	3	345137	(XL)	
High Performance (EFI Engine)						14 x 24	3	345139	(XL)	
High Performance						14-1/2 x 26	3	345138	(XL)	
High Performance (EFI Engine)						14 x 26	3	345140	(XL)	
<b>High Performance 4 Blade Propellers</b>										
50-62 MPH	13-3/4 R 22	4	SS		033038	13-3/4 x 23	4	345135	(XL)	
55-67 MPH	13-3/4 R 24	4	SS		033040	13-3/4 x 25	4	345136	(XL)	
60-72 MPH	13-3/4 R 26	4	SS		033042	13-3/4 x 27	4	345137	(XL)	
<b>Stainless Steel Performance Propellers for Offshore or Heavy Boats</b>										
18-20' - AL, SK	14-3/4 R 21	3	SS	48-13702A41	033032					
17-20' - AL, SK	14-5/8 R 23	3	SS	48-13704A41	033034					
16-19' - AL, SK	14-1/2 R 25	3	SS	48-13706A41	033036					
	15-1/4 L 19	3	SS	48-13701A41	033029					
	14-3/4 L 21	3	SS	48-13703A41	033031					
	14-5/8 L 23	3	SS	48-13705A41	033033					
	14-1/2 L 25	3	SS	48-13707A41	033035					

Rubber  
Hub  
Bushings

■ Larger blade area design used primarily on 1997 & newer applications.      ● Use thrust washer A-9500-110 provided with propeller.  
 \* To avoid damage or injury, replace standard trim tab with trim tab 822777A1.      ► LIMITED INVENTORY ITEMS.  
 NOTE: When replacing Flo-Torq II™ plastic hub props, aft castle washer 12-31211A2 and conductivity washer 13-42351-1 are required in addition to other hardware supplied with original propeller. For complete details see page 22.

# Replacing a Flo-Torq™ Hub with Michigan Propellers

## Replacing a Flo-Torq II™ Drop In Hub Design with Michigan Propellers

Propellers supplied from Mercury™, Mariner™ and Force® since 1996 come with Flo-Torq II™ drop in hubs equipped with attaching hardware A,B,C,F & G per the following illustrations. When switching to Michigan Match™ or Rapture™ propellers, change the attaching hardware set up as follows.

When converting to a Michigan Propeller on a **4 cylinder gear-case**, eliminate B & C, replace A with H and use existing hardware F & G.

When converting to a Michigan Propeller on a **V-6 gear-case**, eliminate B & C and use A, D, E, F & G as attaching hardware (D & E replaces C). Be sure to use high-performance trim tab 822777A1 for Rapture™ installations.

Michigan Wheel offers the following attaching hardware kits for these installations:

- 990312 Includes D & E for the V-6 gearcase.
- 990332 Includes Forward Thrust Washer H for 4-cylinder gearcase.
- 9661-1 Includes A, D, E, F & G for the V-6 gearcase.
- 9660-1 Includes H, F & G for the 4 cylinder gearcase.

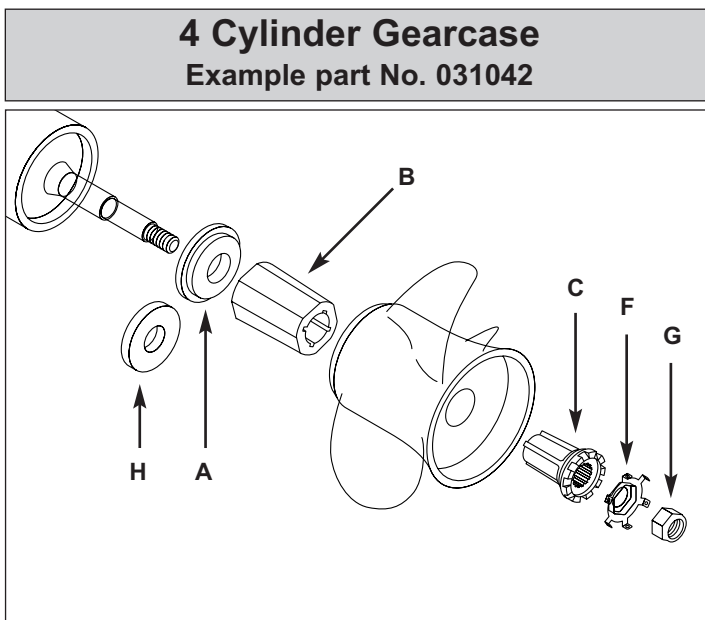

- A) 12-835467 Forward Thrust Washer
- B) 827703 Plastic Drive Sleeve
- C) 826074-1 Metal Sleeve adapter
- D) 13-42351-1 Conductivity (star) washer

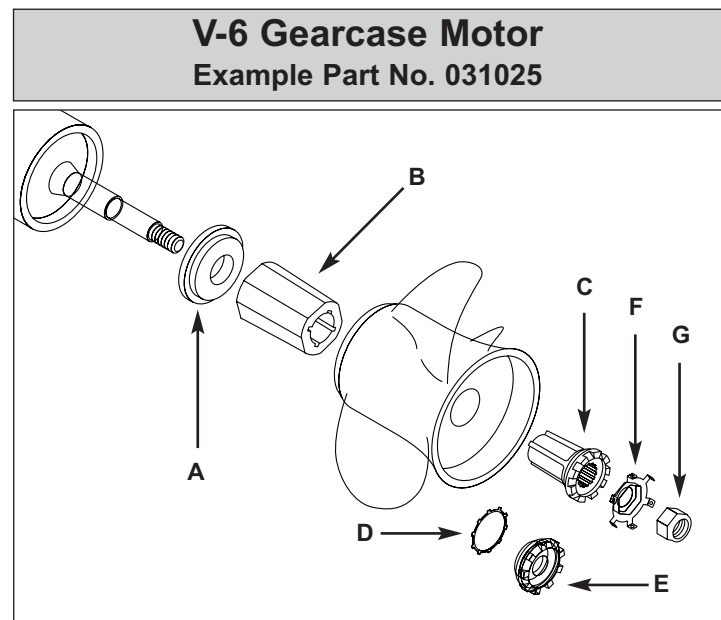

- E) 12-31211A2 Aft Castle Thrust Washer
- F) 14-816629 Locking Tab Washer
- G) 11-827614 Shaft Prop Nut
- H) 13191A1 Forward Thrust Washer

## 9.9-18 HORSEPOWER

### Thru Hub Exhaust & 14 Tooth Spline

9.9 HP .....1984 & Newer      12 HP .....1985-88      15, 18 HP .....1985 & Newer  
 9.9 HP (4-Stroke) .....2000 & Newer      15 HP (4-Stroke) .....2000 & Newer      18 HP (4-Stroke) .....2001 & Newer

Boat Length/Description	MICHIGAN MATCH REPLACEMENT PROPELLERS						Part No.			Rubber Hub Bushing
	Dia., Rot., Pitch	Bld#	Mat'l	OEM						
14-18' - AL	9.2 R 6.9	3	AL	362-64105-0		<b>142015</b>				
12-16' - AL	9.2 R 8.4	3	AL	362-64102-0		<b>142017</b>				
10-14' - AL	9.2 R 9.8	3	AL	362-64108-0		<b>142019</b>				

## 25-30 HORSEPOWER

### Thru Hub Exhaust & 10 Tooth Spline

25 HP .....1986 & Newer      30 HP .....1985 & Newer

Boat Length/Description	MICHIGAN MATCH REPLACEMENT PROPELLERS						BALLISTIC STAINLESS STEEL PROPS				Rubber Hub Bushing
	Dia., Rot., Pitch	Bld#	Mat'l	OEM	Part No.	Dia. x Pitch	Bld#	RH	LH		
16-20' - AL	10.2 R 8.3	3	AL	346-64106-5	<b>142020</b>						
14-18' - AL	9.8 R 10.2	3	AL	346-64102-5	<b>142022</b>						
12-16' - AL	9.9 R 13.1	3	AL	346-64104-5	<b>142024</b>	10-1/8 x 13	3	<b>305429</b>			
12-16' - AL						10-1/8 x 15	3	<b>305430</b>			



Boat Length/Description	VORTEX XHS™ PERFORMANCE PROPELLERS						Part No.			Use XHS™ Hub Kit <b>122</b>
	Dia., Rot., Pitch	Bld#	Mat'l	OEM						
16-20' - AL	10-1/4 R 9	3	AL	34664-1015M		<b>992501</b>				
14-18' - AL	10-1/4 R 10	3	AL	34664-1025M		<b>992502</b>				
14-18' - AL	10-1/4 R 11	3	AL			<b>992503</b>				
14-18' - AL	10-1/8 R 12	3	AL	3R064-5250M		<b>992504</b>				
12-16' - AL	10-1/8 R 13	3	AL			<b>992505</b>				
12-16' - AL	10-1/8 R 14	3	AL	34664-1055M		<b>992506</b>				

"NEW" VORTEX™ - AVAILABLE SPRING OF 2004 SEASON.

## 35-50 HORSEPOWER

### Thru Hub Exhaust & 13 Tooth Spline

35 HP (35B only) .....Thru 1984      40 HP .....1984 & Newer      50 HP .....1992 & Newer  
 50 HP (50D only) .....1991

Boat Length/Description	MICHIGAN MATCH REPLACEMENT PROPELLERS						RAPIDFLO			Rubber Hub Bushing
	Dia., Rot., Pitch	Bld#	Mat'l	OEM	Part No.	Dia. x Pitch	Bld#	Part No.		
20' & Up - AL						10-1/2 x 10	3	<b>143001</b>		
17-21' - AL	10.6 R 11.3	3	AL	361-64113-0	<b>142001</b>					
16-17' - AL	10.6 R 11.7	3	AL	361-64114-0	<b>142002</b>	10-1/2 x 12	3	<b>143002</b>		
14-16' - AL	10.3 R 12.7	3	AL	348-64102-0	<b>142003</b>	10-1/2 x 13	3	<b>143003</b>		
12-14' - AL	10.2 R 13.9	3	AL	348-64103-0	<b>142004</b>	10-1/2 x 14	3	<b>143004</b>		
Up to 13' - AL						10-1/2 x 15	3	<b>143005</b>		



Boat Length/Description	VORTEX XHS™ PERFORMANCE PROPELLERS						Part No.			Use XHS™ Hub Kit <b>116</b>
	Dia., Rot., Pitch	Bld#	Mat'l	OEM						
	12 R 8	4	AL			<b>992401</b>				
	12 R 9	4	AL			<b>992402</b>				
20' & Up - AL	12 R 10	4	AL			<b>992403</b>				
17-21' - AL	10-3/8 R 11	3	AL	361-64113-0		<b>992404</b>				
16-17' - AL	10-3/8 R 12	3	AL	361-64114-0		<b>992405</b>				
14-16' - AL	10-3/8 R 13	3	AL	361-64102-0		<b>992406</b>				
12-14' - AL	10 R 14	3	AL	361-64103-0		<b>992407</b>				
Up to 13' - AL	10 R 15	3	AL			<b>992408</b>				
	10 R 16	3	AL			<b>992409</b>				

"NEW" VORTEX™ - AVAILABLE SPRING OF 2004 SEASON.

Key to abbreviations: AL: All Loads; CR: Cruisers; HB: Houseboat; HL: Heavy Loads; LL: Light Loads; RB: Runabouts; SB: Sailboat; SK: Skiboat; WB: Workboat; WD: Weedless

## 50-70 HORSEPOWER

### Thru Hub Exhaust

50 HP (50C only) .....1987-91      60 HP .....1986 & Newer      70 HP .....1981 & Newer  
 55 HP .....1981-88

Boat Length/Description	MICHIGAN MATCH REPLACEMENT PROPELLERS						RAPTURE			BALLISTIC STAINLESS STEEL PROPS			
	Dia., Rot., Pitch	Bld#	Mat'l	OEM	Part No.	Dia. x Pitch	Bld#	Part No.	Dia. x Pitch	Bld#	RH	LH	
CR, HB	11.6 R 11	3	AL	353-64103-0	142005	11-3/4 x 11	3	013080					
15-18' - AL, SK	11.5 R 13	3	AL	353-64105-0	142006	11-3/4 x 13	3	013081					
15-18' - AL, SK	12-1/2 R 13	3	SS		013024								
14-17' - AL, SK	11 R 15	3	AL	353-64107-0	142007	11-3/4 x 15	3	013082	12-3/8 x 15	3	325030		
14-17' - AL, SK	12-1/4 R 15	3	SS		013010								
13-15' - AL, SK	10.7 R 16.4	3	AL	353-64108-0	142008								
13-15' - AL, SK	11-3/4 R 17	3	SS		013026	11-3/4 x 17	3	013083	12 x 17	3	325031		
12-14' - AL, SK	10.9 R 17.6	3	AL	353-64109-0	142009								
12-14' - AL, SK	11-1/4 R 19	3	SS		013032	11-3/4 x 19	3	013084					

Rubber Hub Bushing



Boat Length/Description	VORTEX <sup>XHS</sup> PERFORMANCE PROPELLERS												
	Dia., Rot., Pitch	Bld#	Mat'l	OEM	Part No.								
	12 R 8	4	AL		992401								
	12 R 9	4	AL		992402								
	12 R 10	4	AL		992403								
15-18' - AL, SK	12 R 13	3	AL	35364-1050M	992301								
14-17' - AL, SK	12 R 15	3	AL	35364-1070M	992302								
13-15' - AL, SK	12 R 17	3	AL	35364-1090M	992303								

Use XHS™ Hub Kit 112

"NEW" VORTEX™ - AVAILABLE SPRING OF 2004 SEASON.

## 90-140 HORSEPOWER

### Thru Hub Exhaust & 15 Tooth Spline

90 HP .....1987 & Newer      120 HP .....1988 & Newer      140 HP .....1988 & Newer  
 115 HP .....1992 & Newer

Boat Length/Description	VORTEX <sup>XHS</sup> PERFORMANCE PROPELLERS						RAPTURE <sup>XHS</sup>			Use XHS™ Hub Kit 109			
	Dia., Rot., Pitch	Bld#	Mat'l	OEM	Part No.	Dia. x Pitch	Bld#	RH	LH	Use Gearcase Adapter Ring supplied with propeller.			
19-22' - RB, SK	13-3/4 R 15	3	AL		992103	13-1/4 x 15	3	993103					
18-21' - RB, SK	13-1/4 R 17	3	AL		992104	13-1/4 x 17	3	993104					
17-20' - RB, SK	13 R 19	3	AL		992105	13-1/4 x 19	3	993105					
15-18' - RB, SK	12-3/4 R 21	3	AL		992106	13-1/4 x 21	3	993106					

Boat Length/Description	MICHIGAN MATCH REPLACEMENT PROPELLERS						RAPTURE			BALLISTIC STAINLESS STEEL PROPS			
	Dia., Rot., Pitch	Bld#	Mat'l	OEM	Part No.	Dia. x Pitch	Bld#	Part No.	Dia. x Pitch	Bld#	RH	LH	
20-24' - AL, SK	13.5 R 14.6	3	AL	3B7-64532-0	142010								
20-24' - AL, SK	13-3/4 R 15	3	SS		103025				13-5/8 x 15	3	335930		
17-19' - AL, SK	13.5 R 15.7	3	AL	3B7-64536-0	142011								
17-19' - AL, SK	13-1/4 R 17	3	SS		103026				13-1/2 x 17	3	335931		
16-18' - AL, SK	12.9 R 17.6	3	AL	3B7-64541-0	142012								
16-18' - AL, SK	13 R 19	3	SS		103027				13-3/8 x 19	3	335932		
15-18' - AL, SK	12.6 R 19.9	3	AL	3B7-64545-0	142013								
15-18' - AL, SK									13-1/8 x 21	3	335933		

Rubber Hub Bushing

## 9.9-15 HORSEPOWER Thru Hub Exhaust & 10 Tooth Spline

DT 9.9 .....1983-87      DT 15 .....1983-88      DT 15(4-Stroke) .....1997 & Newer  
 DF 9.9 (4-Stroke) .....1997 & Newer      DT 15C .....1989-97

Boat Length/Description	MICHIGAN MATCH REPLACEMENT PROPELLERS						Part No.	Rubber Hub Bushing
	Dia., Rot., Pitch	Bld#	Mat'l	OEM	Part No.			
14-20' - AL	9-1/4 R 7	3	AL	58100-93703-019	<b>062015</b>			
14-18' - AL	9-1/4 R 9	3	AL	58100-93723-019	<b>062016</b>			
14-16' - AL	9-1/4 R 11	3	AL	58100-93743-019	<b>062017</b>			

## 25-30 HORSEPOWER Thru Hub Exhaust & 10 Tooth Spline

DT 25C .....1989 & Newer      DT 30, 30C .....1987-97      DF 25 (4-Stroke) .....2000 & Newer  
 DT 20, 25 .....1987-88      DT 30 @ .....1983-86      DF 30 (4-Stroke) .....2000 & Newer  
 DT 20, 25 @ .....1983-86

Boat Length/Description	MICHIGAN MATCH REPLACEMENT PROPELLERS						BALLISTIC™ STAINLESS STEEL PROPS				Rubber Hub Bushing
	Dia., Rot., Pitch	Bld#	Mat'l	OEM	Part No.	Dia. x Pitch	Bld#	RH	LH		
16-18' - AL	10-1/4 R 11	3	AL	58100-96420-019	<b>062012</b>						
16-18' - AL	10-1/4 R 11	3	AL		<b>★061006</b>						
14-16' - AL	10-1/4 R 12	3	AL	58100-96430-019	<b>062013</b>						
14-16' - AL	10-1/4 R 13	3	AL	58100-96440-019	<b>062014</b>	10-1/8 x 13	3	<b>305529</b>			
						10-1/8 x 15	3	<b>305530</b>			



Boat Length/Description	VORTEX XHS™ PERFORMANCE PROPELLERS						Part No.	Use XHS™ Hub Kit 121
	Dia., Rot., Pitch	Bld#	Mat'l	OEM	Part No.			
	10-1/4 R 9	3	AL		<b>992501</b>			
	10-1/4 R 10	3	AL	58100-96410-019	<b>992502</b>			
16-18' - AL	10-1/4 R 11	3	AL	58100-96420-019	<b>992503</b>			
14-16' - AL	10-1/8 R 12	3	AL	58100-96430-019	<b>992504</b>			
14-16' - AL	10-1/8 R 13	3	AL	58100-96440-019	<b>992505</b>			
	10-1/8 R 14	3	AL	58100-95D00-019	<b>992506</b>			

"NEW" VORTEX™ - AVAILABLE SPRING OF 2004 SEASON.

Key to abbreviations: AL: All Loads; CR: Cruisers; HB: Houseboat; HL: Heavy Loads; LL: Light Loads; RB: Runabouts; SB: Sailboat; SK: Skiboat; WB: Workboat; WD: Weedless

@ Use stopper 57632-96400

★ Indicates a cupped propeller.

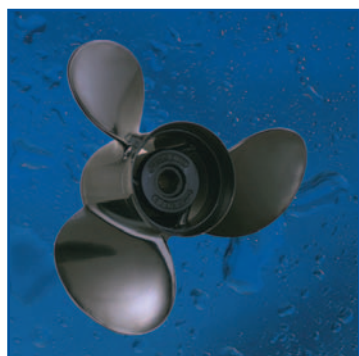

## 35-65 HORSEPOWER Thru Hub Exhaust & 13 Tooth Spline

DT 35C .....1987-90	DT 55 .....1987-90	DF 40 (4-Stroke) .....1999 & Newer
DT 40 .....1983 & Newer	DT 60 .....1983-84	DF 50 (4-Stroke) .....1999 & Newer
DT 50 & 50M .....1983-84	DT 65 .....1985-97	

Boat Length/Description	MICHIGAN MATCH REPLACEMENT PROPELLERS						RAPTURE			BALLISTIC™ STAINLESS STEEL PROPS				Rubber Hub Bushing
	Dia., Rot., Pitch	Bld#	Mat'l	OEM	Part No.	Dia. x Pitch	Bld#	Part No.	Dia. x Pitch	Bld#	RH	LH		
18-21' - AL	12-1/4 R 10	3	AL	58100-95212-019	032045	10-1/2 x 10	3	033093						
18-21' - AL	12-1/4 R 10	3	AL		*031072									
17-19' - AL	12 R 11	3	AL	58100-95222-019	032044									
17-19' - AL	12 R 11	3	AL		*031073									
16-18' - LL	10-5/8 R 12	3	SS		113001	10-1/2 x 12	3	033094						
15-17' - LL	11-3/4 R 12	3	AL	58100-95393-019	032043									
14-16' - LL	11-1/2 R 13	3	AL	58100-94313-019	032042	10-1/2 x 13	3	033095	10-1/8 x 13	3	395929			
12-14' - LL	11-1/4 R 14	3	AL	58100-95353-019	032041	10-1/2 x 14	3	033096						
12-14' - LL	11 R 15	3	AL	58100-95363-019	032040	10-1/2 x 15	3	033097	10-1/8 x 15	3	395930			
12-14' - LL	10-3/4 R 16	3	AL	58100-95373-019	032039									

**NEW**

Boat Length/Description	VORTEX™ PERFORMANCE PROPELLERS						RAPTURE™ XHS			Use XHS™ Hub Kit <b>115</b>			
	Dia., Rot., Pitch	Bld#	Mat'l	OEM	Part No.	Dia. x Pitch	Bld#	Part No.	Dia. x Pitch	Bld#	RH	LH	
	12 R 8	4	AL		992401								
	12 R 9	4	AL		992402								
18-21' - AL	12 R 10	4	AL	58100-95212-019	992403								
17-19' - AL	10-3/8 R 11	3	AL	58100-95222-019	992404								
16-18' - LL	10-3/8 R 12	3	AL	58100-95393-019	992405								
14-16' - LL	10-3/8 R 13	3	AL	58100-94313-019	992406								
12-14' - LL	10 R 14	3	AL	58100-95353-019	992407								
12-14' - LL	10 R 15	3	AL	58100-95363-019	992408								
12-14' - LL	10 R 16	3	AL	58100-95373-019	992409								

"NEW" VORTEX™ - AVAILABLE SPRING OF 2004 SEASON.

## 60-140 HORSEPOWER Thru Hub Exhaust & 13 Tooth Spline

DF60, 70 + (4-Stroke) .....1998 & Newer	DT 85 ++ .....1992 & Newer	DT 100 + .....1989 & Newer
DT 75 ++ .....1992-97	DT 85 # .....1979-91	DT 115, 140 ++ .....1992 & Newer
DT 75 # .....1983-91	DT 90 + .....1989-97	DT 115, 140 # .....1981-91

Boat Length/Description	VORTEX™ PERFORMANCE PROPELLERS						RAPTURE™ XHS			Use XHS™ Hub Kit <b>110</b>			
	Dia., Rot., Pitch	Bld#	Mat'l	OEM	Part No.	Dia. x Pitch	Bld#	RH	LH	Do NOT use Gearcase Adapter Ring supplied with propeller.			
19-22' - RB, SK	13-3/4 R 15	3	AL	58100-95500-019	992103	13-1/4 x 15	3	993103					
18-21' - RB, SK	13-1/4 R 17	3	AL	58100-95511-019	992104	13-1/4 x 17	3	993104					
17-20' - RB, SK	13 R 19	3	AL	99105-00100-16P	992105	13-1/4 x 19	3	993105					
15-18' - RB, SK	12-3/4 R 21	3	AL	58100-95530-019	992106	13-1/4 x 21	3	993106					

Boat Length/Description	MICHIGAN MATCH REPLACEMENT PROPELLERS						RAPTURE™ XHS			BALLISTIC™ STAINLESS STEEL PROPS				Rubber Hub Bushing
	Dia., Rot., Pitch	Bld#	Mat'l	OEM	Part No.	Dia. x Pitch	Bld#	RH	LH	Dia. x Pitch	Bld#	RH	LH	
17-19' - AL, SK	13-3/4 R 15	3	AL	58100-95500-019	*061001	13-5/8 x 15	3	335530						
15-18' - AL, SK	13-1/4 R 17	3	AL	58100-95511-019	*061002	13-1/2 x 17	3	335531						
17-19' - AL, SK	13-3/4 R 15	3	SS	99105-00100-16P	1063001									
14-16' - AL, SK	13 R 19	3	AL	58100-95521-019	*061003	13-3/8 x 19	3	335532						
14-16' - LL	13 R 21	3	AL	58100-95530-019	*061004	13-1/8 x 21	3	335533						
High Performance						13-1/2 x 22	3	335534 (XL)						
High Performance						13-1/2 x 24	3	335535 (XL)						



Key to abbreviations: AL: All Loads; CR: Cruisers; HB: Houseboat; HL: Heavy Loads; LL: Light Loads; RB: Runabouts; SB: Sailboat; SK: Skiboat; WB: Workboat; WD: Weedless



- \* Indicates a cupped propeller.
  - \* If currently using uncupped propeller, use cupped propeller having 2" less pitch. Boats with power trim use same pitch.
  - + Use stopper 57632-87E10, spacer 57633-95501, washer 09160-18028. ++ Use stopper 57635-95510, spacer 57633-95501, washer 09160-18028.
  - # Requires stopper 57635-95503, spacer 57633-95501, lock washer 09160-18028 (supplied with engine).
- ▶ LIMITED INVENTORY ITEMS.

**90-140 HORSEPOWER (4-STROKE)**

Thru Hub Exhaust & 15 Tooth Spline

DF 90 (4-Stroke) .....2001 & Newer      DF 115 (4-Stroke) .....2001 & Newer      DF 140 (4-Stroke) .....2002 & Newer



Boat Length/Description											Use XHS™ Hub Kit <b>103</b>
	Dia., Rot., Pitch	Bld#	Mat'l	OEM	Part No.	Dia. x Pitch	Bld#	RH	LH		
19-22' - RB, SK	13-3/4 R 15	3	AL		992103	13-1/4 x 15	3	993103			
18-21' - RB, SK	13-1/4 R 17	3	AL	58100-90J00-019	992104	13-1/4 x 17	3	993104			
17-20' - RB, SK	13 R 19	3	AL	58100-90J10-019	992105	13-1/4 x 19	3	993105			
15-18' - RB, SK	12-3/4 R 21	3	AL	58100-90J20-019	992106	13-1/4 x 21	3	993106			



Boat Length/Description											Rubber Hub Bushing
	Dia., Rot., Pitch	Bld#	Mat'l	OEM	Part No.	Dia. x Pitch	Bld#	RH	LH		
25' - AL	14 R 11	3	AL		101036						
22' - AL	13-5/8 R 13	3	AL		101031						
20-24' - AL, SK	13-1/2 R 15	3	AL		101032	13-5/8 x 15	3	335930			
20-24' - AL, SK	13-3/4 R 15	3	SS		103025						
17-19' - AL, SK	13-1/4 R 17	3	AL	58100-90J00-019	101033	13-1/2 x 17	3	335931			
17-19' - AL, SK	13-1/4 R 17	3	SS		103026						
16-18' - AL, SK	13 R 19	3	AL	58100-90J10-019	101034	13-3/8 x 19	3	335932			
16-18' - AL, SK	13 R 19	3	SS		103027						
15-18' - AL, SK	12-5/8 R 21	3	AL	58100-90J20-019	101035	13-1/8 x 21	3	335933			
High Performance						13-1/2 x 22	3	335934 (XL)			
High Performance						13-1/2 x 24	3	335935 (XL)			

**150-225 HORSEPOWER**

Thru Hub Exhaust & 15 Tooth Spline

DT 150 .....1986 & Newer      DT 200 .....1986 & Newer      DT 225 .....1990 & Newer  
DT 175 .....1986-92

Boat Length/Description											Use XHS™ Hub Kit <b>104</b>
	Dia., Rot., Pitch	Bld#	Mat'l	OEM	Part No.	Dia. x Pitch	Bld#	RH	LH		
	15-1/4 R 15	3	AL		992002	14-1/4 x 15	3	993002	993012		
	15 R 17	3	AL		992003	14-1/4 x 17	3	993003	993013		
	14-1/2 R 19	3	AL		992004	14-1/4 x 19	3	993004	993014		
	14-1/4 R 21	3	AL		992005	14-1/4 x 21	3	993005	993015		
	14 R 23	3	AL		992006	14-1/4 x 23	3	993006	993016		
						14-1/4 x 25	3	993007	993017		
	15 R 16	4	AL		992202						
	14-1/2 R 18	4	AL		992203						
	14 R 20	4	AL		992204						

Boat Length/Description											Rubber Hub Bushing
	Dia., Rot., Pitch	Bld#	Mat'l	OEM	Part No.	Dia. x Pitch	Bld#	RH	LH		
17-19' - AL, SK						14-7/8 x 15	3	345531			
15-18' - AL, SK						14-3/4 x 17	3	345532	345562		
14-16' - AL, SK						14-1/2 x 19	3	345533	345563		
14-16' - LL						14-3/8 x 21	3	345534	345564		
12-14' - LL						14-1/4 x 23	3	345535	345565		
12-14' - LL						14-1/4 x 25	3	345536			
High Performance						14-1/2 x 22	3	345541 (XL)			
High Performance						14-1/2 x 24	3	345537 (XL)			
High Performance						14-1/2 x 26	3	345538 (XL)			
<b>High Performance 4 Blade Propellers</b>											
High Performance						13-3/4 x 23	4	435535 (XL)			
High Performance						13-3/4 x 25	4	435536 (XL)			
High Performance						13-3/4 x 27	4	435537 (XL)			

Key to abbreviations: AL: All Loads; CR: Cruisers; HB: Houseboat; HL: Heavy Loads; LL: Light Loads; RB: Runabouts; SB: Sailboat; SK: Skiboat; WB: Workboat; WD: Weedless



**6-8 HORSEPOWER**

**Thru Hub Exhaust & 7 Tooth Spline**

6 HP .....1986 & Newer      8 HP .....1986 & Newer

Boat Length/Description							Part No.	Rubber Hub Bushing
	Dia., Rot., Pitch	Bld#	Mat'l	OEM	Part No.			
General Usage	8-1/2 R 6-1/2	3	AL	6G1-45947-00-EL	<b>102001</b>			
General Usage	8-1/2 R 7-1/2	3	AL	6G1-45943-00-EL	<b>102002</b>			

**8 HORSEPOWER**

**Non-Thru Hub Exhaust & Pin Drive**

8 HP .....1976-83

Boat Length/Description							Part No.	Rubber Hub Bushing
	Dia., Rot., Pitch	Bld#	Mat'l	OEM	Part No.			
14-16' - AL	8-1/4 R 8	3	AL		<b>012008</b>			
14-16' - AL	8-1/4 R 9	3	AL		<b>012101</b>			

**9.9-15 HORSEPOWER**

**Thru Hub Exhaust & 8 Tooth Spline**

9.9 HP .....1984 & Newer      15 HP .....1984 & Newer

Boat Length/Description							Part No.	Rubber Hub Bushing
	Dia., Rot., Pitch	Bld#	Mat'l	OEM	Part No.			
13-17' - HL	9-1/4 R 8	3	AL	683-45947-00-EL	<b>102003</b>			
12-15' - AL	9-1/4 R 9	3	AL	683-45945-00-EL	<b>102004</b>			
12-15' - AL	9-1/4 R 10-1/2	3	AL	683-45943-00-EL	<b>102005</b>			

**15-28 HORSEPOWER**

**Non-Thru Hub Exhaust & Pin Drive**

15A & W15 HP .....1976-83      25 HP 2 Cyl. ....1977-79      28 HP .....1976-78  
 20 HP .....1976-78

Boat Length/Description							Part No.	Rubber Hub Bushing
	Dia., Rot., Pitch	Bld#	Mat'l	OEM	Part No.			
HB, SB	9-1/4 R 7	3	AL	650-45943-01-36	<b>012102</b>			
12-14' - HL	9 R 10	3	AL	651-45947-00-36	<b>012011</b>			
12-14' - AL	9-1/4 R 11	3	AL	653-45941-01-36	<b>012013</b>			
12-14' - LL	9-1/4 R 12	3	AL		<b>012010</b>			

Key to abbreviations: AL: All Loads; CR: Cruisers; HB: Houseboat; HL: Heavy Loads; LL: Light Loads; RB: Runabouts; SB: Sailboat; SK: Skiboat; WB: Workboat; WD: Weedless

## 20-30 HORSEPOWER Thru Hub Exhaust & 10 Tooth Spline

20 HP .....1996-97                      25 HP (4-Stroke) .....2001                      30 HP .....1979 & Newer  
 25 HP .....1980 & Newer                      30 HP (4-Stroke) .....2001

Boat Length/Description	MICHIGAN MATCH REPLACEMENT PROPELLERS						BALLISTIC STAINLESS STEEL PROPS					Rubber Hub Bushing
	Dia., Rot., Pitch	Bld#	Mat'l	OEM	Part No.	Dia. x Pitch	Bld#	RH	LH			
16-18' - AL, SK	9-7/8 R 9	3	AL	664-45941-01-EL	<b>022001</b>							
16-18' - AL, SK	9-7/8 R 9	3	AL		★021001							
14-17' - AL, SK	9-7/8 R 10-1/2	3	AL	664-45945-00-EL	<b>022002</b>							
13-16' - LL	9-3/8 R 12	3	AL	664-45954-00-EL	<b>022003</b>							
14-17' - General Us.						10-1/8 x 13	3	<b>305929</b>				
13-15' - General Us.						10-1/8 x 15	3	<b>305930</b>				



Boat Length/Description	VORTEX XHS™ PERFORMANCE PROPELLERS						Use XHS™ Hub Kit 123
	Dia., Rot., Pitch	Bld#	Mat'l	OEM	Part No.		
16-18' - AL, SK	10-1/4 R 9	3	AL	664-45941-01-EL	<b>992501</b>		
14-17' - AL, SK	10-1/4 R 10	3	AL	664-45945-00-EL	<b>992502</b>		
14-17' - AL, SK	10-1/4 R 11	3	AL	664-45947-01-EL	<b>992503</b>		
13-16' - LL	10-1/8 R 12	3	AL	664-45954-00-EL	<b>992504</b>		
14-17'	10-1/8 R 13	3	AL	664-45949-02-EL	<b>992505</b>		
13-15'	10-1/8 R 14	3	AL	664-45952-00-EL	<b>992503</b>		

"NEW" VORTEX™ - AVAILABLE SPRING OF 2004 SEASON.

## 40-60 HORSEPOWER Thru Hub Exhaust & 13 Tooth Spline

40 HP .....1984 & Newer                      55 HP .....1976-95                      FS 40 (4-Stroke) .....1999 & Newer  
 48 HP .....1995 & Newer                      60 HP .....1976-91                      FS 50 (4-Stroke) .....1995 & Newer  
 50 HP (not T50) .....1984 & Newer

Boat Length/Description	MICHIGAN MATCH REPLACEMENT PROPELLERS						RAPTURE			BALLISTIC STAINLESS STEEL PROPS				Rubber Hub Bushing
	Dia., Rot., Pitch	Bld#	Mat'l	OEM	Part No.	Dia. x Pitch	Bld#	Part No.	Dia. x Pitch	Bld#	RH	LH		
19-22' - LL	12-1/4 R 10	3	AL		<b>032045</b>									
19-22' - LL	12-1/4 R 10	3	AL		★031072	10-1/2 x 10	3	<b>033093</b>						
17-19' - AL, SK	12 R 11	3	AL	663-45947-02-EL	<b>032044</b>									
17-19' - AL, SK	12 R 11	3	AL		★031073									
15-18' - AL, SK	10-5/8 R 12	3	SS		▶113001									
16-17' - AL, SK	11-3/4 R 12	3	AL	6H5-45952-00-EL	<b>032043</b>	10-1/2 x 12	3	<b>033094</b>						
14-16' - AL, SK	11-1/2 R 13	3	AL	6H5-45945-00-EL	<b>032042</b>	10-1/2 x 13	3	<b>033095</b>	10-1/8 x 13	3	<b>395929</b>			
12-14' - LL	11-1/4 R 14	3	AL	663-45958-01-EL	<b>032041</b>	10-1/2 x 14	3	<b>033096</b>						
12-14' - LL	11 R 15	3	AL	6H5-45943-00-EL	<b>032040</b>	10-1/2 x 15	3	<b>033097</b>	10-1/8 x 15	3	<b>395930</b>			
12-14' - LL	10-3/4 R 16	3	AL	663-45949-01-EL	<b>032039</b>									



Boat Length/Description	VORTEX XHS™ PERFORMANCE PROPELLERS						Use XHS™ Hub Kit 117
	Dia., Rot., Pitch	Bld#	Mat'l	OEM	Part No.		
	12 R 8	4	AL		<b>992401</b>		
	12 R 9	4	AL		<b>992402</b>		
19-22' - LL	12 R 10	4	AL		<b>992403</b>		
17-19' - AL, SK	10-3/8 R 11	3	AL	663-45947-02-EL	<b>992404</b>		
16-17' - AL, SK	10-3/8 R 12	3	AL	6H5-45952-00-EL	<b>992405</b>		
14-16' - AL, SK	10-3/8 R 13	3	AL	6H5-45945-00-EL	<b>992406</b>		
12-14' - LL	10 R 14	3	AL	6H5-45958-00-EL	<b>992407</b>		
12-14' - LL	10 R 15	3	AL	6H5-45943-00-EL	<b>992408</b>		
12-14' - LL	10 R 16	3	AL	663-45949-01-EL	<b>992409</b>		



"NEW" VORTEX™ - AVAILABLE SPRING OF 2004 SEASON.



Key to abbreviations: AL: All Loads; CR: Cruisers; HB: Houseboat; HL: Heavy Loads; LL: Light Loads; RB: Runabouts; SB: Sailboat; SK: Skiboat; WB: Workboat; WD: Weedless

★ Indicates a cupped propeller.                      ▶ LIMITED INVENTORY ITEMS.

## 50-100 HORSEPOWER Thru Hub Exhaust & 15 Tooth Spline



T50 HP .....1996 & Newer	75 HP .....1994 & Newer	90 HP .....1984 & Newer
60 HP .....1992 & Newer	80 HP .....1997	FS 80 (4-Stroke) .....1999 & Newer
70 HP .....1984 & Newer	85 HP .....1991-97	FS 100 (4-Stroke) .....1999 & Newer



Boat Length/Description											Use XHS™ Hub Kit <b>108</b> Use Gearcase Adapter Ring supplied with propeller.
	Dia., Rot., Pitch	Bld#	Mat'l	OEM	Part No.	Dia. x Pitch	Bld#	RH	LH		
19-22' - RB, SK	13-3/4 R 15	3	AL	6E5-45947-00-EL	<b>992103</b>	13-1/4 x 15	3	<b>993103</b>			
18-21' - RB, SK	13-1/4 R 17	3	AL	6E5-45945-01-EL	<b>992104</b>	13-1/4 x 17	3	<b>993104</b>			
17-20' - RB, SK	13 R 19	3	AL	6E5-45941-00-EL	<b>992105</b>	13-1/4 x 19	3	<b>993105</b>			
15-18' - RB, SK	12-3/4 R 21	3	AL	6E5-45943-00-EL	<b>992106</b>	13-1/4 x 21	3	<b>993106</b>			

Boat Length/Description											Rubber Hub Bushing
	Dia., Rot., Pitch	Bld#	Mat'l	OEM	Part No.	Dia. x Pitch	Bld#	RH	LH		
25' - AL	14 R 11	3	AL	6E5-45954-00-EL	<b>101036</b>						
22' - AL	13-5/8 R 13	3	AL	6E5-45949-00-EL	<b>101031</b>						
20-24' - AL, SK	13-1/2 R 15	3	AL	6E5-45947-00-EL	<b>101032</b>	13-5/8 x 15	3	<b>335930</b>			
20-24' - AL, SK	13-3/4 R 15	3	SS	688-45978-60-98	<b>103025</b>						
17-19' - AL, SK	13-1/4 R 17	3	AL	6E5-45945-01-EL	<b>101033</b>	13-1/2 x 17	3	<b>335931</b>			
17-19' - AL, SK	13-1/4 R 17	3	SS	688-45930-02-98	<b>103026</b>						
16-18' - AL, SK	13 R 19	3	AL	6E5-45941-00-EL	<b>101034</b>	13-3/8 x 19	3	<b>335932</b>			
16-18' - AL, SK	13 R 19	3	SS	688-45970-03-98	<b>103027</b>						
15-18' - AL, SK	12-5/8 R 21	3	AL	6E5-45943-00-EL	<b>101035</b>	13-1/8 x 21	3	<b>335933</b>			
High Performance						13-1/2 x 22	3	<b>335934 (XL)</b>			
High Performance						13-1/2 x 24	3	<b>335935 (XL)</b>			

## 115-130 HORSEPOWER Thru Hub Exhaust & 15 Tooth Spline

115 HP .....1984 & Newer	FS115 (4-Stroke) .....2000 & Newer	130 HP .....1984 & Newer
--------------------------	------------------------------------	--------------------------

Boat Length/Description											Use XHS™ Hub Kit <b>103</b> Use Gearcase Adapter Ring supplied with propeller.
	Dia., Rot., Pitch	Bld#	Mat'l	OEM	Part No.	Dia. x Pitch	Bld#	RH	LH		
19-22' - RB, SK	13-3/4 R 15	3	AL	6E5-45947-00-EL	<b>992103</b>	13-1/4 x 15	3	<b>993103</b>			
18-21' - RB, SK	13-1/4 R 17	3	AL	6E5-45945-01-EL	<b>992104</b>	13-1/4 x 17	3	<b>993104</b>			
17-20' - RB, SK	13 R 19	3	AL	6E5-45941-00-EL	<b>992105</b>	13-1/4 x 19	3	<b>993105</b>			
15-18' - RB, SK	12-3/4 R 21	3	AL	6E5-45943-00-EL	<b>992106</b>	13-1/4 x 21	3	<b>993106</b>			



Boat Length/Description											Rubber Hub Bushing
	Dia., Rot., Pitch	Bld#	Mat'l	OEM	Part No.	Dia. x Pitch	Bld#	RH	LH		
25' - AL	14 R 11	3	AL	6E5-45954-00-EL	<b>101036</b>						
22' - AL	13-5/8 R 13	3	AL	6E5-45949-00-EL	<b>101031</b>						
20-24' - AL, SK	13-1/2 R 15	3	AL	6E5-45947-00-EL	<b>101032</b>	13-5/8 x 15	3	<b>335930</b>			
20-24' - AL, SK	13-3/4 R 15	3	SS	688-45978-60-98	<b>103025</b>						
17-19' - AL, SK	13-1/4 R 17	3	AL	6E5-45945-01-EL	<b>101033</b>	13-1/2 x 17	3	<b>335931</b>			
17-19' - AL, SK	13-1/4 R 17	3	SS	688-45930-02-98	<b>103026</b>						
16-18' - AL, SK	13 R 19	3	AL	6E5-45941-00-EL	<b>101034</b>	13-3/8 x 19	3	<b>335932</b>			
16-18' - AL, SK	13 R 19	3	SS	688-45970-03-98	<b>103027</b>						
15-18' - AL, SK	12-5/8 R 21	3	AL	6E5-45943-00-EL	<b>101035</b>	13-1/8 x 21	3	<b>335933</b>			
High Performance						13-1/2 x 22	3	<b>335934 (XL)</b>			
High Performance						13-1/2 x 24	3	<b>335935 (XL)</b>			



Key to abbreviations: AL: All Loads; CR: Cruisers; HB: Houseboat; HL: Heavy Loads; LL: Light Loads; RB: Runabouts; SB: Sailboat; SK: Skiboat; WB: Workboat; WD: Weedless

## 80-140 HORSEPOWER

### Thru Hub Exhaust & 15 Tooth Spline

80, 90, 115 HP .....1978-83      80 HP .....1977 See Mercury section on page 20 for available propellers.  
 140 HP .....1978-79



Boat Length/Description											Use XHS™ Hub Kit <b>102</b> Use Gearcase Adapter Ring supplied with propeller.
	Dia., Rot., Pitch	Bld#	Mat'l	OEM	Part No.	Dia. x Pitch	Bld#	RH	LH		
19-22' - RB, SK	13-3/4 R 15	3	AL		992103	13-1/4 x 15	3	993103			
18-21' - RB, SK	13-1/4 R 17	3	AL		992104	13-1/4 x 17	3	993104			
17-20' - RB, SK	13 R 19	3	AL		992105	13-1/4 x 19	3	993105			
15-18' - RB, SK	12-3/4 R 21	3	AL		992106	13-1/4 x 21	3	993106			



Boat Length/Description											Rubber Hub Bushing
	Dia., Rot., Pitch	Bld#	Mat'l	OEM	Part No.	Dia. x Pitch	Bld#	RH	LH		
25' & Up - AL	14 R 11	3	AL		031054						
22' & Up - AL	14 R 13	3	AL		031055						
20-24' - AL, SK	13-3/4 R 15	3	AL		031041	13-5/8 x 15	3	335130			
20-24' - AL, SK	13-3/4 R 15	3	SS		033016						
17-19' - AL, SK	13-1/4 R 17	3	AL		031042	13-1/2 x 17	3	335131			
17-19' - AL, SK	13-1/4 R 17	3	SS		033017						
16-18' - AL, SK	13 R 19	3	AL		031043	13-3/8 x 19	3	335132			
16-18' - AL, SK	13 R 19	3	SS		033018						
15-18' - AL, SK	12-3/4 R 21	3	AL		031044	13-1/8 x 21	3	335133			
15-18' - AL, SK	13 R 21	3	SS		033019						
14-16' - AL, SK	12-1/2 R 23	3	AL		031045						
High Performance						13-1/2 x 22	3	335134 (XL)			
High Performance						13-1/2 x 24	3	335135 (XL)			

## 150-175 HORSEPOWER

### Thru Hub Exhaust & 15 Tooth Spline

150 HP .....1979-83      175 HP .....1978-79      175 HP (DI & VMAX) .....2001



Boat Length/Description											Use XHS™ Hub Kit <b>102</b>
	Dia., Rot., Pitch	Bld#	Mat'l	OEM	Part No.	Dia. x Pitch	Bld#	RH	LH		
20-22' - AL, SK	15-1/4 R 15	3	AL		992002	14-1/4 x 15	3	993002	993012		
19-21' - AL, SK	15 R 17	3	AL		992003	14-1/4 x 17	3	993003	993013		
18-20' - AL, SK	14-1/2 R 19	3	AL		992004	14-1/4 x 19	3	993004	993014		
18-19' - AL, SK	14-1/4 R 21	3	AL		992005	14-1/4 x 21	3	993005	993015		
17-19' - AL, SK	14 R 23	3	AL		992006	14-1/4 x 23	3	993006	993016		
17-18' - AL, SK						14-1/4 x 25	3	993007	993017		
21-25' - AL, SK	15 R 16	4	AL		992202						
19-23' - AL, SK	14-1/2 R 18	4	AL		992203						
18-22' - AL, SK	14 R 20	4	AL		992204						

Boat Length/Description											Rubber Hub Bushing
	Dia., Rot., Pitch	Bld#	Mat'l	OEM	Part No.	Dia. x Pitch	Bld#	RH	LH		
CR, HB	16 R 11	3	AL		031021						
CR, HB	16 R 13	3	AL		031022						
20-24' - AL, SK	15-1/4 R 15	3	AL		031023	14-7/8 x 15	3	345131			
20-22' - AL, SK	14-1/2 R 15	3	SS		033002						
19-21' - AL, SK	14-1/2 R 17	3	AL		031024	14-3/4 x 17	3	345132	345162		
19-21' - AL, SK	14-1/2 R 17	3	SS		033003						
18-20' - AL, SK	14 R 19	3	AL		031025	14-1/2 x 19	3	345133	345163		
18-20' - AL, SK	14 R 19	3	SS		033004						
18-19' - AL, SK	13-3/4 R 21	3	AL		031026	14-3/8 x 21	3	345134	345164		
18-19' - AL, SK	13-3/4 R 21	3	SS		033005						
17-19' - AL, SK	13-1/2 R 23	3	AL		031027	14-1/4 x 23	3	345135	345165		
17-19' - AL, SK	13-1/2 R 23	3	SS		033006						
17-18' - AL, SK	13-3/8 R 25	3	AL		031067	14-1/4 x 25	3	345136			



Key to abbreviations: AL: All Loads; CR: Cruisers; HB: Houseboat; HL: Heavy Loads; LL: Light Loads; RB: Runabouts; SB: Sailboat; SK: Skiboat; WB: Workboat; WD: Weedless

## 150-250 HORSEPOWER Thru Hub Exhaust & 15 Tooth Spline

150 HP .....1986 & Newer	220 HP (Special) .....1984-85	250 HP (VMAX) .....2001
175 HP .....1984 & Newer	225 HP (Excel) .....1987-88	F200 (4-Stroke) .....2002 & Newer
200 HP .....1984 & Newer	225 HP .....1986 & Newer	F225 (4-Stroke) .....2002 & Newer
200 HP (VMAX) .....2001	250 HP .....1990 & Newer	

Boat Length/Description										
	Dia., Rot., Pitch	Bld#	Mat'l	OEM	Part No.	Dia. x Pitch	Bld#	RH	LH	
20-22' - AL, SK	15-1/4 R 15	3	AL	6G5-45941-00-98	<b>992002</b>	14-1/4 x 15	3	<b>993002</b>	<b>993012</b>	
19-21' - AL, SK	15 R 17	3	AL	6G5-45947-01-98	<b>992003</b>	14-1/4 x 17	3	<b>993003</b>	<b>993013</b>	
18-20' - AL, SK	14-1/2 R 19	3	AL	6G5-45945-01-98	<b>992004</b>	14-1/4 x 19	3	<b>993004</b>	<b>993014</b>	
18-19' - AL, SK	14-1/4 R 21	3	AL	6H5-45943-01-98	<b>992005</b>	14-1/4 x 21	3	<b>993005</b>	<b>993015</b>	
17-19' - AL, SK	14 R 23	3	AL	6G5-45949-00-98	<b>992006</b>	14-1/4 x 23	3	<b>993006</b>	<b>993016</b>	
Up to 18' - AL, SK						14-1/4 x 25	3	<b>993007</b>	<b>993017</b>	
20-21' - AL, SK	15 R 16	4	AL		<b>992202</b>					
19-23' - AL, SK	14-1/2 R 18	4	AL		<b>992203</b>					
18-22' - AL, SK	14 R 20	4	AL		<b>992204</b>					

Use XHS™  
Hub Kit  
**103**

Boat Length/Description										
	Dia., Rot., Pitch	Bld#	Mat'l	OEM	Part No.	Dia. x Pitch	Bld#	RH	LH	
20-22' - AL, SK	15-1/4 R 15	3	AL	6G5-45941-00-98	<b>101025</b>	14-7/8 x 15	3	<b>345931</b>		
20-21' - AL, SK	14-5/8 R 16	3	AL	6G5-45952-00-98	<b>101026</b>					
19-21' - AL, SK	14-1/2 R 17	3	AL	6G5-45947-01-98	<b>101027</b>	14-3/4 x 17	3	<b>345932</b>	<b>345962</b>	
19-21' - AL, SK	14-1/2 R 17	3	SS	6G5-45978-03-98	<b>▶103018</b>					
18-20' - AL, SK	14 R 19	3	AL	6G5-45945-01-98	<b>101028</b>	14-1/2 x 19	3	<b>345933</b>	<b>345963</b>	
18-20' - AL, SK	14 R 19	3	SS	6G5-45974-03-98	<b>▶103020</b>					
18-20' - AL, SK	13-3/4 R 21	3	AL	6H5-45943-01-98	<b>101029</b>	14-3/8 x 21	3	<b>345934</b>	<b>345964</b>	
18-20' - AL, SK	13-3/4 R 21	3	SS	6G5-45972-02-98	<b>▶103022</b>					
18-19" - AL, SK	13-1/2 R 23	3	AL	6G5-45949-00-98	<b>101030</b>	14-1/4 x 23	3	<b>345935</b>	<b>345965</b>	
Up to 18' - AL, SK						14-1/4 x 25	3	<b>345936</b>		
High Performance						14-1/2 x 22	3	<b>345941</b>	(XL)	
High Performance						14-1/2 x 24	3	<b>345937</b>	(XL)	
High Performance						14-1/2 x 26	3	<b>345938</b>	(XL)	
<b>High Performance 4 Blade Propellers • Thru Hub Exhaust • 15 Tooth Spline</b>										
High Performance						13-3/4 x 23	4	<b>435935</b>	(XL)	
High Performance						13-3/4 x 25	4	<b>435936</b>	(XL)	
High Performance						13-3/4 x 27	4	<b>435937</b>	(XL)	

Rubber  
Hub  
Bushing

Key to abbreviations: AL: All Loads; CR: Cruisers; HB: Houseboat; HL: Heavy Loads; LL: Light Loads; RB: Runabouts; SB: Sailboat; SK: Skiboat; WB: Workboat; WD: Weedless

▶ LIMITED INVENTORY ITEMS.



  
PERFORMANCE PROPELLERS







  
STAINLESS STEEL PROPS

# STERNDRIVE PROPELLERS

## MOTOR APPLICATION GUIDE



---





**MERCUISER™, ALPHA ONE™ • 110-190 HP**  
**Thru Hub Exhaust & 15 Tooth Spline**

SEE FOOTNOTES ■ & ▼

MODELS 1A, 1B, 1C . . . . . 120-190 HP Mercruiser™ . . . . .1983-85 3.0L (125-140 HP) Alpha One™ .1986 & Newer  
 MODELS 120, 140, 145 DTS . . . . . 2.5 L (120 HP) Alpha One™ . . . . .1986-89 3.7 L (165-190 HP) Alpha One™ .1986-89  
 MODELS 165, 228, 470, 485, 888, 898

Boat Length - (MPH)										
	Dia., Rot., Pitch	Bld#	Mat'l	OEM	Part No.	Dia. x Pitch	Bld#	RH	LH	
21-26' - (18-31)	15-1/4 R 15	3	AL		992002	14-1/4 x 15	3	993002	993012	
19-23' - (27-37)	15 R 17	3	AL		992003	14-1/4 x 17	3	993003	993013	
17-21' - (33-42)	14-1/2 R 19	3	AL		992004	14-1/4 x 19	3	993004	993014	
Up to 19' - (37-46)	14-1/4 R 21	3	AL		992005	14-1/4 x 21	3	993005	993015	
Up to 18' - (40-50)	14 R 23	3	AL		992006	14-1/4 x 23	3	993006	993016	
						14-1/4 x 25	3	993007	993017	
19-23' - (26-34)	15 R 16	4	AL		992202					
17-21' - (32-39)	14-1/2 R 18	4	AL		992203					
	14 R 20	4	AL		992204					

Use XHS™ Hub Kit  
**102**

Boat Length - (MPH)										
	Dia., Rot., Pitch	Bld#	Mat'l	OEM	Part No.	Dia. x Pitch	Bld#	RH	LH	
Non-Plane Heavy CR	16 R 11	3	AL	48-78112A40	031021					
Non-Plane Heavy CR	16 R 12	3	AL	48-16436A40	031063					
Non-Plane Heavy CR	16 R 13	3	AL	48-78114A40	031022					
21-26' - (17-28)	16 R 14	3	AL	48-16438A40	031050					
21-26' - (18-31)	15-1/4 R 15	3	AL	48-78116A40	031023	14-7/8 x 15	3	※345131		
21-26' - (18-31)	14-1/2 R 15	3	SS	48-16312A4	033002					
19-23' - (26-34)	16 R 16	3	AL	48-16440A40	031051					
19-23' - (27-37)	14-1/2 R 17	3	AL	48-78118A40	031024	14-3/4 x 17	3	※345132	※345162	
19-23' - (27-37)	14-1/2 R 17	3	SS	48-16314A4	033003					
19-23' - (27-37)	15 R 17	3	AL	48-832828A45	●031064					
17-21' - (32-39)	15-1/2 R 18	3	AL	48-11324A45	031052					
17-21' - (33-42)	14 R 19	3	AL	48-78120A40	031025	14-1/2 x 19	3	※345133	※345163	
17-21' - (33-42)	14 R 19	3	SS	48-16316A4	033004					
17-21' - (33-42)	14-1/2 R 19	3	AL	48-832830A45	●031065					
Up to 19' - (37-46)	13-3/4 R 21	3	AL	48-78122A40	031026	14-3/8 x 21	3	※345134	※345164	
Up to 19' - (37-46)	13-3/4 R 21	3	SS	48-16318A4	033005					
Up to 19' - (37-46)	14-1/4 R 21	3	AL	48-832832A45	●031066					
Up to 18' - (40-50)	13-1/2 R 23	3	AL	48-78124A40	031027	14-1/4 x 23	3	※345135	※345165	
Up to 18' - (40-50)	13-1/2 R 23	3	SS	48-16320A4	033006					
Up to 18' - (40-50)	14 R 23	3	AL	48-832834A45	●031068					
Up to 18' - (43-55)	13-3/8 R 25	3	AL	48-78126A40	031067	14-1/4 x 25	3	※345136		
16-19' High Perf.	(Lifting Hull)					14-1/2 x 22	3	※345141 (XL)		
15-18' High Perf.	(Lifting Hull)					14-1/2 x 24	3	※345137 (XL)		
Up to 17' High Perf.	(Lifting Hull)					14-1/2 x 26	3	※345138 (XL)		

Rubber Hub Bushing



Key to abbreviations: AL: All Loads; CR: Cruisers; HB: Houseboat; HL: Heavy Loads; LL: Light Loads; RB: Runabouts; SB: Sailboat; SK: Skiboat; WB: Workboat; WD: Weedless

- When replacing Flo-Torq II™ plastic hub props, aft castle thrust washer 12-31211A2 and conductivity (start) washer 13-42351-1 are required in addition to the other hardware supplied with original propeller. For complete details, see page 22. All suggestions are based upon single engine boats. Add 4" of pitch for twin applications.
- ▼ Caution: Use standard trim tab 34127A1 (except for Rapture™ and Ballistic™ use 822777A1) and forward thrust washer 13191A1.
- Larger blade area design used primarily on 1997 and newer applications.
- ※ When using Rapture™ and Ballistic™ propellers, to avoid damage or injury, replace standard trim tab with trim tab 822777A1 and use forward thrust washer 12-835467.



**MERCUISER™, ALPHA ONE™, BRAVO ONE™ • 200-320 HP**  
**Thru Hub Exhaust & 15 Tooth Spline**

SEE FOOTNOTES ■ & ▼

MODELS 225S, 233, 255TRS . . .	5.0 L (180-240 HP) Alpha One™ 1986 & Newer	6.2 MPI (320 HP) Alpha One™ . . .2001
MODELS 260, 280TRS, 330TRS .	5.7 L (210-260 HP) Alpha One™ 1986 & Newer	5.0 L (220-240 HP) Bravo One™ .1998 & Newer
200-260 HP Mercruiser™ . . . . .1983-85	262 Magnum (205 HP) Alpha One™ 1986 & Newer	5.7 L (210-280 HP) Bravo One™ .1995 & Newer
4.3 L (155-210 HP) Alpha One™ .1986 & Newer	350 Magnum (240-300 HP) . . . .1987 & Newer	350 Magnum (300 HP) Bravo One™ 1996 & Newer

Boat Length/Description										
	Dia., Rot., Pitch	Bld#	Mat'l	OEM	Part No.	Dia. x Pitch	Bld#	RH	LH	
23-28' - (19-38)	15-1/4 R 15	3	AL		992002	14-1/4 x 15	3	993002	993012	
21-26' - (29-45)	15 R 17	3	AL		992003	14-1/4 x 17	3	993003	993013	
19-25' - (35-49)	14-1/2 R 19	3	AL		992004	14-1/4 x 19	3	993004	993014	
17-23' - (41-56)	14-1/4 R 21	3	AL		992005	14-1/4 x 21	3	993005	993015	
Up to 20' - (47-62)	14 R 23	3	AL		992006	14-1/4 x 23	3	993006	993016	
						14-1/4 x 25	3	993007	993017	
22-26' - (26-35)	15 R 16	4	AL		992202					
21-25' - (34-42)	14-1/2 R 18	4	AL		992203					
	14 R 20	4	AL		992204					

Use XHS™  
 Hub Kit  
**102**

Boat Length - (MPH)										
	Dia., Rot., Pitch	Bld#	Mat'l	OEM	Part No.	Dia. x Pitch	Bld#	RH	LH	
Non-Plane Heavy CR	16 R 11	3	AL	48-78112A40	031021					
Non-Plane Heavy CR	16 R 12	3	AL	48-16436A40	031063					
HB - (18-26)	16 R 13	3	AL	48-78114A40	031022					
23-27' - (18-31)	16 R 14	3	AL	48-16438A40	031050					
23-28' - (19-38)	15-1/4 R 15	3	AL	48-78116A40	031023	14-7/8 x 15	3	※345131		
23-28' - (19-38)	14-1/2 R 15	3	SS	48-16312A4	033002					
22-26' - (26-35)	16 R 16	3	AL	48-16440A40	031051					
21-26' - (29-45)	14-1/2 R 17	3	AL	48-78118A40	031024	14-3/4 x 17	3	※345132	※345162	
21-26' - (29-45)	14-1/2 R 17	3	SS	48-16314A4	033003					
21-26' - (29-45)	15 R 17	3	AL	48-832828A45	●031064					
21-25' - (34-42)	15-1/2 R 18	3	AL	48-11324A45	031052					
19-25' - (35-49)	14 R 19	3	AL	48-78120A40	031025	14-1/2 x 19	3	※345133	※345163	
19-25' - (35-49)	14 R 19	3	SS	48-16316A4	033004					
19-25' - (35-49)	14-1/2 R 19	3	AL	48-832830A45	●031065					
17-23' - (41-56)	13-3/4 R 21	3	AL	48-78122A40	031026	14-3/8 x 21	3	※345134	※345164	
17-23' - (41-56)	13-3/4 R 21	3	SS	48-16318A4	033005					
17-23' - (41-56)	14-1/4 R 21	3	AL	48-832832A45	●031066					
Up to 20' - (47-62)	13-1/2 R 23	3	AL	48-78124A40	031027	14-1/4 x 23	3	※345135	※345165	
Up to 20' - (47-62)	13-1/2 R 23	3	SS	48-16320A4	033006					
Up to 20' - (47-62)	14 R 23	3	AL	48-832834A45	●031068					
Up to 18' - (47-65)	13-3/8 R 25	3	AL	48-78126A40	031067	14-1/4 x 25	3	※345136		
High Performance (Lifting Hull)						14-1/2 x 22	3	※345141 (XL)		
High Performance (Lifting Hull)						14-1/2 x 24	3	※345137 (XL)		
High Performance (Lifting Hull)						14-1/2 x 26	3	※345138 (XL)		

Rubber  
 Hub  
 Bushing

Key to abbreviations: AL: All Loads; CR: Cruisers; HB: Houseboat; HL: Heavy Loads; LL: Light Loads; RB: Runabouts; SB: Sailboat; SK: Skiboat; WB: Workboat; WD: Weedless

- When replacing Flo-Torq II™ plastic hub props, aft castle thrust washer 12-31211A2 and conductivity (start) washer 13-42351-1 are required in addition to the other hardware supplied with original propeller. For complete details, see page 22. All suggestions are based upon single engine boats. Add 4" of pitch for twin applications.
- ▼ Caution: Use standard trim tab 34127A1 (except for Rapture™ and Ballistic™ use 822777A1) and forward thrust washer 13191A1.
- Larger blade area design used primarily on 1997 and newer applications.
- ※ When using Rapture™ and Ballistic™ propellers, to avoid damage or injury, replace standard trim tab with trim tab 822777A1 and use forward thrust washer 12-835467.



**ALPHA ONE™ 1987 & NEWER • 365 HP & LOWER • (RUBBER HUB)** See Footnotes ■ & ▼  
**Thru Hub Exhaust & 15 Tooth Spline**

5.0 L (250 HP) . . . . .1998 & Newer	454 Magnum (330 HP) . . . . .1987	D 3.6 L (Diesel) . . . . .1990 & Newer
5.7 L (250-260 HP) . . . . .1995 & Newer	D 2.8 L (Diesel) . . . . .1997 & Newer	D 3.0 L (Diesel) . . . . .1990-96
320 EFI (320 HP) . . . . .1987-89	D 4.2 L (Diesel) . . . . .1990 & Newer	D 7.3 L (Diesel) . . . . .1998 & Newer
350 Magnum (240-280 HP) . . . . .1987 & Newer		

Boat Length/Description	MICHIGAN MATCH REPLACEMENT PROPELLERS						BALLISTIC™ STAINLESS STEEL PROPS			
	Dia., Rot., Pitch	Bld#	Mat'l	OEM	Part No.	Dia. x Pitch	Bld#	RH	LH	
23-28' - AL						14-7/8 x 15	3	☒345131		
21-26' - AL, SK						14-3/4 x 17	3	☒345132		
21-26' - AL, SK						14-3/4 x 17	3		☒345162	
22-25' - AL, SK	15-1/4 R 19	3	SS	48-13700A41	☐033030	14-1/2 x 19	3	☒345133		
22-25' - AL, SK	15-1/4 L 19	3	SS	48-13701A41	☐033029	14-1/2 x 19	3		☒345163	
21-23' - AL, SK	14-3/4 R 21	3	SS	48-13702A41	☐033032	14-3/8 x 21	3	☒345134		
21-23' - AL, SK	14-3/4 L 21	3	SS	48-13703A41	☐033031	14-3/8 x 21	3		☒345164	
Up to 22' - AL, SK	14-5/8 R 23	3	SS	48-13704A41	☐033034	14-1/4 x 23	3	☒345135		
Up to 22' - AL, SK	14-5/8 L 23	3	SS	48-13705A41	☐033033	14-1/4 x 23	3		☒345165	
Up to 20' - AL, SK	14-1/2 R 25	3	SS	48-13706A41	☐033036	14-1/4 x 25	3	☒345136		
Up to 20' - AL, SK	14-1/2 L 25	3	SS	48-13707A41	☐033035					

Rubber Hub Bushing

**BRAVO ONE™ 1988 & NEWER • 365 HP & LOWER • (RUBBER HUB)** See Footnotes ■ & ▼  
**Thru Hub Exhaust & 15 Tooth Spline**

5.7 L (250-280 HP) . . . . .1995 & Newer	350 Magnum (300 HP) . . . . .1996 & Newer	7.4 L (300-330 HP) . . . . .1988 & Newer
320 EFI (320 HP) . . . . .1988-89	454 Magnum (350-365 HP) . . . . .1988 & Newer	

Boat Length/Description	MICHIGAN MATCH REPLACEMENT PROPELLERS						BALLISTIC™ STAINLESS STEEL PROPS			
	Dia., Rot., Pitch	Bld#	Mat'l	OEM	Part No.	Dia. x Pitch	Bld#	RH	LH	
23-28' - AL						14-7/8 x 15	3	☒345131		
21-26' - AL, SK						14-3/4 x 17	3	☒345132		
21-26' - AL, SK						14-3/4 x 17	3		☒345162	
25-30' - AL, SK	15-1/4 R 19	3	SS	48-13700A41	☐033030	14-1/2 x 19	3	☒345133		
25-30' - AL, SK	15-1/4 L 19	3	SS	48-13701A41	☐033029	14-1/2 x 19	3		☒345163	
23-27' - AL, SK	14-3/4 R 21	3	SS	48-13702A41	☐033032	14-3/8 x 21	3	☒345134		
23-27' - AL, SK	14-3/4 L 21	3	SS	48-13703A41	☐033031	14-3/8 x 21	3		☒345164	
22-25' - AL, SK	14-5/8 R 23	3	SS	48-13704A41	☐033034	14-1/4 x 23	3	☒345135		
22-25' - AL, SK	14-5/8 L 23	3	SS	48-13705A41	☐033033	14-1/4 x 23	3		☒345165	
21-24' - AL, SK	14-1/2 R 25	3	SS	48-13706A41	☐033036	14-1/4 x 25	3	☒345136		
21-24' - AL, SK	14-1/2 L 25	3	SS	48-13707A41	☐033035					

Rubber Hub Bushing

**BRAVO ONE™ • OVER 365 HP • (SOLID HUB)** See Footnotes ■ & ▼  
**Thru Hub Exhaust & 15 Tooth Spline**

454 Magnum (385 HP) . . . . .1995 & Newer	450 HP . . . . .1995	500 HP . . . . .1996 & Newer
502 Magnum (390-415 HP) . . . . .1990 & Newer	465 HP . . . . .1991 & 94	525 HP (SC) (490-500) . . . . .1992 & Newer

Boat Length/Description	MICHIGAN MATCH REPLACEMENT PROPELLERS					
	Dia., Rot., Pitch	Bld#	Mat'l	OEM	Part No.	
26-32'	15-1/4 R 19	3	SS	48-13242A50	☐033052	
24-30'	14-3/4 R 21	3	SS	48-13244A50	☐033054	
24-30'	14-3/4 L 21	3	SS	48-13243A50	☐033053	
23-28'	14-5/8 L 23	3	SS	48-13245A50	☐033055	
21-26'	14-1/2 R 25	3	SS	48-13248A50	☐033058	
21-26'	14-1/2 L 25	3	SS	48-13247A50	☐033057	

Rubber Hub Bushing

Key to abbreviations: AL: All Loads; CR: Cruisers; HB: Houseboat; HL: Heavy Loads; LL: Light Loads; RB: Runabouts; SB: Sailboat; SK: Skiboat; WB: Workboat; WD: Weedless

- When replacing Flo-Torq II™ plastic hub props, aft castle thrust washer 12-31211A2 and conductivity (start) washer 13-42351-1 are required in addition to the other hardware supplied with original propeller. For complete details, see page 22. All suggestions are based upon single engine boats. Add 4" of pitch for twin applications.
- ▼ Wave Propellers used on Alpha One™ drives require use of anodic plate 76214A5 or high performance trim tab 822777A1 in place of standard trim tab.
- LIMITED INVENTORY ITEMS.
- Solid Hub Wave Propellers include forward thrust washer 9500-120 and should be used in place of the existing one.
- ☒ When using Rapture™ and Ballistic™ propellers, to avoid damage or injury, replace standard trim tab with trim tab 822777A1 and use forward thrust washer 12-835467.

**MERCUISER - MODEL O**  
Thru Hub Exhaust & 11 Tooth Spline

HP Range: 60 HP  
For twin installation increase pitch 2".

Boat Length/Description	MICHIGAN MATCH REPLACEMENT PROPELLERS						Part No.			Rubber Hub Bushing
	Dia., Rot., Pitch	Bld#	Mat'l	OEM						
HB, Barges	10-1/4 R 10	3	AL	48-33774A1		032084				
22-35'	10-1/4 R 11	3	AL	48-38098A1		032085				
28-21'	10-1/4 R 12	3	AL	48-38094A1		032086				
Up to 17'	10-1/4 R 13	3	AL	48-38090A1		032087				

**MERCUISER I ('62-63) • MERCUISER 80, 90**

HP Range: 80-140 HP  
For twin installation increase pitch 2".

Boat Length/Description	MICHIGAN MATCH REPLACEMENT PROPELLERS						Part No.			Rubber Hub Bushing
	Dia., Rot., Pitch	Bld#	Mat'l	OEM						
HB, Barges	13 R 11	3	AL	48-35936A3		032089				
22-25'	13 R 13	3	AL	48-58826A3		032090				
20-23'	13 R 15	3	AL	48-32390A3		032091				
19-22'	13 R 17	3	AL	48-65022A1		032092				
18-21'	13 R 19	3	AL	48-65024A1		032093				
Up to 17'	13 R 21	3	AL	48-67280A1		032094				

**MERCUISER THRU 1982 • 110-330 HORSEPOWER** See Footnotes ■  
Thru Hub Exhaust & 15 Tooth Spline

MODELS 1A, 1B, 1C, 120, 140, 145 DTS & 165  
MODELS 228, 470, 485, 888, 898, 225S, 233, 255TRS, 260, 280 TRS & 330 TRS

Boat Length/Description	VORTEX™ PERFORMANCE PROPELLERS						RAPTURE™ XHS				Use XHS™ Hub Kit 102
	Dia., Rot., Pitch	Bld#	Mat'l	OEM	Part No.	Dia. x Pitch	Bld#	RH	LH		
22-26' - AL	15-1/4 R 15	3	AL		992002	14-1/4 x 15	3	993002	993012		
21-25' - AL	15 R 17	3	AL	48-79572A4	992003	14-1/4 x 17	3	993003	993013		
20-24' - AL	14-1/2 R 19	3	AL	48-79574A4	992004	14-1/4 x 19	3	993004	993014		
19-23' - AL	14-1/4 R 21	3	AL	48-79576A4	992005	14-1/4 x 21	3	993005	993015		
18-22' - AL	14 R 23	3	AL	48-79578A4	992006	14-1/4 x 23	3	993006	993016		
Up to 17' - AL						14-1/4 x 25	3	993007	993017		
	15 R 16	4	AL		992202						
	14-1/2 R 18	4	AL		992203						
	14 R 20	4	AL		992204						

Boat Length/Description	MICHIGAN MATCH REPLACEMENT PROPELLERS						BALLISTIC™ STAINLESS STEEL PROPS				Rubber Hub Bushing
	Dia., Rot., Pitch	Bld#	Mat'l	OEM	Part No.	Dia. x Pitch	Bld#	RH	LH		
22-26' - AL						14-7/8 x 15	3	345131			
21-25' - AL	15-3/4 R 17	3	AL	48-79572A4	▼031036	14-3/4 x 17	3	345132	345162		
21-25' - AL	15-3/4 R 17	3	SS		▶033007						
20-24' - AL	15-1/2 R 19	3	AL	48-79574A4	▼031037	14-1/2 x 19	3	345133	345163		
20-24' - AL	15-1/2 R 19	3	SS		▶033008						
19-23' - AL	15-1/4 R 21	3	AL	48-79576A4	▼031038	14-3/8 x 21	3	345134	345164		
19-23' - AL	15-1/4 R 21	3	SS		▶033009						
18-22' - AL	15 R 23	3	AL	48-79578A4	▼031039	14-1/4 x 23	3	345135	345165		
Up to 17' - AL						14-1/4 x 25	3	345136			

Key to abbreviations: AL: All Loads; CR: Cruisers; HB: Houseboat; HL: Heavy Loads; LL: Light Loads; RB: Runabouts; SB: Sailboat; SK: Skiboat; WB: Workboat; WD: Weedless

- When replacing Flo-Torq II™ plastic hub props, aft castle thrust washer 12-31211A2 and conductivity (start) washer 13-42351-1 are required in addition to the other hardware supplied with original propeller. For complete details, see page 22. All suggestions are based upon single engine boats. Add 4" of pitch for twin applications.
- ▼ Caution: Use standard trim tab 34127A1 (except for Rapture™ and Ballistic™ use 822777A1) and forward thrust washer 13191A1.
- ▶ LIMITED INVENTORY ITEMS.
- ※ When using Rapture™ and Ballistic™ propellers, to avoid damage or injury, replace standard trim tab with trim tab 822777A1 and use forward thrust washer 12-835467.

**MERCUISER THRU 1982 • 110-330 HORSEPOWER**  
**Thru Hub Exhaust & 19 Tooth Spline**

See Footnotes ■

Mercruiser II-TR, 215E & 215H, TR, Bravo Two  
 For twin installation increase pitch 2".

Boat Length/Description	MICHIGAN MATCH REPLACEMENT PROPELLERS						Part No.			Rubber Hub Bushing
	Dia., Rot., Pitch	Bld#	Mat'l	OEM						
25-34'	20 R 17	3	AL	48-77896A10		<b>032113</b>				
25-34'	20 L 17	3	AL	48-77897A10		<b>032114</b>				
25-30'	19-3/4 R 19	3	AL	48-77898A10		<b>032115</b>				
25-30'	19-3/4 L 19	3	AL	48-77899A10		<b>032116</b>				
22-28'	19-1/2 R 21	3	AL	48-77900A10		<b>032117</b>				
22-28'	19-1/2 L 21	3	AL	48-77901A10		<b>032118</b>				

**OMC - OUTBOARD MARINE**

**STERNDRIVES**

**MODEL 400, COBRA®**  
**Thru Hub Exhaust & 13 Tooth Spline**

Model 400 Cobra®  
 2.3 L (120 HP) .....Thru 1991 2.3 L (128 HP) .....1988-91  
 2.5 L (120 HP) .....1978-84 2.5 L (120 HP) .....1985-87  
 3.0 L (140 HP) .....Thru 1989 3.0 L (140 HP) .....1985-87

Boat Length/Description	VORTEX XHS™ PERFORMANCE PROPELLERS						CAPTURE XHS™				Use XHS™ Hub Kit <b>106</b> Do NOT use Gearcase Adapter Ring supplied with propeller.
	Dia., Rot., Pitch	Bld#	Mat'l	OEM	Part No.	Dia. x Pitch	Bld#	RH	LH		
19-22' - RB, SK	13-3/4 R 15	3	AL	391198	<b>992103</b>	13-1/4 x 15	3	<b>993103</b>			
18-21' - RB, SK	13-1/4 R 17	3	AL	391199	<b>992104</b>	13-1/4 x 17	3	<b>993104</b>			
17-20' - RB, SK	13 R 19	3	AL	390896	<b>992105</b>	13-1/4 x 19	3	<b>993105</b>			
15-18' - RB, SK	12-3/4 R 21	3	AL	389788	<b>992106</b>	13-1/4 x 21	3	<b>993106</b>			

Boat Length - (MPH)	MICHIGAN MATCH REPLACEMENT PROPELLERS						BALLISTIC™ STAINLESS STEEL PROPS				Rubber Hub Bushing
	Dia., Rot., Pitch	Bld#	Mat'l	OEM	Part No.	Dia. x Pitch	Bld#	RH	LH		
WB - (6-16)	14 R 11	3	AL	382761	<b>012047</b>						
CR, HB - (14-26)	14 R 13	3	AL	391668	<b>011001</b>						
19-22' - (24-37)	13-3/4 R 15	3	AL	391198	<b>011002</b>	13-5/8 x 15	3	<b>335030</b>			
19-22' - (24-37)	13-3/4 R 15	3	SS	389949	<b>013028</b>						
17-20' - (30-45)	13-1/4 R 17	3	AL	391199	<b>011003</b>	13-1/2 x 17	3	<b>335031</b>			
17-20' - (30-45)	13-3/8 R 17	3	SS	389948	<b>013030</b>						
17-20' - (30-45)	14 R 17	3	AL	176214	<b>★011024</b>						
16-19' - (36-50)	13 R 19	3	AL	390896	<b>011006</b>	13-3/8 x 19	3	<b>335032</b>			
16-19' - (36-50)	13 R 19	3	SS	389510	<b>013033</b>						
16-19' - (36-50)	14 R 19	3	AL	176215	<b>★011025</b>						
15-18' - (41-53)	12-3/4 R 21	3	AL	389788	<b>011005</b>	13-1/8 x 21	3	<b>335033</b>			
15-18' - (41-53)	12-3/4 R 21	3	SS	389512	<b>013034</b>						
15-18' - (41-53)	14 R 21	3	AL	176216	<b>★011026</b>						

Key to abbreviations: AL: All Loads; CR: Cruisers; HB: Houseboat; HL: Heavy Loads; LL: Light Loads; RB: Runabouts; SB: Sailboat; SK: Skiboat; WB: Workboat; WD: Weedless



★ Indicates a cupped propeller.





## MODEL 800, KING COBRA®, COBRA® 1991-94

Thru Hub Exhaust & 15 Tooth Spline

3.0 L .....1991-93      4.3 L .....1991-93      5.8 L (Cobra) .....1991-93  
 3.2 L (Diesel) .....1992-93      5.0 L .....1991-93  
 Includes H.O. & EFI Models .....      Use Thrust Washer 126870

Boat Length/Description										
	Dia., Rot., Pitch	Bld#	Mat'l	OEM	Part No.	Dia. x Pitch	Bld#	RH	LH	
22-28'	15-1/4 R 15	3	AL		992002	14-1/4 x 15	3	993002	993012	
19-26'	15 R 17	3	AL		992003	14-1/4 x 17	3	993003	993013	
18-24'	14-1/2 R 19	3	AL		992004	14-1/4 x 19	3	993004	993014	
17-22'	14-1/4 R 21	3	AL		992005	14-1/4 x 21	3	993005	993015	
High Performance	14 R 23	3	AL		992006	14-1/4 x 23	3	993006	993016	
High Performance						14-1/4 x 25	3	993007	993017	
	15 R 16	4	AL		992202					
	14-1/2 R 18	4	AL		992203					
	14 R 20	4	AL		992204					

Use XHS™  
Hub Kit  
**100**

Boat Length/Description										
	Dia., Rot., Pitch	Bld#	Mat'l	OEM	Part No.	Dia. x Pitch	Bld#	RH	LH	
Non-Plane Heavy CR	15-1/2 R 10	3	AL		011015					
Non-Plane Heavy CR	15-1/2 R 13	3	AL	391536	011016					
22-26' - (22-32)	15-1/2 R 15	3	AL	391535	011006					
19-24' - (28-35)	15 R 15	3	SS	174926	013052	14-7/8 x 15	3	345031		
19-24' - (28-35)	15 L 15	3	SS	174927	013051					
18-24' - (30-39)	15 R 17	3	AL	391200	011007	14-3/4 x 17	3	345032	345062	
18-24' - (30-39)	15 R 17	3	SS	391290	013044					
18-24' - (30-39)	15 L 17	3	SS	431930	013043					
17-20' - (36-44)	14-1/2 R 19	3	AL	391201	011008	14-1/2 x 19	3	345033	345063	
17-20' - (36-44)	14-1/2 R 19	3	SS	389924	013046					
17-20' - (36-44)	14-1/2 L 19	3	SS	390821	013045					
16-19' - (40-49)	14-1/4 R 21	3	AL	391202	011009	14-3/8 x 21	3	345034	345064	
16-19' - (40-49)	14-1/4 R 21	3	SS	389923	013048					
16-19' - (40-49)	14-1/4 L 21	3	SS	390822	013047					
15-20' - (45-56)	14-1/4 R 23	3	AL	391203	011010	14-1/4 x 23	3	345035	345065	
15-20' - (45-56)	14-1/4 R 23	3	SS	389019	013050					
High Perf. - (50-60)						14-1/4 x 25	3	345036		
16-19' High Perf.						14-1/2 x 22	3	345041 (XL)		
15-18' High Perf.						14-1/2 x 24	3	345037 (XL)		

Rubber  
Hub  
Bushing

Key to abbreviations: AL: All Loads; CR: Cruisers; HB: Houseboat; HL: Heavy Loads; LL: Light Loads; RB: Runabouts; SB: Sailboat; SK: Skiboat; WB: Workboat; WD: Weedless

## MODEL 800, KING COBRA®, COBRA® 1978-90

Thru Hub Exhaust & 15 Tooth Spline



5.7 L .....1978-90

7.4 L .....1990



7.5 L .....1987-90

Includes H.O. & EFI Models . . . .

Use Thrust Washer 126870

Boat Length/Description									
	Dia., Rot., Pitch	Bld#	Mat'l	OEM	Part No.	Dia. x Pitch	Bld#	RH	LH
22-28'	15-1/4 R 15	3	AL		992002	14-1/4 x 15	3	993002	993012
19-26'	15 R 17	3	AL		992003	14-1/4 x 17	3	993003	993013
18-24'	14-1/2 R 19	3	AL		992004	14-1/4 x 19	3	993004	993014
17-22'	14-1/4 R 21	3	AL		992005	14-1/4 x 21	3	993005	993015
High Performance	14 R 23	3	AL		992006	14-1/4 x 23	3	993006	993016
High Performance						14-1/4 x 25	3	993007	993017
	15 R 16	4	AL		992202				
	14-1/2 R 18	4	AL		992203				
	14 R 20	4	AL		992204				

Use XHS™  
Hub Kit  
**101**



Boat Length - (MPH)									
	Dia., Rot., Pitch	Bld#	Mat'l	OEM	Part No.	Dia. x Pitch	Bld#	RH	LH
Heavy CR - (25-32)	15-1/2 R 13	3	AL	391536	011016				
22-28' - (30-27)	15-1/2 R 15	3	AL	391535	011006				
19-26' - (33-39)	15 R 15	3	SS	174926	013052	14-7/8 x 15	3	345031	
19-26' - (33-39)	15 L 15	3	SS	174927	013051				
19-26' - (35-46)	15 R 17	3	AL	391200	011007	14-3/4 x 17	3	345032	345062
19-26' - (35-46)	15 R 17	3	SS	391290	013044				
19-26' - (35-46)	15 L 17	3	SS	431930	013043				
18-24' - (40-52)	14-1/2 R 19	3	AL	391201	011008	14-1/2 x 19	3	345033	345063
18-24' - (40-52)	14-1/2 R 19	3	SS	389924	013046				
18-24' - (40-52)	14-1/2 L 19	3	SS	390821	013045				
17-22' - (46-60)	14-1/4 R 21	3	AL	391202	011009	14-3/8 x 21	3	345034	345064
17-22' - (46-60)	14-1/4 R 21	3	SS	389923	013048				
17-22' - (46-60)	14-1/4 L 21	3	SS	390822	013047				
High Perf. - (51-66)	14-1/4 R 23	3	AL	391203	011010	14-1/4 x 23	3	345035	345065
High Perf. - (51-66)	14-1/4 R 23	3	SS	389019	013050				
High Perf. - (55-66)						14-1/4 x 25	3	345036	
High Performance						14-1/2 x 22	3	345041 (XL)	
High Performance						14-1/2 x 24	3	345037 (XL)	
High Performance						14-1/2 x 26	3	345038 (XL)	

Rubber  
Hub  
Bushing



Key to abbreviations: AL: All Loads; CR: Cruisers; HB: Houseboat; HL: Heavy Loads; LL: Light Loads; RB: Runabouts; SB: Sailboat; SK: Skiboat; WB: Workboat; WD: Weedless

## MODEL 800, KING COBRA®, COBRA® 1991-94 Thru Hub Exhaust & 15 Tooth Spline

5.7 L .....1991-93                      7.4 L .....1991-93                      8.2 L .....1992-93  
 5.8 L (King Cobra) .....1992-94  
 Includes H.O. & EFI Models . . . . .                      Use Thrust Washer 126870

Boat Length/Description											
	Dia.,	Rot.,	Pitch	Bld#	Mat'l	OEM	Part No.	Dia. x Pitch	Bld#	RH	LH
22-28'	15-1/4	R	15	3	AL		<b>992002</b>	14-1/4 x 15	3	<b>993002</b>	<b>993012</b>
19-26'	15	R	17	3	AL		<b>992003</b>	14-1/4 x 17	3	<b>993003</b>	<b>993013</b>
18-24'	14-1/2	R	19	3	AL		<b>992004</b>	14-1/4 x 19	3	<b>993004</b>	<b>993014</b>
17-22'	14-1/4	R	21	3	AL		<b>992005</b>	14-1/4 x 21	3	<b>993005</b>	<b>993015</b>
High Perf.	14	R	23	3	AL		<b>992006</b>	14-1/4 x 23	3	<b>993006</b>	<b>993016</b>
High Perf.								14-1/4 x 25	3	<b>993007</b>	<b>993017</b>
	15	R	16	4	AL		<b>992202</b>				
	14-1/2	R	18	4	AL		<b>992203</b>				
	14	R	20	4	AL		<b>992204</b>				

Use XHS™  
Hub Kit  
**101**

Boat Length - (MPH)											
	Dia.,	Rot.,	Pitch	Bld#	Mat'l	OEM	Part No.	Dia. x Pitch	Bld#	RH	LH
Heavy CR - (25-32)	15-1/2	R	13	3	AL	391536	<b>011016</b>				
22-28' - (30-27)	15-1/2	R	15	3	AL	391535	<b>011006</b>				
19-26' - (33-39)	15	R	15	3	SS	174926	<b>013052</b>	14-7/8 x 15	3	<b>345031</b>	
19-26' - (33-39)	15	L	15	3	SS	174927	<b>013051</b>				
19-26' - (35-46)	15	R	17	3	AL	391200	<b>011007</b>	14-3/4 x 17	3	<b>345032</b>	<b>345062</b>
19-26' - (35-46)	15	R	17	3	SS	391290	<b>013044</b>				
19-26' - (35-46)	15	L	17	3	SS	431930	<b>013043</b>				
18-24' - (40-52)	14-1/2	R	19	3	AL	391201	<b>011008</b>	14-1/2 x 19	3	<b>345033</b>	<b>345063</b>
18-24' - (40-52)	14-1/2	R	19	3	SS	389924	<b>013046</b>				
18-24' - (40-52)	14-1/2	L	19	3	SS	390821	<b>013045</b>				
17-22' - (46-60)	14-1/4	R	21	3	AL	391202	<b>011009</b>	14-3/8 x 21	3	<b>345034</b>	<b>345064</b>
17-22' - (46-60)	14-1/4	R	21	3	SS	389923	<b>013048</b>				
17-22' - (46-60)	14-1/4	L	21	3	SS	390822	<b>013047</b>				
High Perf. - (51-66)	14-1/4	R	23	3	AL	391203	<b>011010</b>	14-1/4 x 23	3	<b>345035</b>	<b>345065</b>
High Perf. - (51-66)	14-1/4	R	23	3	SS	389019	<b>013050</b>				
High Perf. - (55-66)								14-1/4 x 25	3	<b>345036</b>	
High Performance								14-1/2 x 22	3	<b>345041</b>	(XL)
High Performance								14-1/2 x 24	3	<b>345037</b>	(XL)
High Performance								14-1/2 x 26	3	<b>345038</b>	(XL)

Rubber  
Hub  
Bushing

## OMC SAILDRIVE®

### Non-Thru Hub Exhaust & 2 Tooth / Pin Drive

Saildrive

Boat Length/Description	MICHIGAN MATCH REPLACEMENT PROPELLERS						Part No.	Rubber Hub Bushing
	Dia., Rot., Pitch	Bld#	Mat'l	OEM				
	10-1/2 R 10	3	AL	376738		012027		

## MODEL 14 LARGE GEARCASE 1967-77

### Non-Thru Hub Exhaust & 2 Tooth / Pin Drive

Suggestion: For twin installation increase pitch 2".

Boat Length/Description	MICHIGAN MATCH REPLACEMENT PROPELLERS						Part No.	Rubber Hub Bushing
	Dia., Rot., Pitch	Bld#	Mat'l	OEM				
HP Range: 120-245	14 R 11	3	AL	382676		012089		
	14 R 12	3	AL	382017		012090		
	14 R 14	3	AL	381185		012091		
	14 R 16	3	AL	381186		012092		
	14 R 18	3	AL	381187		012093		
	14 R 20	3	AL	383287		012094		

## 80-90 HP CYCLE SMALL GEARCASE 1968 • MARINE DRIVE SYSTEMS/RANGER

### Thru Hub Exhaust & 2 Tooth / Pin Drive

Suggestion: For twin installation increase pitch 2".

Boat Length/Description	MICHIGAN MATCH REPLACEMENT PROPELLERS						Part No.	Rubber Hub Bushing
	Dia., Rot., Pitch	Bld#	Mat'l	OEM				
HP Range: 80-120	10-1/4 R 10	3	AL	378040		012043		
	10 R 11	3	AL	377978		012044		
	10 R 12	3	AL	378039		012045		
	10 R 9-1/4	3	AL	379260		♦012042		

## SEA DRIVE® 1982 & NEWER • 4-1/4" GEARCASE

### Thru Hub Exhaust & 13 Tooth Spline

1.6 L V-4 .....1982 & Newer      1.8 L V-4 .....1987 & Newer

For twin installation increase pitch 2"

Boat Length - (MPH)	MICHIGAN MATCH REPLACEMENT PROPELLERS						BALLISTIC® STAINLESS STEEL PROPS				Rubber Hub Bushing
	Dia., Rot., Pitch	Bld#	Mat'l	OEM	Part No.	Dia. x Pitch	Bld#	RH	LH		
Barges, HB - (1-18)	14 R 11	3	AL	382761	012047						
26' & Up - (14-28)	14 R 13	3	AL	391668	011001						
22-26' - (24-36)	13-3/4 R 15	3	AL	391198	011002	13-5/8 x 15	3	335030			
22-26' - (24-36)	13-3/4 R 15	3	SS	389949	013028						
19-22' - (30-40)	13-1/4 R 17	3	AL	391199	011003	13-1/2 x 17	3	335031			
19-22' - (30-40)	13-3/8 R 17	3	SS	389948	013030						
19-22' - (30-40)	14 R 17	3	AL	176214	★011024						
17-20' - (38-50)	13 R 19	3	AL	390896	011004	13-3/8 x 19	3	335032			
17-20' - (38-50)	13 R 19	3	SS	389510	013033						
17-20' - (38-50)	14 R 19	3	AL	176215	★011025						
15-18' - (44-56)	12-3/4 R 21	3	AL	389788	011005	13-1/8 x 21	3	335033			
15-18' - (44-56)	12-3/4 R 21	3	SS	389512	013034						
15-18' - (44-56)	14 R 21	3	AL	176216	★011026						

Key to abbreviations: AL: All Loads; CR: Cruisers; HB: Houseboat; HL: Heavy Loads; LL: Light Loads; RB: Runabouts; SB: Sailboat; SK: Skiboat; WB: Workboat; WD: Weedless

♦ Small hub propeller - uses special nut part number 302001.

★ Indicates a cupped propeller.





## SEA DRIVE® (1982-90) • 4-3/4" LARGE GEARCASE

Thru Hub Exhaust & 15 Tooth Spline

2.0 L V-4 .....1989-90	2.7 L V-6 .....1987-90	3.6 L V-8 .....1987-90
2.5 L V-6 .....1982-87	3.0 L V-6 .....1989-90	4.0 L V-8 .....1989 & Newer
2.6 L V-6 .....1982-90		

Following suggestions based on Twin Engines - Deduct 4" pitch for single engine application.

Boat Length/Description										
	Dia., Rot., Pitch	Bld#	Mat'l	OEM	Part No.	Dia. x Pitch	Bld#	RH	LH	
32-36' Twin	15-1/4 R 15	3	AL		992002	14-1/4 x 15	3	993002	993012	
30-33' Twin	15 R 17	3	AL		992003	14-1/4 x 17	3	993003	993013	
27-30' Twin	14-1/2 R 19	3	AL		992004	14-1/4 x 19	3	993004	993014	
25-28' Twin	14-1/4 R 21	3	AL		992005	14-1/4 x 21	3	993005	993015	
23-25' Twin	14 R 23	3	AL		992006	14-1/4 x 23	3	993006	993016	
18-22' Twin						14-1/4 x 25	3	993007	993017	
	15 R 16	4	AL		992202					
	14-1/2 R 18	4	AL		992203					
	14 R 20	4	AL		992204					

Use XHS™  
Hub Kit  
**101**

Boat Length - (MPH)										
	Dia., Rot., Pitch	Bld#	Mat'l	OEM	Part No.	Dia. x Pitch	Bld#	RH	LH	
Barges, HB - (10-25)	15-1/2 R 13	3	AL	391536	011016					
32-36' Twin - (24-34)	15-1/2 R 15	3	AL	391535	011006					
32-36' Twin - (27-36)	15 R 15	3	SS	174926	013052	14-7/8 x 15	3	345031		
32-36' Twin - (27-36)	15 L 15	3	SS	174927	013051					
30-33' Twin - (30-40)	15 R 17	3	AL	391200	011007	14-3/4 x 17	3	345032	345062	
30-33' Twin - (30-40)	15 R 17	3	SS	391290	013044					
30-33' Twin - (30-40)	15 L 17	3	SS	431930	013043					
27-30' Twin - (36-47)	14-1/2 R 19	3	AL	391201	011008	14-1/2 x 19	3	345033	345063	
27-30' Twin - (36-47)	14-1/2 R 19	3	SS	389924	013046					
27-30' Twin - (36-47)	14-1/2 L 19	3	SS	390821	013045					
25-28' Twin - (42-54)	14-1/4 R 21	3	AL	391202	011009	14-3/8 x 21	3	345034	345064	
25-28' Twin - (42-54)	14-1/4 R 21	3	SS	389923	013048					
25-28' Twin - (42-54)	14-1/4 L 21	3	SS	390822	013047					
23-25' Twin - (50-62)	14-1/4 R 23	3	AL	391203	011010	14-1/4 x 23	3	345035	345065	
23-25' Twin - (50-62)	14-1/4 R 23	3	SS	389019	013050					
18-22' Twin - (56-68)						14-1/4 x 25	3	345036		



Rubber  
Hub  
Bushing

Key to abbreviations: AL: All Loads; CR: Cruisers; HB: Houseboat; HL: Heavy Loads; LL: Light Loads; RB: Runabouts; SB: Sailboat; SK: Skiboat; WB: Workboat; WD: Weedless



## SEA DRIVE® (1991 & NEWER) • 4-3/4" LARGE GEARCASE Thru Hub Exhaust & 15 Tooth Spline

2.0 L V-4 .....1991 & Newer      2.7 L V-6 .....1991 & Newer      3.6 L V-8 .....1991 & Newer  
 2.6 L V-6 .....1991 & Newer      3.0 L V-6 .....1991 & Newer      4.0 L V-8 .....1991 & Newer

Following suggestions based on Twin Engines - Deduct 4" pitch for single engine application.

Boat Length/Description										
	Dia., Rot., Pitch	Bld#	Mat'l	OEM	Part No.	Dia. x Pitch	Bld#	RH	LH	
32-36' Twin	15-1/4 R 15	3	AL		992002	14-1/4 x 15	3	993002	993012	
30-33' Twin	15 R 17	3	AL		992003	14-1/4 x 17	3	993003	993013	
27-30' Twin	14-1/2 R 19	3	AL		992004	14-1/4 x 19	3	993004	993014	
25-28' Twin	14-1/4 R 21	3	AL		992005	14-1/4 x 21	3	993005	993015	
23-25' Twin	14 R 23	3	AL		992006	14-1/4 x 23	3	993006	993016	
18-22' Twin						14-1/4 x 25	3	993007	993017	
	15 R 16	4	AL		992202					
	14-1/2 R 18	4	AL		992203					
	14 R 20	4	AL		992204					

Use XHS™  
Hub Kit  
**100**

Boat Length - (MPH)										
	Dia., Rot., Pitch	Bld#	Mat'l	OEM	Part No.	Dia. x Pitch	Bld#	RH	LH	
Barges, HB - (10-25)	15-1/2 R 13	3	AL	391536	011016					
32-36' Twin - (24-34)	15-1/2 R 15	3	AL	391535	011006					
32-36' Twin - (27-36)	15 R 15	3	SS	174926	013052	14-7/8 x 15	3	345031		
32-36' Twin - (27-36)	15 L 15	3	SS	174927	013051					
30-33' Twin - (30-40)	15 R 17	3	AL	391200	011007	14-3/4 x 17	3	345032	345062	
30-33' Twin - (30-40)	15 R 17	3	SS	391290	013044					
30-33' Twin - (30-40)	15 L 17	3	SS	431930	013043					
27-30' Twin - (36-47)	14-1/2 R 19	3	AL	391201	011008	14-1/2 x 19	3	345033	345063	
27-30' Twin - (36-47)	14-1/2 R 19	3	SS	389924	013046					
27-30' Twin - (36-47)	14-1/2 L 19	3	SS	390821	013045					
25-28' Twin - (42-54)	14-1/4 R 21	3	AL	391202	011009	14-3/8 x 21	3	345034	345064	
25-28' Twin - (42-54)	14-1/4 R 21	3	SS	389923	013048					
25-28' Twin - (42-54)	14-1/4 L 21	3	SS	390822	013047					
23-25' Twin - (50-62)	14-1/4 R 23	3	AL	391203	011010	14-1/4 x 23	3	345035	345065	
23-25' Twin - (50-62)	14-1/4 R 23	3	SS	389019	013050					
18-22' Twin - (56-68)						14-1/4 x 25	3	345036		

Rubber  
Hub  
Bushing

**FOR OMC COBRA® (1994 & NEWER), SX COBRA™, VOLVO PENTA SX™ SEE PAGE 47**

Key to abbreviations: AL: All Loads; CR: Cruisers; HB: Houseboat; HL: Heavy Loads; LL: Light Loads; RB: Runabouts; SB: Sailboat; SK: Skiboat; WB: Workboat; WD: Weedless

AQUAMATIC 200, 250, 270, 275, 280, 290 SP					
Motor HP	Gear Ratio	Approximate Boat Length			Houseboats Barges
		Thru 17'	18-21'	22-25'	
110-140 HP	1.35:1	14 x 15		14 x 15	15 x 13
	1.62:1	14 x 17	14 x 15	14 x 17	
	2.15:1	14 x 19	14 x 17		
150-185 HP	1.35:1	14 x 17	14 x 17	15 x 13	15 x 15 15 x 13
	1.61:1	14 x 21	14 x 21	15 x 17	
	1.89:1	14 x 19	14 x 19	15 x 15	
190-255 HP	1.35:1	14 x 21	15 x 19	15 x 17	16 x 13
	1.61:1	14 x 23	16 x 17	16 x 17	
230-260 HP	1.61:1	14 x 23	14 x 23	15 x 21	
290 HP	1.61:1	14 x 23	14 x 23	14 x 21	



Volvo Long Hub Aluminum



Volvo Standard Hub Aluminum

### Long Hub Propellers Non-Thru Hub Exhaust & 17 Tooth Spline Nearest Michigan Match™ OEM Equivalent

Dia. x Pitch	Rot.	Blades	Aluminum Part No.		Stainless Steel Part No.	
			OEM	Michigan	OEM	Michigan
14 x 17	RH	3	854286-4	♣082002-1		♣084006
14 x 17	LH	3	854977-6	♣082001-1		
14 x 19	RH	3	854993-3	♣082004-1		♣084008
14 x 19	LH	3	854978-4	♣082003-1		
14 x 21	RH	3	851139-6	♣082010-1		
14 x 21	LH	3	854979-2	♣082009-1		
15 x 17	RH	3	854997-4	♣082012-1		
15 x 17	LH	3	854982-6	♣082011-1		
15 x 19	RH	3	854998-2	♣082014-1		
15 x 19	LH	3	854983-4	♣082013-1		
15 x 21	RH	3	854999-0	♣082016-1		
15 x 21	LH	3	854984-2	♣082015-1		
16 x 13	LH	3	854986-7	082089-1		
16 x 15	RH	3	872001-3	082090-1		
16 x 15	LH	3	854987-5	082091-1		
16 x 17	RH	3	872002-1	082092-1		
16 x 17	LH	3	854988-3	082093-1		
15-1/4 x 17	RH	3	SSV Series Stainless	852155-1♣	083002	
15-1/4 x 17	LH	3	SSV Series Stainless	852086-8♣	083001	
15 x 19	RH	3	SSV Series Stainless	852138-7♣	083004	
15 x 19	LH	3	SSV Series Stainless	852085-0♣	082003	
14-1/2 x 21	RH	3	SSV Series Stainless	852137-9♣	083006	
14-1/2 x 21	LH	3	SSV Series Stainless	852087-6♣	083005	

### Standard Hub Propellers Non-Thru Hub Exhaust & 17 Tooth Spline Nearest Michigan Match™ OEM Equivalent

Dia. x Pitch	Rot.	Blades	Aluminum Part No.	
			OEM	Michigan
14 x 15	RH	3	814631-8	082026-1
14 x 15	LH	3	814626-8	082025-1
14 x 17	RH	3	814632-6	082028-1
14 x 17	LH	3	814627-6	082027-1
14 x 19	RH	3	814633-4	082032-1
14 x 19	LH	3	814628-4	082031-1
14 x 21	RH	3	814634-2	082034
14 x 21	LH	3	814629-2	082033
15 x 13	LH	3	813319-7	082087-1
15 x 15	RH	3	814615-1	082060-1
15 x 15	LH	3	814611-0	082059-1
15 x 17	RH	3	814616-9	082030-1
15 x 17	LH	3	814612-8	082029-1
15 x 19	RH	3	-	082022
15 x 19	LH	3	-	082021
15 x 21	LH	3	-	082023

♣ Note: Bushings for above propellers suggested for max. 240 HP UNLESS marked with a ♣.  
**SSV Series:** 1) Designed for boats with power to weight ratios of 12:1 and below. 2) Boats must have power trim. 3) Anti-cavitation plate height 1" above boat bottom. 4) Blades cambered must run in ventilated condition. 5) Use 2" less pitch if current aluminum prop is cupped, 3" less if uncupped. Parts 083005 & 083006 will not fit a 270 outdrive.

Long Hub Propellers are for use with model 275, 280 & 290 outdrives and late production 270 outdrives which have drilled propeller shaft.  
 Standard Hub Propeller installations are from outdrive serial #PZ2877179, and are NOT for use with V-6 diesel engines.

Propeller Hardware is available thru Volvo Distributors.  
 ▶ LIMITED INVENTORY ITEMS.

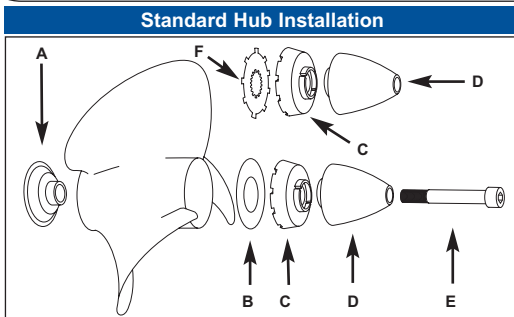

- Standard Hub Propeller installations require:**  
 A) Thrust Washer #839534-5 (Depth: 625")  
 B) Washer #850888-9 or F) Washer #897367-9  
 C) Spacer Ring #854047-8  
 D) Propeller Cone #8504045-2  
 E) Allen bolt #850889-7

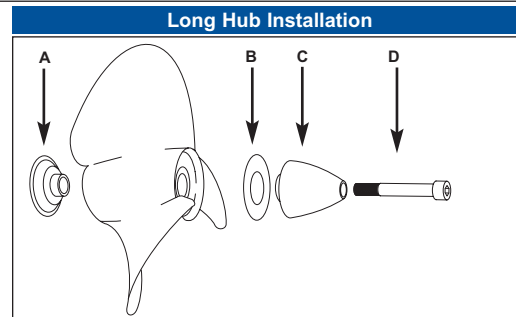

- Long Hub Propeller Hardware:**  
 A) Thrust Washer #839423-1 (Depth: 1.3")  
 B) Washer #850888-9  
 C) Propeller Cone #8504045-2  
 D) Allen bolt #850889-7

#### Volvo Standard Shaft

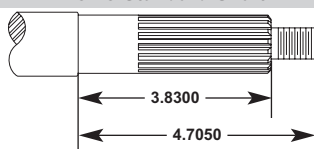

#### Volvo Long Shaft

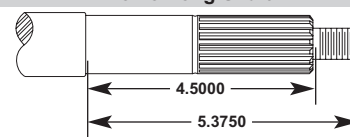

## VOLVO PENTA 100-110: EATON MODEL B

2 Tooth / Pin Drive

Boat Length/Description	MICHIGAN MATCH REPLACEMENT PROPELLERS						RAPTURE <sup>XHS</sup>				Rubber Hub Bushing
	Dia., Rot., Pitch	Bld#	Mat'l	OEM	Part No.						
HP Range: 110-150	14 L 10	3	AL	813226	▶082057						
	14 L 12	3	AL	813228	▶082045						

## SX COBRA™, VOLVO PENTA SX, OMC COBRA® 1994 & NEWER

Thru Hub Exhaust & 19 Tooth Spline

3.0 L .....1994 & Newer	7.4 L .....1997 & Newer	DPX 385 (385 HP) .....2001 & Newer
4.3 L .....1994 & Newer	8.2 L .....1997	DPX 415 (415 HP) .....2001 & Newer
5.0 L .....1994 & Newer	8.1 GI (375 HP) .....2001 & Newer	DPX 500 (475 HP) .....2001 & Newer
5.7 L .....1994 & Newer	8.1 GSI (420 HP) .....2001 & Newer	DPX 600 (560 HP) .....2001 & Newer
5.8 L .....1994-97		

Following suggestions based on Twin Engines - Deduct 4" pitch for single engine application.

Boat Length/Description	VORTEX <sup>XHS</sup> PERFORMANCE PROPELLERS						RAPTURE <sup>XHS</sup>				Use XHS™ Hub Kit 105
	Dia., Rot., Pitch	Bld#	Mat'l	OEM	Part No.	Dia. x Pitch	Bld#	RH	LH		
24-28'	15-1/4 R 15	3	AL		992002	14-1/4 x 15	3	993002	993012		
22-27'	15 R 17	3	AL		992003	14-1/4 x 17	3	993003	993013		
19-25'	14-1/2 R 19	3	AL		992004	14-1/4 x 19	3	993004	993014		
17-22'	14-1/4 R 21	3	AL		992005	14-1/4 x 21	3	993005	993015		
17-20'	14 R 23	3	AL		992006	14-1/4 x 23	3	993006	993016		
						14-1/4 x 25	3	993007	993017		
	15 R 16	4	AL		992202						
	14-1/2 R 18	4	AL		992203						
	14 R 20	4	AL		992204						



Boat Length - (MPH)	MICHIGAN MATCH REPLACEMENT PROPELLERS						BALLISTIC <sup>ST</sup> STAINLESS STEEL PROPS				Rubber Hub Bushing
	Dia., Rot., Pitch	Bld#	Mat'l	OEM	Part No.	Dia. x Pitch	Bld#	RH	LH		
24-28' - (26-36)	15-1/2 R 15	3	AL	3850299	161001						
24-28" - (26-36)	15 R 15	3	SS	3850305	163002	14-7/8 x 15	3	346031			
22-27' - (34-44)	15 R 17	3	AL	3850300	161002	14-3/4 x 17	3	346032	346062		
22-27' - (34-44)	15 R 17	3	SS	3850307	163004						
22-27' - (34-44)	15 L 17	3	SS	3850316	▶163003						
19-25' - (39-50)	14-1/2 R 19	3	AL	3850301	161003	14-1/2 x 19	3	346033	346063		
19-25' - (39-50)	14-1/2 R 19	3	SS	3850308	163006						
19-25' - (39-50)	14-1/2 L 19	3	SS	3850317	▶163005						
17-22' - (39-50)	14-1/4 R 21	3	AL	3850302	161004	14-3/8 x 21	3	346034	346064		
17-22' - (39-50)	14-1/4 R 21	3	SS	3850309	163008						
17-22' - (39-50)	14-1/4 L 21	3	AL	3850318	163007						
17-20' - (44-57)	14-1/4 R 23	3	AL	3850303	161005	14-1/4 x 23	3	346035	346065		
17-20' - (44-57)	14-1/4 R 23	3	SS	3850310	163010						
16-19' - (48-62)	14-1/4 L 23	3	SS	3850319	▶163009						

Key to abbreviations: AL: All Loads; CR: Cruisers; HB: Houseboat; HL: Heavy Loads; LL: Light Loads; RB: Runabouts; SB: Sailboat; SK: Skiboat; WB: Workboat; WD: Weedless



▶ LIMITED INVENTORY ITEMS.

## 130-205 HORSEPOWER Thru Hub Exhaust & 15 Tooth Spline

3.0 L (130 HP) EST/PSR . . . . .1989-93      4.3 L (205 HP) EST/YEMS/PRS .1989-93

Boat Length/Description										
	Dia., Rot., Pitch	Bld#	Mat'l	OEM	Part No.	Dia. x Pitch	Bld#	RH	LH	
21-26' - (18-31)	15-1/4 R 15	3	AL		992002	14-1/4 x 15	3	993002	993012	
19-23' - (27-37)	15 R 17	3	AL		992003	14-1/4 x 17	3	993003	993013	
17-21' - (33-42)	14-1/2 R 19	3	AL		992004	14-1/4 x 19	3	993004	993014	
18-19' - (37-46)	14-1/4 R 21	3	AL		992005	14-1/4 x 21	3	993005	993015	
17-19'	14 R 23	3	AL		992006	14-1/4 x 23	3	993006	993016	
Up to 18'						14-1/4 x 25	3	993007	993017	
20-24'	15 R 16	4	AL		992202					
19-23'	14-1/2 R 18	4	AL		992203					
18-19'	14 R 20	4	AL		992204					



Use XHS™  
Hub Kit  
**103**

Boat Length - (MPH)										
	Dia., Rot., Pitch	Bld#	Mat'l	OEM	Part No.	Dia. x Pitch	Bld#	RH	LH	
21-26' - (18-31)	15-1/4 R 15	3	AL	6G5-45941-00-98	101025	14-7/8 x 15	3	345931		
20-24' - (25-34)	14-5/8 R 16	3	AL	6G5-45952-00-98	101026					
19-23' - (27-37)	14-1/2 R 17	3	AL	6G5-45947-01-98	101027	14-3/4 x 17	3	345932	345962	
19-23' - (27-37)	14-1/2 R 17	3	SS	6G5-45978-03-98	103018					
17-21' - (33-42)	14 R 19	3	AL	6G5-45945-01-98	101028	14-1/2 x 19	3	345933	345963	
17-21' - (33-42)	14 R 19	3	SS	6G5-45974-03-98	103020					
18-19' - (37-46)	13-3/4 R 21	3	AL	6G5-45943-01-98	101029	14-3/8 x 21	3	345934	345964	
18-19' - (37-46)	13-3/4 R 21	3	SS	6G5-45972-03-98	103022					
17-19' - (39-48)	13-1/2 R 23	3	AL	6G5-45949-00-98	101030	14-1/4 x 23	3	345935	345965	
Up to 18' - (40-50)						14-1/4 x 25	3	345936		
16-20' High Perf.						14-1/2 x 22	3	345941 (XL)		
15-18' High Perf.						14-1/2 x 24	3	345937 (XL)		
Up to 17' High Perf.						14-1/2 x 26	3	345938 (XL)		



Rubber  
Hub  
Bushing

## 205-300 HORSEPOWER Thru Hub Exhaust & 15 Tooth Spline

5.0 L (205 HP) EST/PSR/YEMS .1989-93      5.7 L (260 HP) EST/PSR/YEMS .1989-93      7.4 L (300 HP) Hydra DrIVE (EST) 1992-93

Boat Length/Description										
	Dia., Rot., Pitch	Bld#	Mat'l	OEM	Part No.	Dia. x Pitch	Bld#	RH	LH	
23-28'	15-1/4 R 15	3	AL		992002	14-1/4 x 15	3	993002	993012	
21-26'	15 R 17	3	AL		992003	14-1/4 x 17	3	993003	993013	
19-25'	14-1/2 R 19	3	AL		992004	14-1/4 x 19	3	993004	993014	
19-23'	14-1/4 R 21	3	AL		992005	14-1/4 x 21	3	993005	993015	
17-22'	14 R 23	3	AL		992006	14-1/4 x 23	3	993006	993016	
						14-1/4 x 25	3	993007	993017	
22-27'	15 R 16	4	AL		992202					
19-25'	14-1/2 R 18	4	AL		992203					
18-23'	14 R 20	4	AL		992204					

Use XHS™  
Hub Kit  
**103**

Boat Length - (MPH)										
	Dia., Rot., Pitch	Bld#	Mat'l	OEM	Part No.	Dia. x Pitch	Bld#	RH	LH	
23-28' - (19-38)	15-1/4 R 15	3	AL	6G5-45941-00-98	101025	14-7/8 x 15	3	345931		
22-27' - (24-42)	14-5/8 R 16	3	AL	6G5-45952-00-98	101026					
21-26' - (29-45)	14-1/2 R 17	3	AL	6G5-45947-01-98	101027	14-3/4 x 17	3	345932	345962	
21-26' - (29-45)	14-1/2 R 17	3	SS	6G5-45978-03-98	103018					
19-25' - (35-49)	14 R 19	3	AL	6G5-45945-01-98	101028	14-1/2 x 19	3	345933	345963	
19-25' - (35-49)	14 R 19	3	SS	6G5-45974-03-98	103020					
18-23' - (41-56)	13-3/4 R 21	3	AL	6G5-45943-01-98	101029	14-3/8 x 21	3	345934	345964	
18-23' - (41-56)	13-3/4 R 21	3	SS	6G5-45972-03-98	103022					
17-22' - (43-58)	13-1/2 R 23	3	AL	6G5-45949-00-98	101030	14-1/4 x 23	3	345935	345965	

Rubber  
Hub  
Bushing

# XHS™ PROPELLER ACCESSORIES

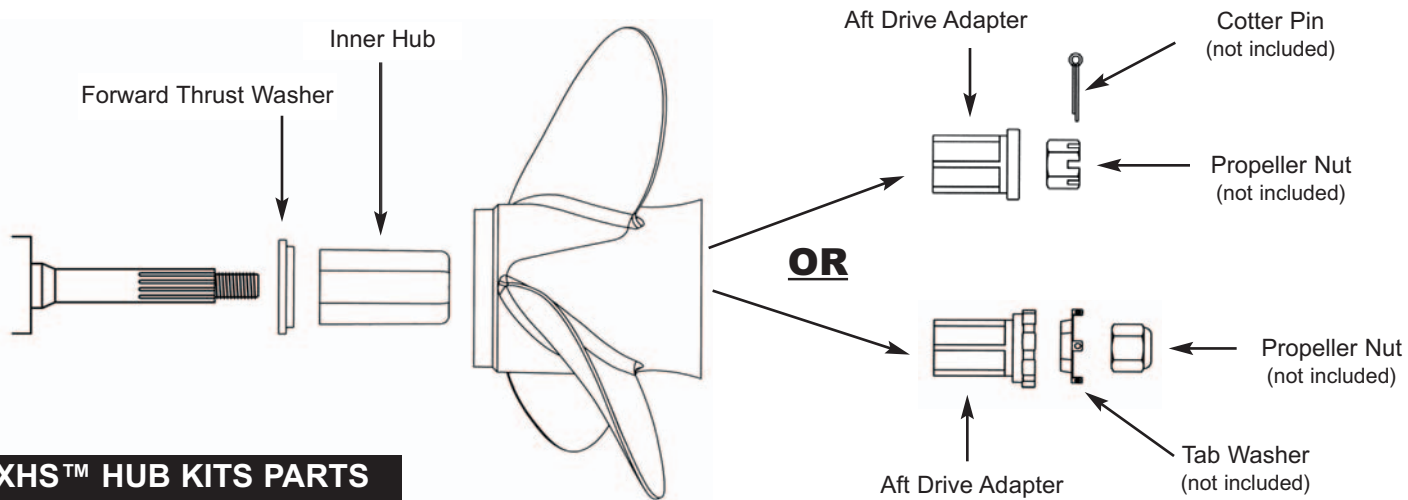

## XHS™ HUB KITS PARTS

Hub Kit	Description	Parts	
100	Evinrude/Johnson Outboards - OMC Sterndrives (V6/V8 Gearcase 1991 to present)	991202	Forward Thrust Washer
		991201	Inner Hub
		991203	Aft Drive Adapter
101	Evinrude/Johnson Outboards - OMC Sterndrives (V6/V8 Gearcase 1984 - 1990)	991204	Forward Thrust Washer
		991201	Inner Hub
		991203	Aft Drive Adapter
102	Mer cruiser Alpha One & Bravo One (less than 400 HP) Mercury/Mariner 60HP Bigfoot, 70-125 HP Mercury/Mariner/Force 135-250 HP Force 90-120 HP Honda Outboards 75-90 HP thru 1998 Yamaha Outboards thru 1983	991204	Forward Thrust Washer
		991201	Inner Hub
		991205	Aft Drive Adapter
103	Yamaha Outboards & Sterndrives (115-130 HP, 150-250 HP, V6 Gearcase 1984 to present)	991213	Forward Thrust Washer
		991201	Inner Hub
		991206	Aft Drive Adapter
104	Suzuki Outboards (150-225 HP, V6 Gearcase)	991207	Forward Thrust Washer
		991201	Inner Hub
		991208	Aft Drive Adapter
105	Volvo SX Sterndrives (19 tooth spline 1994 to present)	991202	Forward Thrust Washer
		991201	Inner Hub
		991208	Aft Drive Adapter
106	Evinrude/Johnson Outboards - OMC Sterndrives (V4 Gearcase 1968 to present)	991210	Forward Thrust Washer
		991201	Inner Hub
		991211	Aft Drive Adapter
107	Honda Outboards (115-130 HP 1998 to present, 75-90 HP 1999 to present)	991207	Forward Thrust Washer
		991201	Inner Hub
		991205	Aft Drive Adapter
108	Yamaha Outboards (50-100 HP, splined front thrust washer)	991212	Forward Thrust Washer
		991201	Inner Hub
		991206	Aft Drive Adapter
109	Nissan/Tohatsu Outboards (90-140 HP)	991213	Forward Thrust Washer
		991201	Inner Hub
		991214	Aft Drive Adapter
110	Suzuki V4 Outboards (60-140 HP)	991215	Forward Thrust Washer
		991201	Inner Hub
		991211	Aft Drive Adapter
High Horsepower Inner Hub (Mercury part # 850821A2)		991272	Solid Hub

# XHS™ PROPELLER ACCESSORIES (continued)

## XHS™ HUB KITS PARTS

Hub Kit	Description	Parts	
111	Evinrude/Johnson Outboards (40-70 HP)	991225	Urethane Cushion
		991247	Thrust Washer
		991232	Drive Adapter
112	Tohatsu/Nissan Outboards (50-70 HP)	991225	Urethane Cushion
		991273	Thrust Washer
		991232	Drive Adapter
113	Honda Outboards (35-50 HP)	991225	Urethane Cushion
		991234	Thrust Washer
		991227	Drive Adapter
114	Mercury/Mariner/Force Outboards (30-70 HP)	991225	Urethane Cushion
		991236	Thrust Washer
		991227	Drive Adapter
115	Suzuki Outboards (30-70 HP)	991225	Urethane Cushion
		991239	Thrust Washer
		991231	Drive Adapter
116	Tohatsu/Nissan Outboards (35-50 HP)	991225	Urethane Cushion
		991241	Thrust Washer
		991227	Drive Adapter
117	Yamaha Outboards (40-60 HP)	991225	Urethane Cushion
		991243	Thrust Washer
		991227	Drive Adapter
118	Evinrude/Johnson Outboards (20-35 HP)	991225	Urethane Cushion
		991237	Thrust Washer
		991229	Drive Adapter
119	Honda Outboards (20-30 HP)	991225	Urethane Cushion
		991233	Thrust Washer
		991226	Drive Adapter
120	Mercury/Mariner/Force Outboards (18-25 HP)	991225	Urethane Cushion
		991235	Thrust Washer
		991228	Drive Adapter
121	Suzuki Outboards (25-30 HP)	991225	Urethane Cushion
		991238	Thrust Washer
		991230	Drive Adapter
122	Nissan/Tohatsu Outboards (25-30 HP)	991225	Urethane Cushion
		991240	Thrust Washer
		991226	Drive Adapter
123	Yamaha Outboards (20-30 HP)	991225	Urethane Cushion
		991242	Thrust Washer
		991230	Drive Adapter
<b>Gearcase Adapter Rings for 20-30 HP</b>		991244	Package including all three sizes



## Limited Lifetime Warranty

Michigan Wheel Corporation warrants to the original consumer purchaser that for the life of the motor originally fitted with the Michigan Match™, Vortex™, Rapture™ or Ballistic™ Propeller, under normal pleasure boat usage, the body of the propeller will be free of any defect in material or workmanship that results in blade or hub fracture or failure. Michigan Wheel Corporation also warrants to the original consumer purchaser, under the same parameters of use described above, that the propeller bushing will be free from any defect in material or workmanship for a period of one year from the date of purchase.

Some surface discoloration is unavoidable in a cast stainless steel alloy, and will not be covered by this warranty. This warranty also does not cover normal wear, accidental damage, modification, improper installation, improper maintenance, or other circumstances that are not the direct result of a defect in the material or workmanship of the propeller.

The sole obligation of Michigan Wheel Corporation under this warranty is to repair or replace the propeller, in the sole discretion of Michigan Wheel Corporation, and at its expense. In order to make a replacement claim, please contact the Michigan Wheel Corporation Customer Service Department, at (616) 452-6941, for a "Return Goods Authorization" number (RGA#), and shipping address instructions. The warranty will not cover any expense of propeller removal, shipping, or reinstallation of the propeller. The RGA# is to be indicated along with our given address on the label, and the shipping carton should include your return shipping address, your phone number, and your original purchase receipt.

The above warranty is Michigan Wheel Corporation's sole warranty for the Michigan Match™, Vortex™, Rapture™ or Ballistic™ Propeller. Michigan Wheel Corporation expressly disclaims all other warranties, expressed or implied, including, without limitation, the warranties of merchantability and fitness for a particular purpose and excludes all liability for incidental or consequential damages, loss of use of the propeller, costs, and expenses.

Any actions arising out of this warranty and the sale of this product shall be governed by Michigan law and may only be brought, heard and decided in Kent County Circuit Court, in the State of Michigan, U.S.A., or in the United States District Court for the Western District of Michigan.

Michigan Wheel Corporation  
Outboard & Sterndrive Division  
2685 Northridge Avenue NW, Suite G  
Grand Rapids, MI 49544  
Phone: (616) 452-6941

### Need your Propeller Repaired?

Congratulations, you have chosen a top quality propeller. Should it become damaged during use, you want a qualified trained technician to repair it. Contact the **National Marine Propeller Association (NMPA)** at phone: 616.235.6672, fax: 616.235.0144 or visit them on the web: [www.nmpa.net](http://www.nmpa.net) for a certified propeller repair shop near you.

Warranty claims are to be addressed directly to **Michigan Wheel Corporation** per instructions on this warranty statement and not to the **NMPA**.