

*How to get the most
from your ELTO*

ELTO Service Manual

For Models C and D

Complete with

Operating Directions

Instructions
for Care of Motor

List of
Parts and Accessories
with prices

ELTO OUTBOARD MOTOR COMPANY

OLE EVINRUDE, President

Milwaukee, Wis., U.S.A.

TABLE OF CONTENTS

Foreword	3	Using It on a Boat	4
Learn How to Start Motor Before		"Don'ts"	4

GENERAL OPERATING DIRECTIONS, Pages 5 to 19

Starting	5	Poor Boat Speed Due to Propeller	
Correct Method of Cranking (Il- lustrated)	8	Wheel Inefficiency	12
Priming	9	Different Types of Boats and Canoes	
Quick and Easy Starting	10	on Which the ELTO Light Twin	
What to Do When Motor Is		Can Be Used	12 to 14
Flooded	10	Treatment of Rowboats—An Ef- ficient and Practical Method of	
Carburetor Adjustments	10	Arranging Boat Transom (Il- lustrated)	16
Trolling Speed	11	Proper and Improper Depth of	
Automatic Tilting	11	Stern (Illustrating Results)	18
Speed of Motor Increases With			
Use	12		

POSSIBLE TROUBLES, Pages 20 to 27

Improper Gasoline Feed in Carbu- retor	20	Principle of Atwater Kent System	23
Obstructed Gasoline Flow	20	Loose Timer	24
Ignition Troubles and How to Lo- cate Them	20	Defective Coil	24
Battery Trouble	21	Functioning of Propello-pump	25
Defective Timer	22	Motor Choking and Stopping	25
Adjustment of Timer Points	22	Motor Pounding	26
		Motor Binding	26
		Shearing of Propeller Drive Pin	27

CARE OF MOTOR, Pages 28 to 33

Tilt Motor Out of Water When Not in Use	28	What to Do With Motor If It Has Been Submerged in Water	30
Where the ELTO Is Used in Salt Water	28	To Protect Battery From Short Circuit	31
Removing Motor From Boat	29	Proper Lubrication of Motor	31
Cylinder Jackets Are Self Drain- ing	29	Lubrication of Gears	31
Proper Position of Motor When Not in Use	29	Timer Needs No Special Lubrica- tion	32
Keep Flywheel Handle in a Forward Position	29	Add No Attachments to the ELTO Motor	32
Putting Motor Away for the Sea- son	30	How to Install New Thumb Screw Buttons	32
		Packing Motor for Re-Shipment	33

INSTRUCTIONS ON TAKING MOTOR APART, Pages 34 to 38

Upper Assembly—34 and 35—	Lower Assembly (With Illustrations)
How to Remove Flywheel.	35 to 38—
How to Remove Timer.	How to Remove Propello-pump
How to Remove Gasoline Tank.	(not illustrated).
How to Remove Coil.	How to Remove Drive Gear and
How to Remove Carburetor.	Thrust Washer.
How to Remove Cylinders.	How to Remove Drive Shaft Only.
How to Remove Pistons and Wrist Pins.	How to Remove Vertical Threaded Drive Shaft Bearing.
How to Remove Connecting Rods.	How to Adjust Propeller Shaft and Thrust Bearing.
How to Remove Crank Case and Crank Shaft.	

**COMPLETE LIST OF PARTS AND ACCESSORIES WITH PRICES—
ALSO INSTRUCTIONS ON "HOW TO ORDER," Pages 39 to 49**

F O R E W O R D

THE ELTO LIGHT TWIN is an excellent piece of mechanism. Its design is mechanically right, even to the smallest detail. It is built under conditions, productive of the highest results possible to obtain in outboard motor manufacture.

Through the fine mechanical ability of Ole Evinrude and his engineering staff, an unusually high standard of refinement, seldom attempted in gasoline engine building, has been attained. Fine modern gauges and tools confer a degree of accuracy not generally practiced, nor thought necessary in the building of outboard motors.

A rigid inspection system insures every ELTO buyer a motor which is in perfect running order when it leaves the factory. However, the owner must accurately follow the operating directions given in this book in order to enjoy to the highest degree, the efficient and dependable service for which the ELTO LIGHT TWIN was designed.

Learn How to Start Your Motor Before Using It On A Boat

WHILE not altogether necessary, we would nevertheless suggest to those not familiar with outboard motors and their operation, that they practice starting the ELTO before using it on a boat. This can be done by clamping the motor to a rack, bench or barrel, or anything available with which to answer the purpose and starting it according to the General Directions.

This will enable the user to acquaint himself with the general adjustments necessary for proper running, more conveniently than would be possible in a boat out on the water. The operating directions can be studied and followed more easily when the motor is started free from load.

In this way the motor can be run for periods of one or two minutes at a time, without water.

If the user becomes familiar with the adjustment and starting of his motor in this manner, running the motor on a boat will be a very simple matter.

ELTO PROPELLO - PUMP

The ELTO propello pump cools the motor perfectly, when motor is used on a boat. When used on a barrel or on a tank **SMALLER THAN 3 FT. SQUARE**, the propello pump will not function due to back pressure caused by running in such limited space. However the motor can be run for a minute or two, without harm, even though the water is not circulating.

DONT'S

- DON'T RUN MOTOR** if it is pounding. Look for the following probable causes:
- (1) Loose Flywheel Nut;
 - (2) Too Much Gasoline;
 - (3) Fouled or Dirty Spark Plugs, caused by too much or too heavy a Grade of Lubricating Oil;
 - (4) A Loose Connecting Rod.
- DO NOT REVERSE** motor on the spark at full speed. First slow it down on the gas throttle or better still, stop motor and start it in reverse position.
- DO NOT** run Motor **WITHOUT** lubricating oil mixed with the Gasoline.
- DO NOT** pour lubricating oil into Gasoline Tank. Mix it thoroughly in a **SEPARATE CAN** with the gasoline.
- DO NOT** use **MORE** than four ounces or one-quarter pint of good **MEDIUM** Grade Lubricating Oil to one Gallon of Gasoline, **HIGH-TEST**, if possible.
- DO NOT TIP** or leave motor in an **INVERTED** or "up-side-down" position, when not in Use.
- DO NOT ALLOW** battery posts to come in contact with any part of the motor. This will cause a "short-circuit".
- DO NOT** have "Friction Nuts" too loose; when motor is tilted, it will drop back heavily into place and is apt to damage bracket.
- DO NOT** tighten **THUMB SCREWS** with wrench or pliers. Use only **THUMB PRESSURE** to guard against breaking **BRACKET**.
- DO NOT** run motor without proper water circulation. If water does not flow from both outlet coil pipes, look for obstructions in **INTAKES**.
- DO NOT DROP MOTOR** suddenly to a side position when removing it from the boat. Lift it straight up and hold it for a few seconds until the water in the main casing runs out through the propeller wheel.
- DO NOT** neglect to wipe off and oil surfaces of motor every time it is removed from **SALT** water. This is necessary if you expect service from your motor.

General Operating Directions

STARTING—You will start and run your ELTO Motor with ease if the following directions are adhered to:

Mix gasoline (HIGH TEST, if possible) and high grade MEDIUM automobile engine oil in this proportion: 32 parts gasoline to one part oil, or $\frac{1}{4}$ pint oil to one gallon of gasoline. Shake thoroughly in a separate can and with this mixture fill the ELTO gasoline tank. (See "Proper Lubrication of Motor" Page 31). This will lubricate the entire motor with the exception of the gears. (For "Lubrication of Gears" see Page 31). Never run the motor without the proper amount of oil thoroughly mixed with the gasoline, for this will seriously affect the engine. Our guarantee will not cover injury to motor caused by lack of oil.

Before motor is put on the boat (or rack for preliminary trial) swing rudder into place. This is done by turning propeller to a vertical position, so that rudder may clear it, and then raising tiller yoke to which steering ropes are fastened, rolling the flywheel slightly and at the same time swinging the rudder until it clears propeller. See that it snaps securely into the slot.

Motor is now ready for the boat (or rack). After it has been hung over the stern and set in a true center position, tighten up the two thumb screws, but not with a wrench. (There is no vibration to shake the motor loose.) Slightly loosen nuts "A" and adjust screw "B". (See Fig. 7, Page 6). This adjustment permits motor to be swung to a general vertical position, from which it is then to be slightly inclined to allow the propeller to drive down into more solid water. (See Illustration, Fig. 13, Page 17). Then draw up the nuts "A" so that they are FAIRLY tight. (See "Automatic Tilting", Page 11).

Lay battery flat so that it will not fall over and damage connections. Remove the two black insulated binding post nuts (See Page 31, "Protect Batteries from Short-Circuit") and securely attach the coil wire spring terminals to the binding posts. These connections can be made on either the "positive" or "negative" posts of the battery and are interchangeable. It is advisable to alternate these battery connections as often as possible.

Open Cut-Out for starting as this will assist in determining whether motor is firing properly and running smoothly. The rod which controls the cut-out is located just above the friction clutch on the left, when facing motor, and is marked "K" (See Fig. 7, Page 6). It is to be raised up when opening cut-out.

Front View of Elto Motor

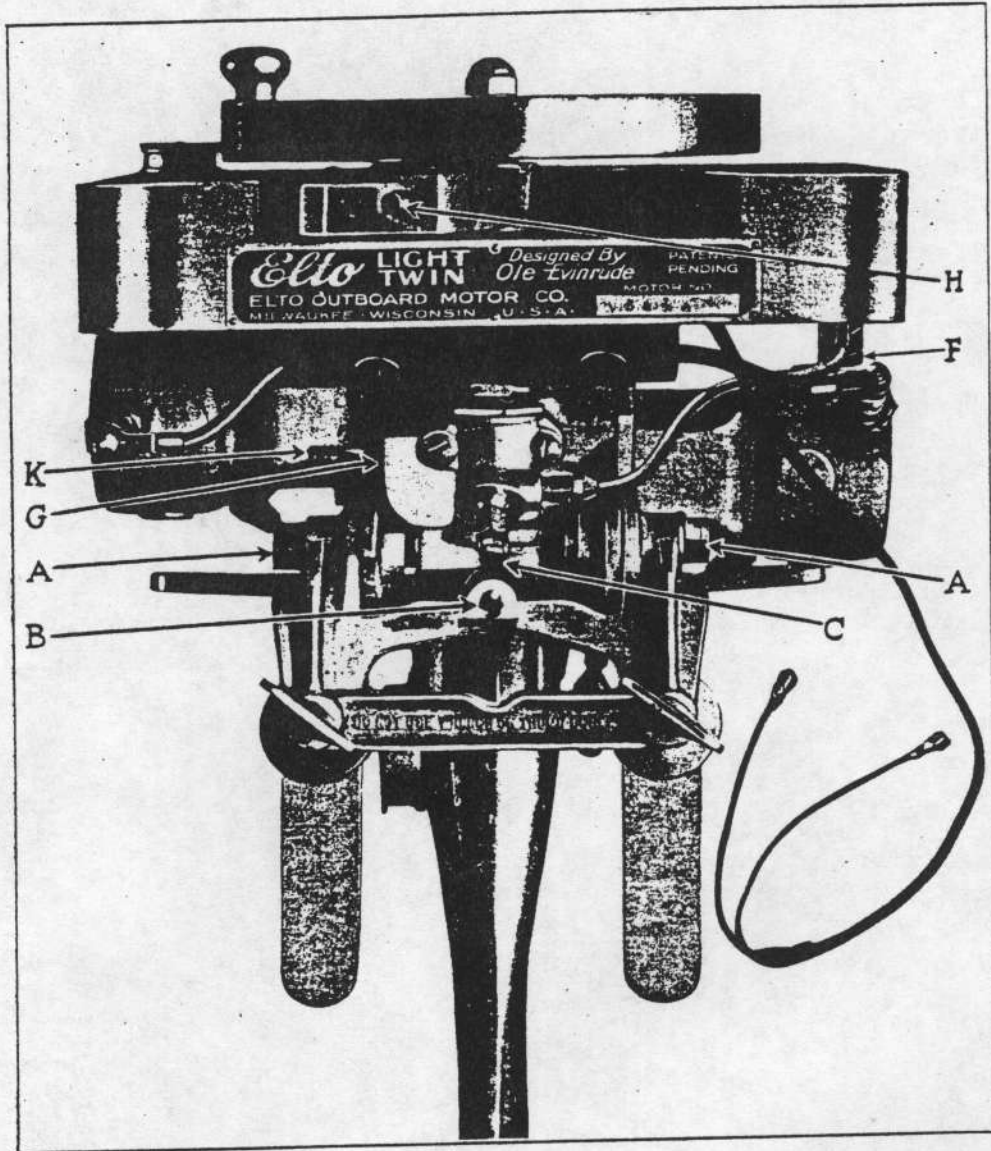

Fig. 7

Set Timer Lever to general position marked "Forward" on Fig. 8, below. This is the STARTING position only. After the motor starts the timer is to be advanced past center to the RIGHT to obtain full speed.

Open Gasoline Valve "C" one full turn, depending of course, upon the temperature. In other words, in cold weather, open it more, while in warm weather, a smaller opening will suffice. To determine whether the gasoline is feeding, lift up check valve stem below carburetor and hold for several seconds. If gasoline then drips from the bottom of carburetor, you will know the carburetor is feeding and this precaution saves unnecessary cranking. (See "Priming", Page 9).

Place flywheel handle to the back of the motor as indicated on Fig. 8, below, and rock flywheel back and forth a few times between the compression points, "A" and "B", as indicated. At the same time, hold

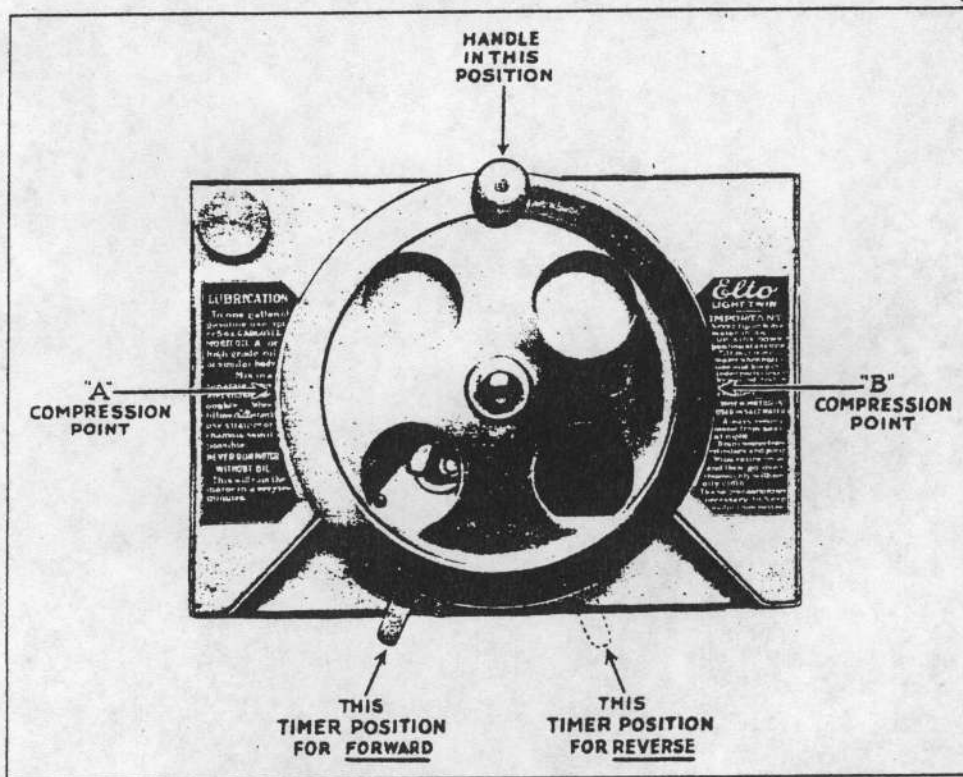

Fig. 8

two fingers across air opening "G" on the carburetor. This acts as a choke and helps in priming the motor, drawing a rich mixture into the crank case.

Then grasping the flywheel handle with the thumb and first two fingers as indicated on Fig. 9, Page 9, bring the flywheel up against compression "A" with a quick jerk, at the same time letting go of the handle. The motor will then take the retarded spark and will start forward. (See "Correct Method of Cranking Motor", below).

After Motor Starts quickly advance the timer lever or spark toward the right, past center. Motor will then speed up somewhat, but may run irregularly until it is warm. Gradually close gasoline valve "C" back to approximately $\frac{3}{4}$ to $\frac{1}{2}$ a turn opening or until the motor runs smoothly and fires regularly. The regulation of valve "C" is very sensitive and requires but a slight adjustment to attain the best running point. Of course, as the engine heats up, it needs less gasoline. (See "Carburetor Adjustments" Page 10).

To Obtain Full Speed advance the timer lever or spark to the extreme right, but not to the limit if motor pounds. When motor is to be slowed down, the timer or spark lever is then moved back to the left, or starting position.

To Stop Motor when in either forward or reverse direction, press stop button "H" on timer. Be sure and hold the button until the motor comes to a full stop. Otherwise motor is apt to reverse.

To Reverse Motor press stop button "H" and after motor has stopped, move timer lever or spark to the reverse side as indicated on Fig. 8, Page 7, and bring flywheel up against the opposite compression to the right or position "B", as shown. After motor starts in a reverse direction, advance timer lever toward the left to increase speed.

Water Circulation—After the boat gets under way and the motor is running smoothly, look around over the stern to the back of the motor to see if the water is coming from both the outlet coil pipes. If both pipes are discharging the cylinders are then being properly cooled. (See Page 25 "Functioning of Propello-Pump").

CORRECT METHOD OF CRANKING MOTOR (Illustrated on Page 9—Fig. 9)

It is very important that the operator learn the correct method of cranking. A little practice is necessary in most cases to obtain the right starting movement.

The Flywheel Runs Clockwise or to the Right for Forward. Although the motor can be started by throwing the flywheel over compression "B" to the right, this however, is not necessary with the ELTO, as it can be started with ease, by merely bringing the flywheel back against the opposite compression, or to position "A", with a quick

at the same time holding two fingers across the air opening "G" of carburetor. This will admit a rich priming mixture into the crank case.

The use of priming cups on the spark plugs, also the practice of removing the spark plugs to admit the use of gasoline, ether or other high combustibles, is unnecessary and not recommended.

After priming the motor in the above manner, it should start most readily when the flywheel is brought up against compression "A" with a quick jerk. The flywheel can also be thrown across compression "B" to the right, with a quick throw, in starting the motor when cold.

QUICK AND EASY STARTING

The ELTO Motor starts surprisingly easy, especially when it is warm. Therefore, after it has been run and is warm and is to be started again, NEVER rock the flywheel as you would do in PRIMING a cold motor, for this will flood the motor. Instead, move timer lever to the left or FORWARD position and then simply bring flywheel back against the opposite compression or to position "A" for forward (See Fig. 9, Page 9) with a quick jerk, letting go the flywheel handle. The same results will be obtained in reversing the motor, first moving timer lever to the right or REVERSE position and then bringing the flywheel back against the opposite compression or position "B" for reverse (See Fig. 8, Page 7).

WHAT TO DO WHEN MOTOR IS FLOODED.

Should motor at any time become flooded, close gasoline valve "C" and then bring the flywheel up against compression in the same manner as you would when starting the motor forward. This process admits fresh air to the crank case and after a few crankings in this manner, the motor will run a moment and then stop. Gasoline valve "C" should then be opened to the running point, when motor is warm, flywheel given a couple more quick jerks against compression and motor will start.

CARBURETOR ADJUSTMENTS

On the gasoline valve "C", you will find the best running point somewhere between $\frac{3}{4}$ to $\frac{1}{2}$ turn open when motor is warm. This will vary slightly on each motor and it is therefore, impossible to designate it with any definite marking at the factory.

The check valve is ground to a perfect seat in the carburetor and will not leak gasoline if needle valve is left open indefinitely. It is therefore, not necessary to close the valve "C" every time the motor is stopped, although it might be well to do so when the motor is not to

be used for over a half hour or more. Should valve "C" leak gasoline at any time through constant use, it can be tightened by drawing up on the brass hexagon stuffing nut. Do not use too much force in closing the gasoline valve "C" as this is apt to drive the needle point into the carburetor seat, springing it and causing the carburetor to leak.

Altitude Adjustment. The carburetor on the ELTO Motor is tested and set for use in altitudes up to approximately two to three thousand feet above sea-level. Where the motor is to be used in higher altitudes, it is necessary to increase the air lift of the check valve. To do this, it will first be necessary to remove the carburetor (See Page 34). The throttle screw against which the check valve hits can then be raised somewhat, by first loosening the small set screw which holds the clamp to this screw, then after moving the clamp to the right, clockwise, approximately a quarter turn, the set screw is again tightened. The clamp is then turned back to its original position. The throttle screw has a double thread and therefore, requires but a very slight adjustment to secure an increase in lift. **DO NOT DISTURB THIS AIR VALVE UNLESS MOTOR IS USED IN HIGH ALTITUDES.**

TROLLING SPEED

As a general thing a satisfactory trolling speed can be obtained with the ELTO Motor by retarding the spark lever to the extreme left hand position. There are, however, certain kinds of trolling which require still slower boat speed. For this purpose we furnish a trolling attachment as illustrated on Page 15, the price of which is listed on the inside back cover of the manual under the heading of accessories.

This attachment weighs only $1\frac{3}{4}$ pounds and it takes but an instant to slip it into place on the back of the rudder, where it is securely held by simply closing a small lever.

With this device the boat speed can be reduced to almost a "stand-still" and at the same time the motor speed will permit complete control of the boat. This is very desirable, especially when the operator is attempting to make headway against a quarter-wind. It is impossible to secure an accurate control of the boat under these conditions if the motor is throttled down to a point where it barely turns over. The fisherman will appreciate what this means, for if the motor stops his lines will go to the bottom and become fouled before the motor is again started and proper headway gained.

AUTOMATIC TILTING

Automatic Tilting of motor in striking obstructions is permitted by the proper adjustment of nuts "A". These nuts control the tension on the friction discs and when motor is running should be so adjusted as to allow motor to oscillate in hitting an obstruction. For this purpose they should not be drawn up too tightly. The same tension which permits motor to tilt when striking obstructions, will hold it securely in place when it is to be swung out of water for beaching, poling over shallows, etc. For running in reverse for any distance, nuts should be drawn up more securely.

SPEED OF MOTOR INCREASES WITH USE.

It is better for the motor not to be run at top speed at the beginning of its use.

All parts of the ELTO Motor are fitted so very closely and accurately throughout that a reasonable amount of time is required in which to "wear it in". Therefore, maximum results in speed and power may not be obtained for some little time. This applies to motors of any design.

If the user will be considerate of his motor in this respect, allowing it to gradually develop speed, pleasing results will be noticeable from day to day.

Where the user wishes to secure the utmost in speed, it will be found that opening the cut-out will increase the speed perceptibly.

POOR BOAT SPEED DUE TO PROPELLER WHEEL INEFFICIENCY

If motor is firing properly and running at a high rate of speed, the result of poor boat speed is then due, in most cases, to not having the propeller wheel submerged deep enough (See Fig. 10, Page 18). Better results can be obtained by CUTTING or NOTCHING the stern of the boat a few inches, bringing the motor down lower and permitting wheel to drive in solid water. (See Fig. 11, Page 19).

Especially where flat bottom boats are used, the propeller wheel should be submerged until the top of the blade is below the bottom line of boat, as shown on Fig. 11.

Full efficiency of wheel cannot be obtained otherwise, as the water directly behind a boat of this type, is not solid, but is in a constant swirl or vortex, when boat is under motion. Unless the wheel is well below this disturbed water, it will therefore, slip or race.

Another important reason for poor boat speed is in most cases, due to not having the boat properly trimmed, that is, not on an even keel. If the boat is so loaded that it squats at the stern, this will then throw the bow out of water and will naturally retard the speed. Many varying effects as to speed can be noted in the manner of properly distributing the boat load.

Different Types of Boats and Canoes on Which the Elto Light Twin Outboard Motor Can Be Used.

ROUND, FLAT OR "V" BOTTOM BOATS

The ELTO, due to its light weight and extremely smooth performance, can be used on the very lightest of boats. Therefore, when the selection of a boat is being made for the ELTO, we would recommend that one of light construction be chosen.

By far the best results all around, are obtained with light, round bottom boats, either "clinker built" or "smooth planked" 14 to 16 ft. in length by approximately 4 ft. beam. However, boats 18 to 20 ft. in length can also be used, although not as good results will be obtained as with the smaller types. Any depth is suitable, as in most cases this varies according to the construction.

A good flat or "V" bottom boat of the above dimensions is also suitable for the ELTO, although we again recommend the lightest construction possible. A light boat not only means more speed but easier handling in beaching, making portages, and in other ways.

Boats that are built purposely for ordinary outboard motors, are generally constructed along those lines which will enable them to withstand the motor's excessive vibration. Such boats are made with a very heavy transom, heavy corner braces as well as extra braces and ribs throughout the entire boat. Furthermore their design calls for an unusually wide stern, in order to withstand the excessive weight of the motor. This weight, together with the action of the propeller wheel, would cause a boat with a narrow stern to "squat" or be drawn under, thereby throwing the bow of the boat out of water and retarding the speed considerably.

The ELTO, however, does not need a boat with an unusually wide stern and we recommend one of more graceful lines whose bearing or width of stern is just enough to offset the action of the propeller wheel.

Flat bottom boats are not so desirable for inland lake use, as they pound considerably when running in a "head-sea."

POINTED STERN OR DOUBLE END ROWBOATS

By the addition of a special bracket, the ELTO can be used on pointed stern or double end rowboats, however the best results cannot be obtained with this type of boat. Because there is no bearing at the stern, the action of the propeller wheel causes the point to "squat" and be drawn under, raising the bow out of water and retarding the speed.

Also because of the construction of most double end boats, the point on which the bracket must set is somewhat higher than the transom of the average square stern boat. This height, together with the addition of 3 inches or 4 inches necessary for the special bracket, does not allow the propeller wheel the proper driving depth. However, if the boat is somewhat lower than usual, it is possible for the motor to be used by the addition of this bracket.

We can furnish a special aluminum bracket for this purpose. (See Accessories, Inside Back Cover.)

THE STEEL BOAT

The ELTO motor can be used to good advantage on a steel boat. This type of boat is most sturdy and is generally light, offering very little resistance to the water. Consequently it is exceptionally speedy. The steel boat is becoming very popular. Several prominent boat builders are now building them. One of its chief advantages is the absence of seams. The steel boat is also built with compartments or air tanks on both ends, of sufficient capacity to keep the motor and boat afloat, should the boat become swamped.

SECTIONAL STEEL BOATS AND FOLDING CANVAS BOATS

The ELTO Motor can be used successfully on either a sectional steel boat or a folding canvas boat. This is made possible through its extremely light weight and smooth operation, as well as its automatic tilting device. Boats of these types, while not recommended for general use, are often preferred by the tourist and camper because they can be folded and nested and quite conveniently packed with their equipment.

CANOES

While the ELTO Motor can be installed in a double end canoe according to the popular method of installation—through the construction of a "well" in the canoe—we do not recommend its use in this manner as practical for several reasons—chiefly, because it cannot be used in shallow water, and furthermore, because it does not provide the necessary protection for the propeller wheel. It is also impossible to properly beach the canoe on account of the propeller wheel protruding through the bottom.

On large double end canoes it is possible to construct a bracket to which the ELTO could be clamped, although this method of attachment is not as practical as it might be, as it brings the motor too far away from the operator to be conveniently handled.

The most practical canoe for ELTO use and one which we highly recommend, is the "square stern canoe." This type of canoe is becoming very popular among sportsmen and is rapidly coming into general use. The square stern canoe is pointed at the bow only, and has a stern similar to a rowboat, to which the motor can be clamped. A canoe of this type with an ELTO Motor can be used in water deep or shallow and it also permits the ELTO'S tilting device to come into play, which in turn, fully protects the propeller wheel.

A square stern canoe with an ELTO makes an ideal outfit for use in waters where portages are frequently necessary, as it takes but an instant to remove the motor, thus lessening the weight of the outfit, which, of course, is not possible with a motor installed in a canoe.

All prominent canoe builders are now making square stern canoes, furnishing them in several styles and lengths, also with or without sponsons. We would recommend either a 16 or 18 ft. canoe where it is to be used with the ELTO LIGHT TWIN. The sponsons add somewhat to the weight of the canoe and although they afford great protection, they are not so necessary where the canoe is to be used on streams, but very desirable in use on open water. A "sponson canoe" is fully, if not better able to withstand rough weather conditions than most rowboats.

APPLICATION OF THE ELTO TO LARGE BOATS OR BOATS ON SWIFT STREAMS

On exceptionally large and heavy boats, or on any boat used on streams where a swift current is encountered, two ELTO Motors can be used effectively, producing a twin screw effect. This method, while not increasing the speed of the boat to any great extent, will considerably increase the power, which is necessary to make headway against swift currents.

Two motors mounted on the same stern, however, require left and right hand propeller wheels. The right or "starboard" motor must be equipped with a right hand propeller wheel as this is the motor to be run in a reverse direction. Two left hand wheels will not permit the proper results as the action of one wheel interferes with the other, causing the boat to take a diagonal course. The use of two motors also necessitates the coupling of both rudders in order to secure a uniform control in steering. The regular ELTO wheel is of the left hand type but we can furnish right hand propeller wheels for double motor use.

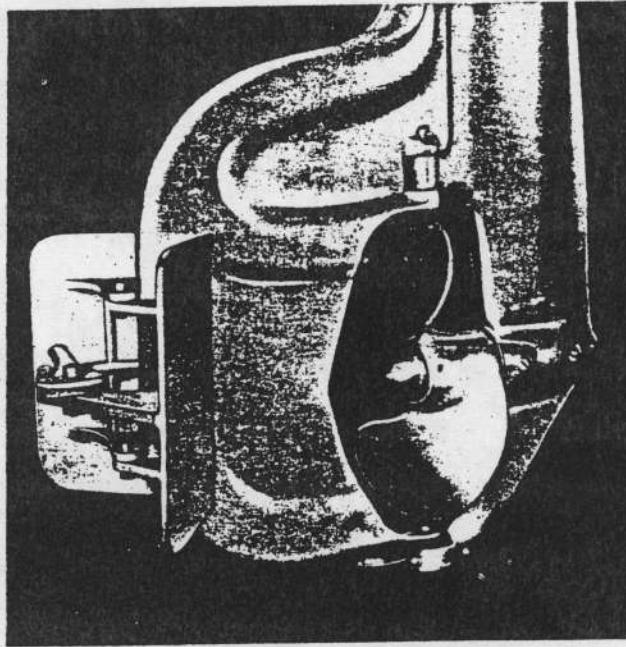

TROLLING ATTACHMENT

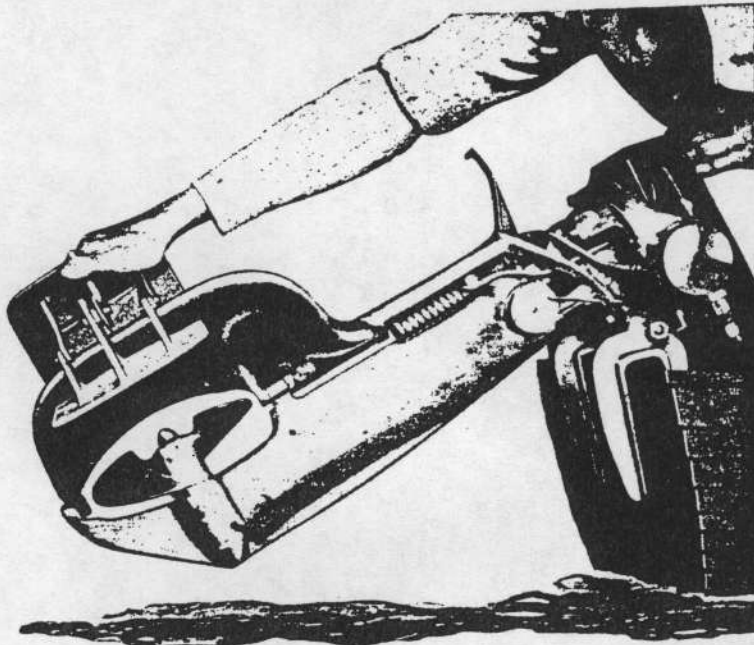

EASILY ATTACHED AND REMOVED

Treatment of Rowboats

An Efficient and Practical Method of Arranging the Transom or Stern of a Rowboat for the Elto Light Twin Outboard Motor, to Obtain the Maximum Power and Speed

Figures 12 and 13 illustrate the treatment of a rowboat, unusually high in the stern, so that the best results can be obtained from its use with an ELTO Motor. The drawing represents the ELTO used on a

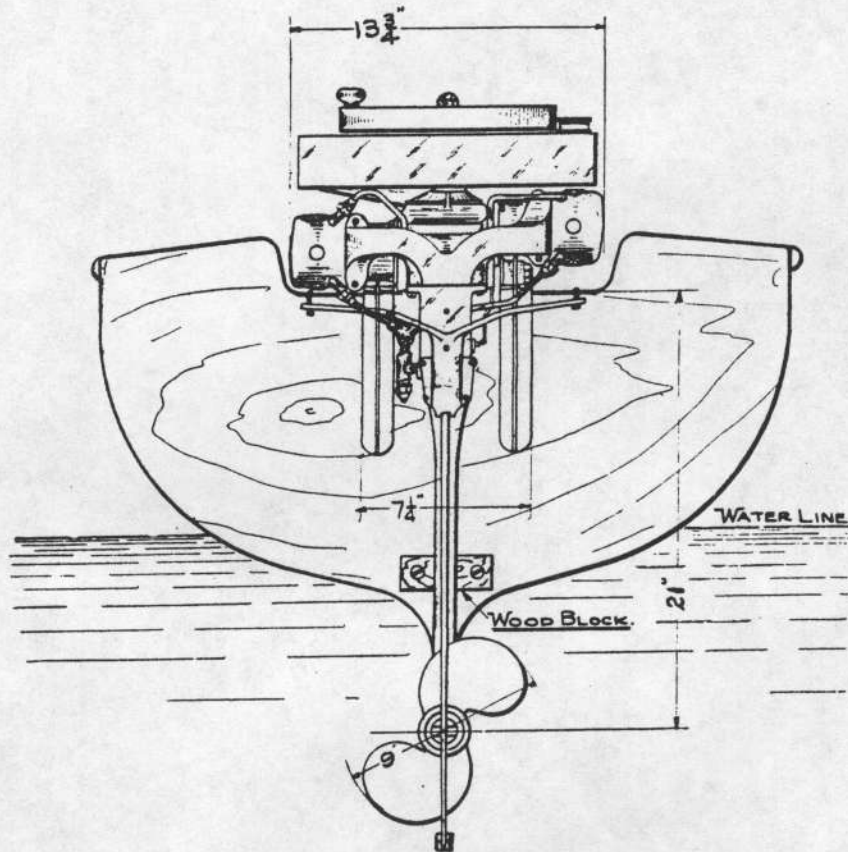

Fig. 12

rowboat of the round bottom type. The boat has been notched or "cut down" approximately 3 inches deep by 15 inches wide, and a permanent place made for the motor to fit into.

The advantages to be derived are these:

FIRST—The propeller wheel is lowered to the proper depth, making possible the most efficient drive.

SECOND—A more rigid drive is secured by bringing the motor down as low as possible, and this also decreases the strain on the transom.

THIRD—A permanent place for the motor is established on the boat, one which brings it always into a true central position with the keel, and equalizes the rudder control.

While the sketch shows the boat transom cut down about 3 inches, this depth is not necessary on all boats, but will vary according to the depth of the stern. It is always best to permit the propeller wheel to drive into solid or undisturbed water. The best results are ob-

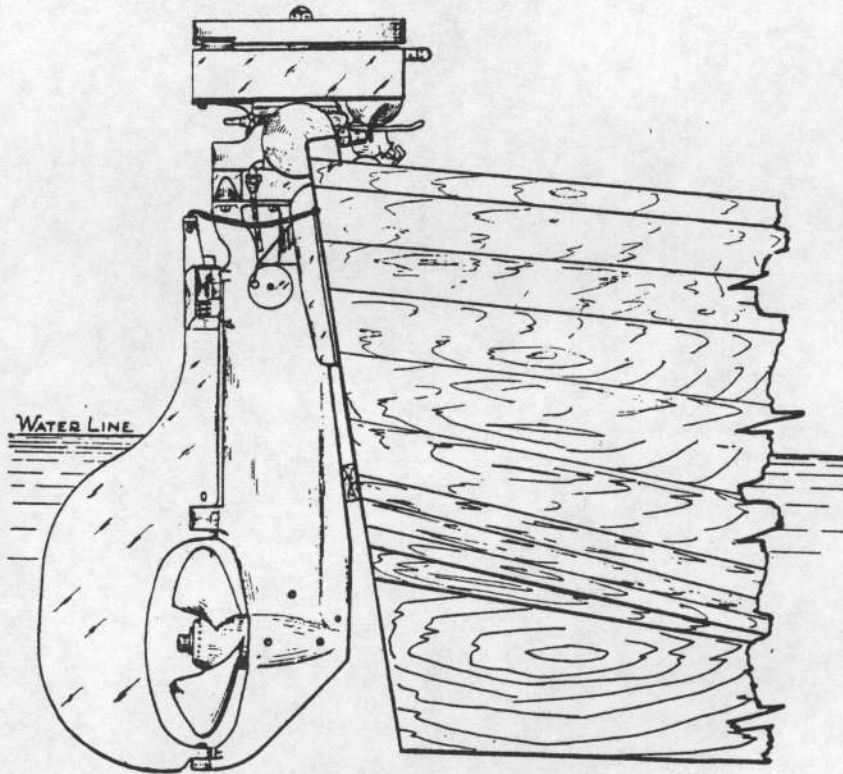

Fig. 13 (Side View)

tained by slightly inclining the motor, as shown on the sketch, for this will permit the propeller to drive down into more solid water.

It is also well to screw a small wood block onto the boat, as illustrated, against which the main lower casing will rest, thus relieving the drive shaft and transom of the strain caused by the action of the propeller wheel vibration.

Showing IMPROPER Depth of Stern, Resulting in Propeller Inefficiency

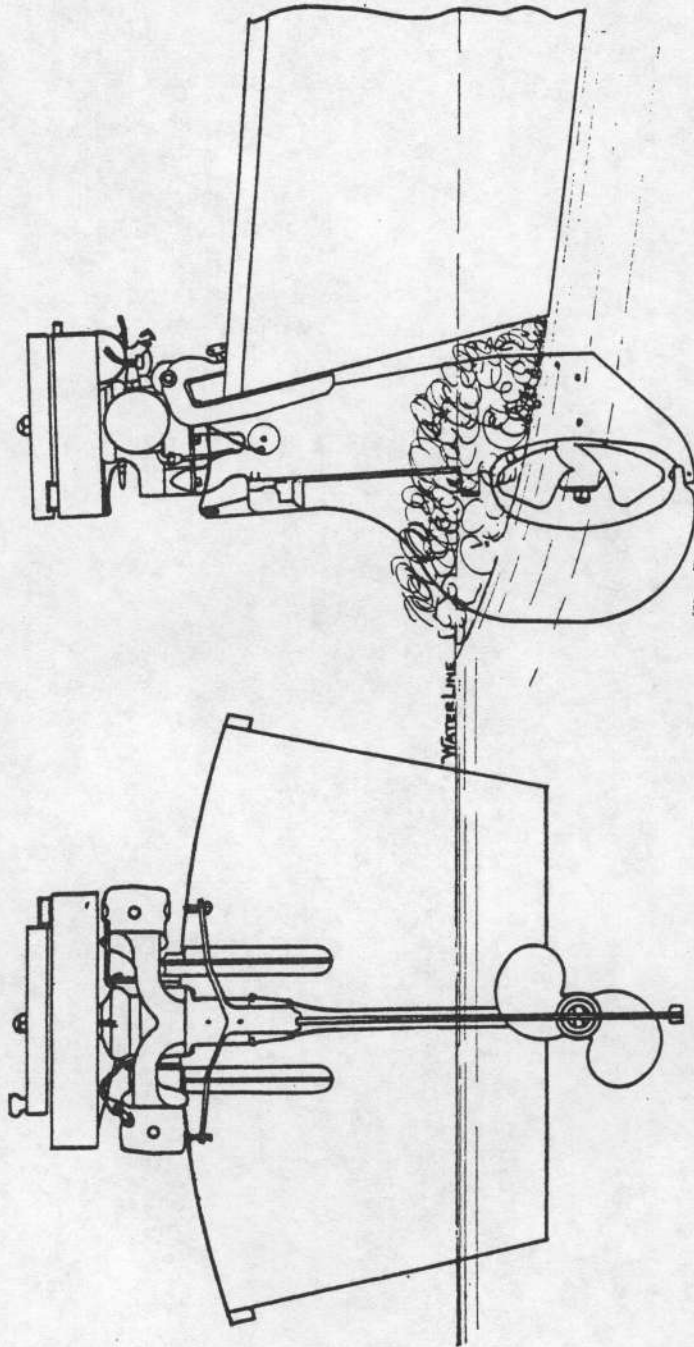

Fig. 10

In order to obtain perfect results from the ELTO Motor, the stern of the rowboat on which it is used, should not measure more than 17 inches to 18 inches in depth, especially when the stern is almost straight. Where the stern has quite an angle it can be somewhat deeper. As shown on Fig. 10, when motor is attached to a boat with a deep stern, part of the propeller wheel is shut off from solid water at the bottom line of boat, and thereby churns the water to a mass of foam, forming an "air pocket" at the back of the boat. This results in much disagreeable vibration from the propeller wheel. A motor running in this manner will be only half efficient, developing far from its maximum power and speed. Using the motor under these conditions may not so affect it at low speed, but as soon as the motor is accelerated the action of the wheel pulls the water away from the back of the boat and churns it into air bubbles.

Showing PROPER Depth of Stern Necessary to Obtain Best Results

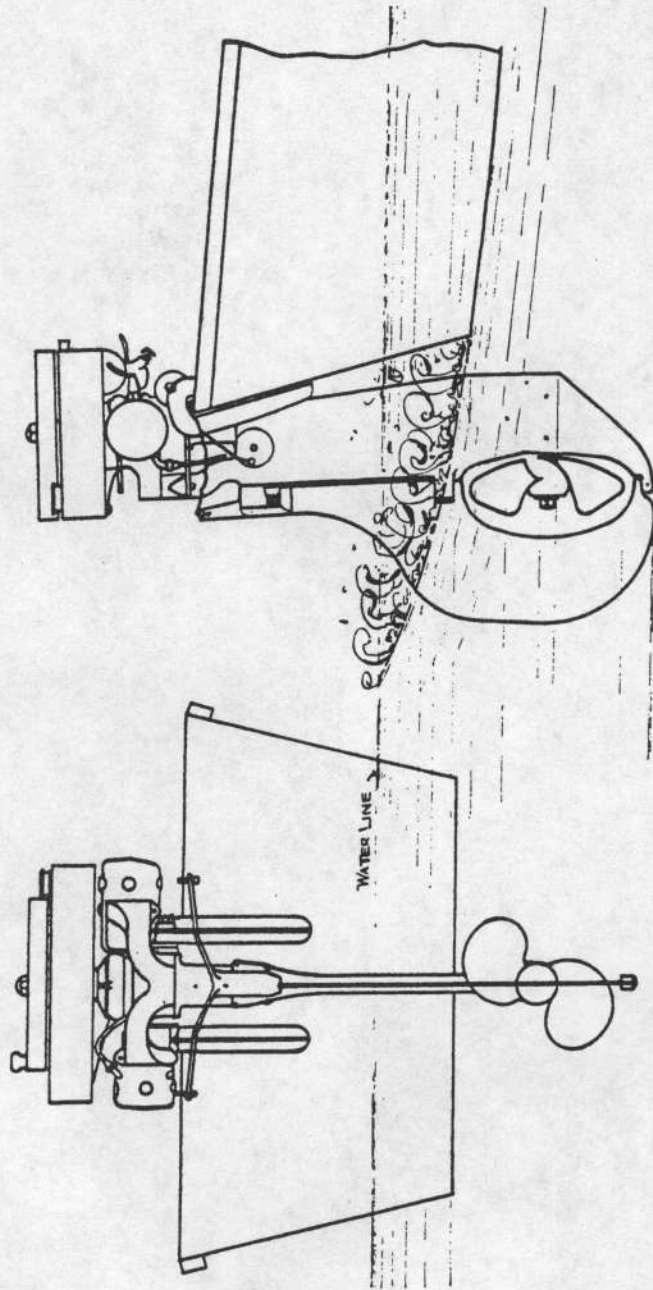

Fig. 11

The sketch above, or Fig. 11, shows the top of the propeller wheel in line with the bottom of the boat, giving it solid undisturbed water in which to drive. It is a simple matter to cut down the stern of a rowboat according to Fig. 11, should it be too high for proper results.

Possible Troubles

IMPROPER GASOLINE FEED IN CARBURETOR

Will the user just bear in mind when his ELTO gives him trouble: that there is positively nothing to keep a mechanically perfect gasoline engine from starting and running if gas is feeding properly and a good spark is available. So, if his motor refuses to start (after following operating directions explicitly) investigate the gasoline feed in this manner: open gasoline needle valve "C" two or three full turns and raise up on the check valve under carburetor to determine whether or not the gasoline has a good free flow. Fine particles of dirt may have gone through the dirt trap strainer and become lodged either in the feed pipe or in the small feed hole in the carburetor seat. This would interfere with the full flow of gasoline. The remedy for this is to remove the gasoline filler cap, place your mouth over the opening and blow forcibly into the tank, at the same time holding up the carburetor check valve and with the gasoline needle valve "C" open several turns as stated above. This added pressure in the tank will force the gasoline through the feed pipe and will remove the sediment.

OBSTRUCTED GASOLINE FLOW

It is well to remove the gasoline strainer plug "F" (See Fig. 7, Page 6), quite frequently and clean the dirt trap screen. If this is not done, dirt in time will so clog this trap as to shut off the flow of gasoline to the carburetor.

IGNITION TROUBLES AND HOW TO LOCATE THEM

Dirty Spark Plugs—If gasoline is found to be flowing freely and motor still refuses to start, the spark is evidently at fault.

After testing each motor, it is lubricated generously at the factory before shipment to keep the inner parts from rusting, especially during long periods of transit. Therefore, the plugs are apt to foul quite readily until this surplus oil is burned out and it will be necessary to remove them frequently and clean them thoroughly.

A defective or fouled plug can be determined very quickly by feeling of the cylinder heads after motor has been run for a short time. The cylinder in which the plug is not functioning properly, or not at all, will feel cold or not as warm as the cylinder in which the plug is performing as it should. The fouled plug should then be cleaned thoroughly or the extra plug used, which is furnished with the motor. A defective spark plug is in most cases, caused by the porcelain becoming cracked in some manner. To get the best results the spark gap at the points must be $1/32$ " apart. Be sure that the spark plugs are screwed into the cylinders securely, at all times, and that they have

the copper gasket on them. The spark plugs furnished with the ELTO are known as the metric size. This is a plug of standard measurement and any make of this size can be used.

How to Test Spark—To determine whether motor is getting the proper spark, remove both spark plugs. Connect wires to battery terminal posts and then hold one of the spark plug terminals to the cylinder, or ground it to any metal part of the motor, and holding the other wire about one-half inch away from the cylinder, turn the flywheel around slowly. This action should produce a spark at every revolution. If no spark whatever is apparent the cause is due to one of the following defects: Weak or damaged batteries, defective timer, or defective coil.

BATTERY TROUBLE

Weak or Damaged Batteries—This trouble is evidenced by motor refusing to start readily and also by its missing fire. If all is right, the spark should jump from $\frac{1}{2}$ " to $\frac{3}{4}$ " from wire terminal to cylinder when testing spark according to the directions in the foregoing paragraph. A spark measuring less than this is a proof of weak batteries.

The batteries furnished with the ELTO are all thoroughly tested before they leave the factory. No battery is sent out measuring less than 25 to 30 amperes. They are carefully packed and if received in good condition, should give no trouble. However, should they show any evidence of having been damaged, it is well to have them tested. The batteries used with the ELTO are commonly known as "dry cells". They are put up in units of four cells and are enclosed in a WATER-PROOF container, well insulated. Different makes of batteries are now put up in this way, and in renewing the batteries, any of them can be used. Four or five ordinary dry cells, or even a SIX VOLT storage battery, can also be used if a waterproof battery is not obtainable.

The batteries furnished with the ELTO ought to last a full season or more. Before "playing out" they will give ample warning, for when they are commencing to run down the engine will miss occasionally, and if you continue to run the motor this missing will become more pronounced—evidence that the batteries need replacing. However, they will not "die" suddenly and, although in a weakened condition, if allowed to "rest" a while, will pick up again. They will continue to do this for quite some time before they are entirely used up. Furthermore, when batteries reach this weakened condition and you are not able to replace them at once, the spark can be intensified by reducing the gap a trifle on the spark plugs; in other words, by bringing the points closer together. Never allow battery posts to come in contact with any metal. This would cause a "short circuit" and run the batteries down in a very short time. When putting the battery away after use, see that the black insulated terminal nuts cover the binding posts, which will protect them from becoming short circuited in any way.

Temperature Effect on Dry Cells—The effect of different temperatures on batteries is very noticeable and should be taken into consideration in testing them to determine whether or not they are defective, particularly so when batteries are shipped a great distance and are in transit for a long period. Extreme temperature has a marked effect upon them. At zero a battery will show only 10 amperes, while at 80° it will register normally, or 30 amperes.

Do not test batteries while they are cold. Before testing put them in a moderately warm room for 24 hours. Normal current may be expected when the temperature of the cell is normal or about 70°. The lowering of the current by low temperature does not injure a cell. The condition is only temporary and the current will be restored when the cell is warmed.

Do not store dry batteries close to steam pipes or in a hot room. Batteries keep better when they are cold, but should be used, if possible, while at normal temperature.

DEFECTIVE TIMER

The timer mechanism consists of the well known Atwater Kent Unisparker. Its initial adjustment made at the factory should be good for several seasons of ordinary use.

The lifter in the timer mechanism trips at every revolution of the flywheel, giving a sharp "click" or "snap" (See Figs. 1 to 4, Page 23). To determine if timer is in perfect condition turn the flywheel by hand and if this sharp "click" is not heard it is a clear indication that the timer needs repairing. If no Service or Repair Shop familiar with the Atwater Kent ignition is available, take off the complete timer box and send it back to us for repair. The inexperience of the so-called "expert mechanic" with this type of ignition and its extremely fine adjustment is very apt to ruin it entirely, and we advise the user to avoid this source of additional trouble and expense and return the timer to us.

It is also possible that the timer might in some way become water-soaked and the points corroded or rusted. The timer points are so extremely delicate, making necessary such very careful adjustment that we again caution the user against having the adjustment made anywhere but at a recognized Atwater Kent Service Station or a Repair Shop familiar with this system of ignition.

ADJUSTMENT OF TIMER POINTS

The contact points are made of purest tungsten, which is many times harder than platinum iridium.

When contact points are working perfectly, small particles of tungsten will be carried from one point to the other, sometimes forming a roughness and a dark gray color on their surfaces.

This roughness does not in any way affect the proper working of the points, owing to the fact that the rough surfaces fit into each other perfectly. However, when it become necessary to take up the distance between these points due to natural wear, it is advisable to

remove timer (See Page 34, "How to Remove Timer"). Also remove eccentric strap and timer cover, and then the contact spring, and with a new fine file dress down the high spots. Remove shim washers from under the contact screw head until the gap between the points is correct, or .010" to .012", never closer. This makes it possible to obtain a more accurate adjustment and eliminates any danger of high points on either contact touching each other when system is at rest.

Please bear in mind that these contacts are very hard to file, and that it is necessary to remove only a very small amount of metal. Please also remember that although the contact surfaces may be very rough they are probably in perfect working condition, the dark gray appearance being the natural color of the tungsten.

THE PRINCIPLE OF THE ATWATER KENT SYSTEM

The function of the Atwater Kent System is to produce a single hot spark for each power-impulse of the motor, accurately timed to occur at the right instant to procure the greatest possible power and efficiency. Its mechanism is very simple.

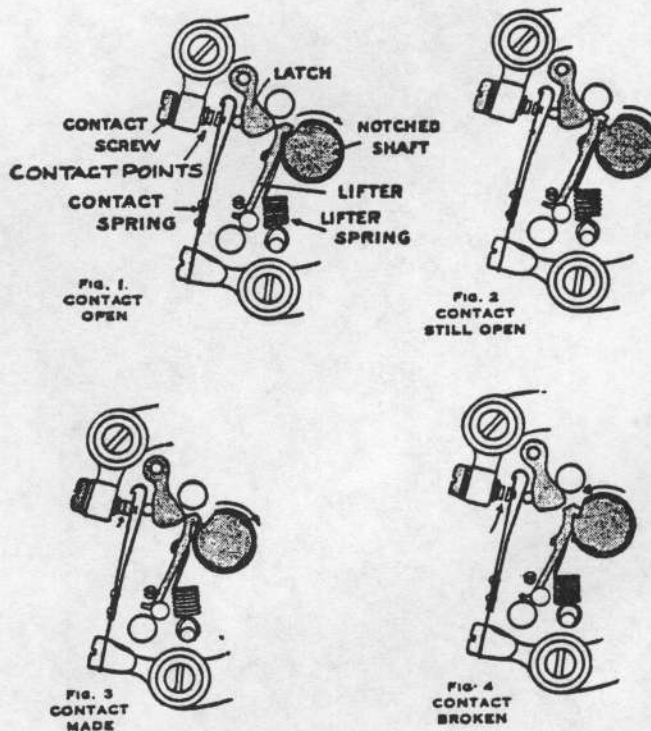

The Atwater Kent Type K-3 is different from other types of battery ignition in that the contact points DO NOT TOUCH except during the brief instant of the spark. The ignition circuit is therefore, normally open and no current flows, even though the ignition switch be

left "closed". The operation of the contact maker is shown on page 23. This consists of a pair of contact points, normally open, which are connected in series with a battery and the primary circuit of a simple non-vibrating induction coil. The mechanism for operating the contacts consists of a notched shaft which rocks at engine speed; a lifter or trigger which is pulled forward by the rocking of the shaft and a spring which pulls the lifter back to its original position after it has been drawn as far as it will go by means of the notched shaft. A hardened steel latch, against which the trigger strikes on its recoil and which in turn operates the contact points completes the device.

Figures 1, 2, 3 and 4, show the operation of the contact maker very clearly. It will be noted that in Fig. 1 the lifter is being pulled forward by the notched shaft. When pulled forward as far as the shaft will carry it (Fig. 2), the lifter is suddenly pulled back by the recoil of the lifter spring. In returning, it strikes against the latch, throwing this against the contact spring and closing the contact for a very brief instant—far too quickly for the eye to follow the movement (Fig. 3).

Fig. 4 shows the lifter ready to be pulled forward again by the notch.

Note that the circuit is closed only during the instant of the spark. No current can flow at any other time, not even if the switch is left "ON" when the motor is not running.

Note that no matter how slow or how fast the shaft is rocking, the lifter spring will always pull the lifter back at exactly the same speed, so that the operation of the contact, and therefore, the spark, will always be the same, no matter how fast or how slow the engine is running. The contact points are adjustable only for normal wear. All other parts of the contact maker are of glass-hard steel and are not subject to wear. If occasionally oiled they will outlast the motor because they move but a very short distance, do very little work and all friction has been reduced to a minimum.

LOOSE TIMER

Should the timer become so loose that it will not remain in a set position, it can be tightened by moving it to the extreme right side and drawing up set screw. This screw presses on a small fibre plug which in turn presses against the upper crank case bearing.

DEFECTIVE COIL

Very rarely is the ELTO coil a cause for trouble. It is known as the "Jump Spark" type and has no vibrator. It is possible, however, that the wires through careless handling may have become loosened from their connections. When ignition trouble is at hand, it is well to examine the wires to see that they are intact.

To test the coil after first determining that battery and timer are in good condition, connect the spring terminals to the battery binding posts. Then, after removing the timer cover, (See Page 34, How to Remove Flywheel), the primary circuit of the coil can be "shorted" or closed by taking a small piece of wire and touching the two binding

posts to which the coil wires are attached within the timer. By holding the wire on one of these connections and quickly touching the other connection for a second, a one-half inch or better spark should be produced at the secondary or spark plug terminals.

This is a positive manner of determining whether the difficulty is due to a defective coil or whether it is due to a defective timer. If no spark is produced in this manner, it is then evident that the trouble is in the coil, as the "shorting" at these points has the same effect as the contact produced by the timer points, when motor is running.

Do not attempt to substitute any other make of coil for that furnished with the motor as this coil has been especially designed for the ELTO. Furthermore, it contains the condenser for the primary circuit. The coil is heavily insulated and is strictly waterproof and substantial in construction.

FUNCTIONING OF PROPELLO-PUMP.

The ELTO'S Propello-pump cools the cylinders perfectly at all engine speeds. It is important, however, to accelerate the engine speed a little when starting, in order to force the water quickly through the jackets. As soon as the water is circulating and discharging from both outlet coil pipes, the engine speed can then be regulated as desired.

If outlet coil pipes fail at any time to discharge water, the pump pressure should be increased by advancing the timer. If this increased speed does not produce a discharge of water at the pipes, it is probable that either of the intakes are clogged. The motor can be easily tilted out of water and obstruction removed.

The screen or grating which is placed across the two intakes will keep sticks and weeds from entering the pump system. Any sand or dirt which washes past this grating will be carried through the system and discharged.

The absence of check valves in the ELTO'S water cooling system, and consequently any moving parts, completely eliminates all mechanical pump troubles.

The propello-pump is also self-draining. As soon as the motor is stopped, the water recedes or runs back through the intake pipe, automatically draining the cylinder jackets.

The propello-pump system does not function when the motor is running in a reverse direction, but this is of no consequence, as we absolutely guarantee the motor's operation for any reasonable length of time in the reverse direction without water, with no damaging results.

MOTOR CHOKING AND STOPPING

This condition is very often due to closing the cut-out or else rapidly shifting timer from full speed to retarded position, while running on a very lean mixture. If the gasoline needle is opened a trifle further it will be noticed that motor will not choke in this manner.

MOTOR POUNDING

If motor pounds at any time it is well to examine the flywheel nut to determine whether it is drawn up tightly. This nut must be drawn up securely at all times. If it becomes loose, it will be but a short time before the keyway in the crank shaft is severely damaged or flywheel hub cracked.

Loose Connecting Rod—If the flywheel nut is secure and the pounding continues, it is possible that a connecting rod is loose. The motor should be taken down at once and rod tightened, for if allowed to run in this condition the rod would soon be ruined. Only those experienced in the construction of gasoline engines should be permitted to make this adjustment.

MOTOR BINDING

Rusted Cylinders and Pistons—If motor turns over very hard and seems to be tight or stiff when flywheel is rocked between the compression points, this indicates that possibly the cylinders and pistons are rusted. To further determine whether this rusted condition exists, remove the spark plugs and if motor still turns over hard and is very stiff there is no doubt that the cylinders and pistons are rusted. If the condition is not too serious, the owner can remedy it by removing both spark plugs and injecting a little kerosene in the spark plug holes, rolling the engine around to permit the kerosene to work into the rings. Before doing this, however, see that the flywheel handle is in line with either of the cylinders, thereby keeping the exhaust ports closed. Let the kerosene remain in the engine over night or at least for a few hours and then follow up with plenty of lubricating oil injected into the cylinders. When the motor has loosened up sufficiently to enable you to revolve the flywheel, do so rapidly, at the same time squirting lubricating oil into the air intake of carburetor, where it is then drawn into the crank case and lubricates the crank pin bearings.

Tight or Cut Bearings—If the stiff or tight condition of motor described in the foregoing paragraph is apparently not caused by rust in the cylinders and pistons, another likely cause would be tight or cut crank shaft bearings. This can be determined by removing the exhaust manifold to see if the pistons and rings are well lubricated, and if they are found to be so, it is possible that the tightness is either in the upper or lower crank shaft bearing, a condition caused either by not enough lubricating oil used in the gasoline or through sand or grit finding its way into the crank case through the carburetor. If this stiffness occurs in a new motor or in one which has been run but very little, and if the stiffness is also in the upper bearing, it is possible to remedy it by removing the flywheel (See Page 34, "How to Remove Flywheel") and in squirting lubricating oil down through the crank shaft keyway, at the same time slipping the flywheel back on temporarily, so that the crank shaft can be rocked and lubricating oil thereby worked into it. This performance should be repeated several times until plenty of oil is worked down through this bearing.

If, however, the lower bearing is dry or cut, it will be necessary to remove the entire lower main casing in order to smooth and lubricate the crank shaft and bearing. To do this, it will be necessary to disconnect the exhaust manifold, the connections to the cylinders and also the cut-out lever, by pulling it out of the cut-out. Then, after taking out the four cap screws which hold the casing to the crank case, the entire lower assembly can be removed by placing a block of wood against it and hitting lightly with a hammer. If the bronze bearing in the lower casing is badly cut, it should be scraped with a proper tool or else should be reamed. (See Page 34.)

SHEARING OF PROPELLER DRIVE PIN

The propeller and also the gears are protected through the use of a drive or safety pin, which will shear or break off, should the wheel strike an obstruction. This will be evidenced by the motor speeding up or racing and the boat stopping. This safety pin is of soft brass $7/32$ " in diameter and will shear instantly, thus affording protection to the wheel and gears. It takes but a few minutes to remove the portions of the sheared pin and add a new one.

First remove the propeller wheel nut, which acts as a retaining cup for the pin. The propeller wheel is then turned until the holes in the hub are in line with the indicating mark on the end of the shaft. After lining up the holes in this manner, the sheared pin can be driven out with the aid of a punch or nail. The punch or nail is then used to line up the holes in the wheel and shaft and the new pin can then be inserted.

When renewing the propeller pin, be sure that it fits flush in the propeller hub. If the pin is allowed to protrude, it will break the cup on the nut as it is being drawn on. If no safety pins are on hand, an ordinary nail will suit the purpose temporarily, although for maximum protection a BRASS pin should be used.

Care of Motor

TILT MOTOR OUT OF WATER WHEN NOT IN USE

If the owner will use the ELTO tilting device freely, raising the motor out of water when not in use, instead of leaving it submerged he will find that this will do much toward keeping his motor looking well. The canvas hood which is sent free of charge upon return of the registration card, properly filled out, should always be used to protect the ELTO, especially in rainy weather and at night when the air becomes damp.

WHEN THE ELTO IS USED IN SALT WATER

It has been unquestionably proven by hundreds of owners that this motor affords many years of most dependable and efficient service if given the proper care and protection. By this is meant that first of all, motor should **always** be tilted out of water when on the boat but not in use. At night the motor should **always** be removed from the boat to protect it from fog and damp salt air.

In addition to this, it is very necessary to frequently go over the entire motor and especially the under water parts, with an oily cloth. If this is faithfully done, it will prevent the accumulation of the salt deposit, which if left to collect, will make it difficult to operate, cutting down the speed and efficiency to a great extent. The rudder and rudder yoke bearings should be oiled regularly at the three points on the motor indicated by a small arrow and stamped with the word "oil".

If motor is in daily or continual use in salt water, the application of several coats of good spar or marine varnish over its entire surface will do a great deal to protect its appearance and running condition.

The gear case must be kept packed with grease at all times in order to properly protect the gears, shafts and bearings from rust.

We again want to earnestly impress upon salt water users of the ELTO the necessity of properly taking care of their motors as outlined above, in order to get maximum efficiency and service from them. Marine engines of permanent installation are usually well taken care of, covered and protected when not in use and very seldom subjected to the abuse and lack of care to which the "outboard" must submit. The ELTO comes to you so beautifully finished and ready to give you the utmost in fine performance that we sincerely hope you will give it the intelligent care which any piece of good mechanism is entitled to under the trying and severe conditions of salt water use. In exchange for this you can expect from it years and years of most satisfying service.

REMOVING MOTOR FROM BOAT

It is important to remember, when removing motor from boat, not to raise it out of the water rapidly and drop it immediately to a side position. If this is done, the water in the main lower casing will immediately run back into the exhaust manifold and will enter the cylinder which is down, through the open exhaust port. This would result in the cylinder and piston, as well as the piston rings, becoming rusted, should the motor be put away with the water in it.

To avoid this trouble, when removing the motor, raise it straight up out of the water and hold it for a few seconds. This will then permit the water in the main casing to run out through the underwater exhaust port and through the center of the propeller wheel.

CYLINDER JACKETS ARE SELF-DRAINING

It is not necessary to drain the water from the cylinder jackets as the propello-pump has no valves. Consequently, the water runs back through the inlet pipes as soon as the motor is stopped. This thoroughly drains both the cylinder jackets as well as all the pipes thereby avoiding damage to these parts whenever the motor is used in freezing temperature.

PROPER POSITION OF MOTOR WHEN NOT IN USE

Never leave motor in an up-side-down position when not in use. If left in this position, water from the gear housing is apt to run down the drive shaft and enter the crank case and cylinders, causing the pistons and rings to rust, and this will then necessitate taking down the motor, for the piston rings will be rusted in the grooves in such a manner as to cause a loss of compression. It is very important to remember this. It will help avoid considerable trouble and expense.

It will be noticed that the ELTO shipping case is provided with an angular-shaped block to prevent the motor from being stood on end while in transit. It is also important to remember this where the ELTO carrying case is used. Because of the shape of this case, it is very apt to be set on end, thereby standing the motor upside down. It is perfectly safe to tilt the motor or leave it in a horizontal position.

KEEP FLYWHEEL HANDLE IN A FORWARD POSITION

Keeping the handle in this position or in line with one of the cylinders, as shown in Fig. 9, on Page 9, when motor is not in use, brings the pistons up near the top of the stroke, thereby closing the ports in the cylinders. This will prevent water from entering the cylinders through the open exhaust ports. Closing the ports in this way, especially when the motor is not to be used for some time, permits the pistons and rings to retain the lubricating oil which the air entering the cylinders would otherwise dry up.

PUTTING MOTOR AWAY FOR THE SEASON

When putting the motor away for a great length of time, it is of importance to give it some attention, so that it will be in good running shape when you again wish to use it.

It is well to remove both of the spark plugs and inject plenty of lubricating oil into the cylinders. The flywheel is then to be revolved a number of times in order to work this oil thoroughly into the pistons and rings. This will preserve these parts and eliminate the danger of them becoming rusted.

It is best to keep the motor in a dry place in order to protect as much as possible, the coil and timer. Should the motor be subjected to dampness, it will then be well to apply a liberal coat of soft grease or vaseline over the entire surface of the motor. This can easily be removed with a cloth saturated with gasoline when the motor is again to be used.

Also see that the flywheel handle is in a position to the front of the motor or in line with one of the cylinders. This will close the cylinder ports and will keep the oil from drying up.

It does not matter whether motor is stood up in a vertical position or whether it is set in a horizontal position. It should not, however, be left standing in an inverted or an "up-side-down" position, as the water in the gear casing is apt to follow the shaft and enter the crank case.

WHAT TO DO WITH MOTOR IF IT HAS BEEN SUBMERGED IN WATER

If motor, through an accident of any kind, has been completely submerged in water, it will be well to remove the timer cover and drain out the water in the timer, to eliminate any danger of the timer mechanism becoming rusted. It will also be well to oil the parts of the timer with a very light oil. No doubt there will be water in the cylinders and crank case, which will have to be removed to prevent the rings from becoming rusted. To remove this water, it will be necessary to take out the spark plugs and revolve the flywheel rapidly by hand for some time. Thereafter, add a small portion of lubricating oil to the cylinders, after which it will be well to run the motor for some time in order to allow it to heat up and discharge whatever water may be in the crank case.

The coil is heavily insulated with a water-proof cover. However, if the motor has been completely submerged for any length of time the coil should be removed and dried out in a warm place. (See Page 34, How to Remove Coil). Do not place it next to steam pipes or in a place where it is very hot.) Be sure also to drain the gasoline tank thoroughly, to avoid the trouble which would follow in running the motor again, with water in the gasoline.

TO PROTECT BATTERY FROM SHORT CIRCUIT

When battery is not in use, see that the black insulated terminal nuts, furnished with the battery, cover the binding posts at all times, for this will protect the batteries from a short circuit, which would occur should the exposed binding posts come in contact with any metal parts.

PROPER LUBRICATION OF MOTOR

Much of the trouble experienced in the hard starting of outboard motors, and their missing fire, is the result of too much or too heavy a lubricating oil in the gasoline, which in turn causes the plugs to foul. It is very important to strictly abide by the amount of oil specified in the Operating Directions, viz.: one-fourth pint to a gallon of gasoline, using MEDIUM grade oil wherever possible. Use HIGH-TEST gasoline, particularly in cold weather, and at all times if possible. We advise against using gasoline already mixed with lubricating oil, put up and sold for outboard motors by many Lake Resorts, Filling Stations and Garages, unless the user is sure that such mixture is properly proportioned. Careless mixing of the oil and gasoline results in much trouble in starting the motor. Always mix the gasoline and lubricating oil in a separate can and when pouring it into the motor tank, use a strainer or chamois skin for clearing. NEVER UNDER ANY CONSIDERATION run the motor without lubricating oil in the gasoline. This will ruin the motor in a few minutes' running. Our guarantee does not cover injury to the motor caused by running without oil.

LUBRICATION OF GEARS.

The ELTO Motor is entirely and efficiently lubricated through the mixing of the oil with the gasoline, with the exception of the gear case, which needs special attention, for while it is packed with cup or soft grease when motor leaves the factory, it should be refilled at least once or twice a month where motor is used quite steadily. It is most important not to neglect the lubrication of gears, for proper attention to this important item adds greatly to the life of these parts. We recommend grease especially adapted for underwater use, and which we can supply. (Refer to Accessories on Inside Back Cover.)

The grease is supplied to the gear housing by removing the small brass plug stamped in the casting with the word "Grease." The use of a grease gun is necessary to insert grease through this opening. The housing can also be filled with grease by removing the two round head screws on each side of the gear case. This permits the propeller wheel and shaft as well as the gear case cover and one of the gears to be removed, thus opening the entire front of the gear case and allowing it to be easily filled. (See Fig. 15, Page 36). When removing the shaft in this manner, be careful not to lose the lignum vitae plug which acts as a propeller shaft thrust bearing, as it fits loosely inside the bronze adjusting bearing.

Be Sure and Properly Assemble the gear case, cover No. 903 with the port opening for the exhaust on top. If assembled with this port opening in the opposite position, the underwater exhaust is cut off completely. (See Fig. 15.)

TIMER NEEDS NO SPECIAL LUBRICATION

The lubrication of the ELTO Timer mechanism, including the eccentric strap and rocker shaft, is adequately taken care of through the mixture of oil with the gasoline. The oil is forced up through the main bearing, lubricates the timer eccentric and is then carried through a drill hole in the brass eccentric strap, in turn lubricating the rocker shaft and timer mechanism. The appearance of oil on the rocker shaft pin at any time is a clear indication that the motor and bearings are receiving the proper lubrication.

ADD NO ATTACHMENTS TO THE ELTO LIGHT TWIN

We ask the user not to add any fixtures or attachments to his ELTO Motor, such as flywheel starter, special coil or carburetor or any other part which was not originally furnished with the motor. He will appreciate, we are sure, that this would prevent him from enjoying our guarantee, for the addition of any part not furnished by us is bound to defeat in some measure the successful performance of the ELTO Motor. Write our Service Department fully if your ELTO Motor gives you any trouble you cannot locate or remedy. They will promptly take care of your needs in this direction and will see that your motor is made to perform with its usual splendid efficiency.

HOW TO INSTALL NEW THUMB SCREW BUTTONS

Slip the button into place over the ball end of the thumb screw in the bracket. Place a block of wood or a board in the bracket and draw up on the thumb screw. This will hold the button rigid and the four prongs can then be bent in around the ball, with the aid of a punch and hammer.

PACKING MOTOR FOR RE-SHIPMENT

When motor is to be re-shipped, pack it according to Fig. 14 below, which shows the motor supported or held in place securely between the wedges pressing on the flywheel nut and forcing the bottom of the bracket against the center braces. Use plenty of paper (corrugated preferred) AND ALWAYS pack the motor with the rudder up and in a folded position. See that the ports in the cylinders are closed by having the flywheel handle to the front of the motor.

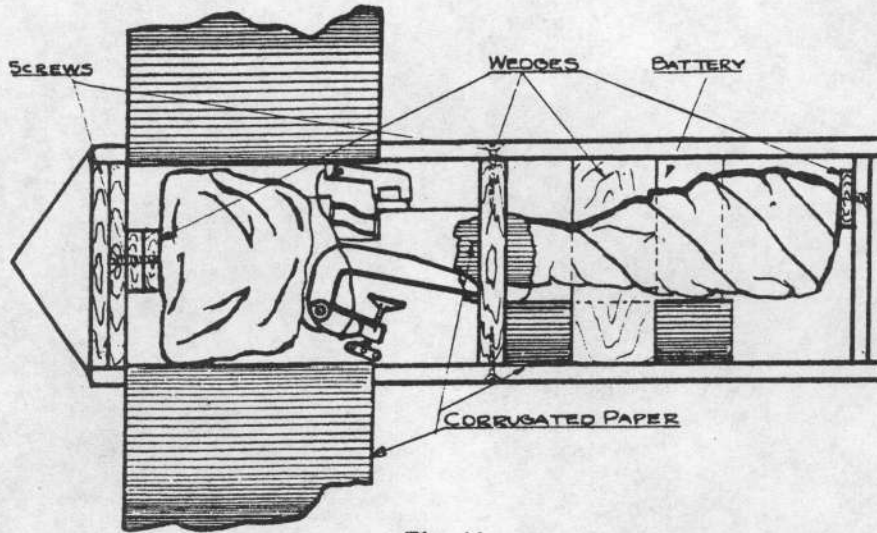

Fig. 14

Be Sure to Keep the Elto Packing Case and Fittings Intact for re-shipping at any time. This case is especially designed for the ELTO and so constructed as to protect it when subjected to rough handling in transit. Many ELTO users convert this case into sort of a trunk by adding hinges and hasp for the top, handles on the ends, using screws in the supporting pieces inside and applying a coat of paint. This makes a very fine shipping case.

Instructions on Taking Motor Apart

UPPER ASSEMBLY

How to Remove Flywheel

The flywheel is drawn onto a taper on the crank shaft by the flywheel nut. To take off the flywheel, first remove the nut and place a block of hard wood or brass on the end of the shaft. With a hammer hit the block a fairly good blow, lifting up on the flywheel at the same time. In taking off the wheel be careful not to lose the key, which is apt to drop out during this operation.

How to Remove Timer

After removing flywheel as described above, it is then necessary to remove the timer cover. This is done by removing the two brass screws. The two terminal screws holding the coil wire connections are then removed and the wires can then be pulled down through the hole in the bottom of the timer case. After loosening the set screw which controls the friction, the timer can then be raised up and removed.

How to Remove Gasoline Tank

After removing flywheel and timer, as described above, the gasoline tank can be removed by first disconnecting the gasoline feed pipe to the carburetor. Then remove the two screws which also hold the brass coil supports and also one screw in the rear support.

How to Remove Coil

Remove flywheel, timer and gas tank, as described above, and the coil can then be removed.

How to Remove Carburetor

First loosen the gasoline feed pipe connection at the carburetor only. Then after removing the two screws holding the carburetor, it can be removed from the crank case.

It is not necessary to disturb the carburetor whatsoever, if the gasoline feed pipe only is desired to be removed. This can be done by disconnecting both the union nuts at the carburetor and gasoline tank.

When again putting on the carburetor it is very important to see that a new gasket is placed between it and crank case as in most cases the old gasket is usually torn somewhat in removing.

How to Remove Cylinders

Disconnect both the intake and outlet water pipes; also remove the exhaust manifold. Then remove the four cap screws holding

cylinder to crank case. The cylinder can then be pulled straight out from the crank case.

How to Remove Pistons and Wrist Pins

Remove the cylinder as described above. Then insert a screw driver down through the hollow wrist pin and straighten the ends of the cotter pin holding the wrist pin. The cotter pin can then be removed from the inside of the piston with the aid of pliers. The wrist pin can then be driven out of the piston and piston is removed from connecting rod.

How to Remove Connecting Rods

After removing cylinders and pistons as described above, the connecting rods can then be removed from crank shaft by removing the two screws which hold the cap of the connecting rod. It will require the use of a heavy screw driver or a brace and bit to remove these screws, as they are drawn up very tightly. When again putting on the rods, be sure and "Spot Punch" the rod at the screw heads, to keep the screws from coming out.

How to Remove Crank Case and Crank Shaft

Remove the flywheel, timer, gas tank, coil, carburetor, cylinders, pistons and connecting rods, as described above. Then remove the bracket and disconnect the cut-out rod by pulling it out of the cut-out cover. Remove the four cap screws holding the main lower casing to crank case and the crank case can then be lifted straight up and removed. Also the crank shaft can then be lifted from the lower main bearing in the lower casing. It is not pinned to the drive shaft but is bored out on the lower end and slips over the drive shaft. The end of the crank shaft is slotted and engages two drive pins, passing through the shaft. (See Fig. 15, Page 36).

HOW TO REMOVE THE PROPELLO-PUMP

First uncouple the four water pipe connections at the cylinders, both inlet and outlet pipes. Then remove the upper and lower rudder pins Nos. 801 and 802. Next remove the four fillister head screws which hold the tiller yoke bracket to the housing. The entire assembly consisting of rudder, rudder yoke and the fulcrum pipe can then be removed from the motor.

The fulcrum pipe or intake tube extends down in to the rudder approximately 1 inch below the milled slot. This tube is not fastened in the rudder and the tiller yoke and rudder can be separated by pulling them apart. The tube seats on a bronze bushing which is pressed into the top of the rudder. It fits tightly against the bushing, making a water tight connection, at the same time, permitting the rudder and tiller yoke to swing.

The larger spring is intended to act as a "hold down" spring for the yoke, keeping it securely in place in the milled slot. The smaller spring which is above the pipe clamp acts as a "hold down" for the pipe and keeps the pipe pressed firmly against the bronze seat in the rudder.

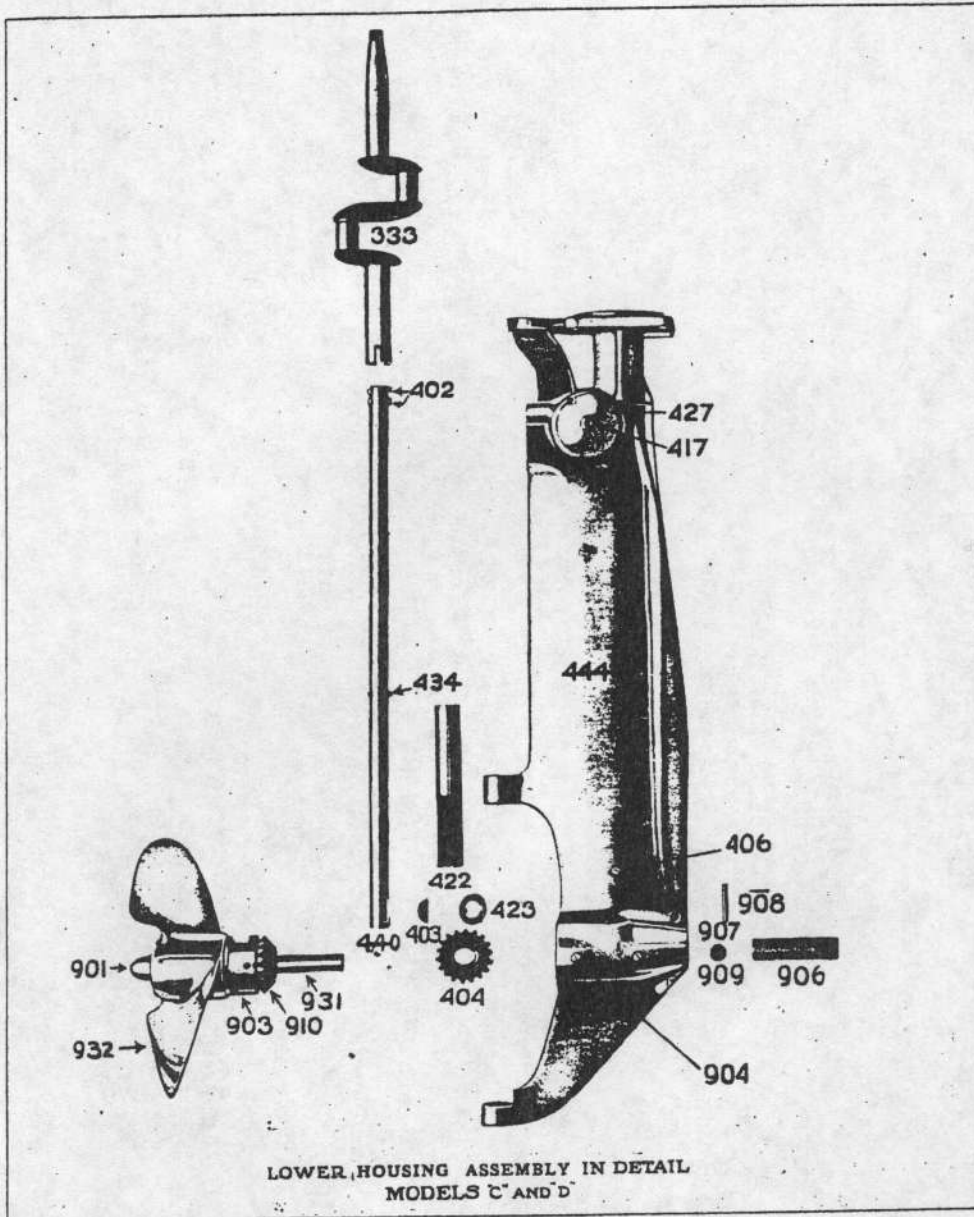

Fig. 15

LOWER ASSEMBLY

(Illustrated on Page 36)

How to Remove Drive Gear No. 404 and Thrust Washer No. 423

To remove these parts, it will first be necessary to remove the entire main lower casing, No. 444, from the engine proper. First remove the cut-out rod by pulling it out of cut-out cover, No. 427. It is then necessary to remove the water intake pipes from both cylinders. Then, after removing the four screws connecting the main casing, No. 444, to the crank case, also remove the two screws connecting main casing to the exhaust manifold. By placing a block of wood against the main casing and striking lightly on it with a hammer, it can then be removed from the engine proper. The crank shaft, No. 333, is bored out at the bottom and slides over the drive shaft, No. 440. Therefore the shafts will come apart at this point.

Remove the entire lower assembly, consisting of propeller wheel, nut, bearing, shaft and gear (as shown on Page 36). The drive gear and thrust washer can then be removed by lifting up on drive shaft No. 440, as far as it will go. The gear, which is driven on a sliding "Woodruff" key, No. 403, can then be dropped down into the gear case and removed.

To remove the thrust washer, No. 423, after having removed the gear, it is necessary to turn the shaft until the "Woodruff" key engages the slot in the thrust washer. This permits it to slide over the key.

When again assembling, it is important to see that the small tongue, on the washer No. 423, is pointing upward. This tongue engages a slot in the lower end of the threaded vertical bearing, No. 422, and keeps it from turning with the gear. This washer is hardened steel and should wear for many seasons.

How to Remove Drive Shaft No. 440 Only

After following the instructions in the above paragraph, on "How to Remove Gear and Thrust Washer," the drive shaft can be removed by first lowering it into the gear case. It will then be necessary to drive out the "Woodruff" key, No. 403, which is swedged into the shaft keyway. This will then permit the shaft to be slid out through the bearing No. 422 by turning the casing upside-down.

How to Remove the Vertical Threaded Drive Shaft Bearing No. 422

After removing the main casing from the motor proper and after removing the gear and thrust washer, as described in the previous paragraphs, a long screw driver is then inserted down through the bronze crank shaft bearing. A slot in the end of drive shaft No. 440 can then be engaged. The drive shaft is then turned until the locking pin No. 434 in the shaft engages the slot in the upper end of drive shaft bearing No. 422.

Remove the two bearing retaining screws No. 406 on either side of the casing. The shaft is then unscrewed to the left and can be removed together with the threaded bearing.

How to Adjust Propeller Shaft No. 931 and Thrust Bearing No. 906

To determine if the propeller shaft, No. 931, needs adjusting, after the motor has been used for a long time, take hold of the propeller wheel and push in and out on it. If considerable play is apparent between the back of the wheel and the casing, this should be taken up. To do this, take out the cotter pin, No. 908, located in the open hole through the casing above the thrust bearing. This will then permit the lock pin, No. 907, to be removed. The thrust bearing, No. 906 can then be turned, with a large screw driver, one-quarter turn or one notch to the right. If this is not sufficient, turn it another notch, or until the play has been entirely taken up. Do not draw up so tightly that it will bind the shaft.

The propeller shaft thrusts against a lignum vitae plug, No. 909, inside of the thrust bearing, No. 906. There is practically no wear on this plug, as the thrust is partly on the gears.

Therefore, inasmuch as the vertical or drive shaft gear thrusts against the hardened steel washer No. 423, it is practically impossible for it to wear itself out of mesh with the propeller gear.

Complete List of Parts and Accessories With Prices

Also Instructions On How To Order

For their convenience, as well as ours, we ask our customers to carefully follow our instructions in ordering ELTO repair parts.

Always give the serial number of the motor for which the part or parts are required. This is very important, and is necessary to intelligently fill your order. If you cannot give us the number of the motor, state when and from whom motor was purchased.

Order by Part Number, giving Name of part also.

Code Words. Use code words when ordering by telegram, but not when ordering by letter or telephone.

Shipping Instructions. State whether shipment is to come forward by express, freight or parcel post.

Remittance. Always accompany your order by cash sufficient to cover the cost of the articles and transportation charges. This will save both time and money, and will eliminate the annoyance of a C. O. D. shipment. Postage will be accepted in payment of orders not exceeding \$1.00.

Instructions for Returning Parts. Tag each part with motor number from which it is removed. Place name and address plainly on each tag, and at the same time advise us by letter what parts are being returned and your object in returning them.

Transportation charges must be prepaid on all parts returned to the factory.

Prices quoted in this Booklet are subject to change without notice.

**ELTO OUTBOARD MOTOR COMPANY
MILWAUKEE, U. S. A.**

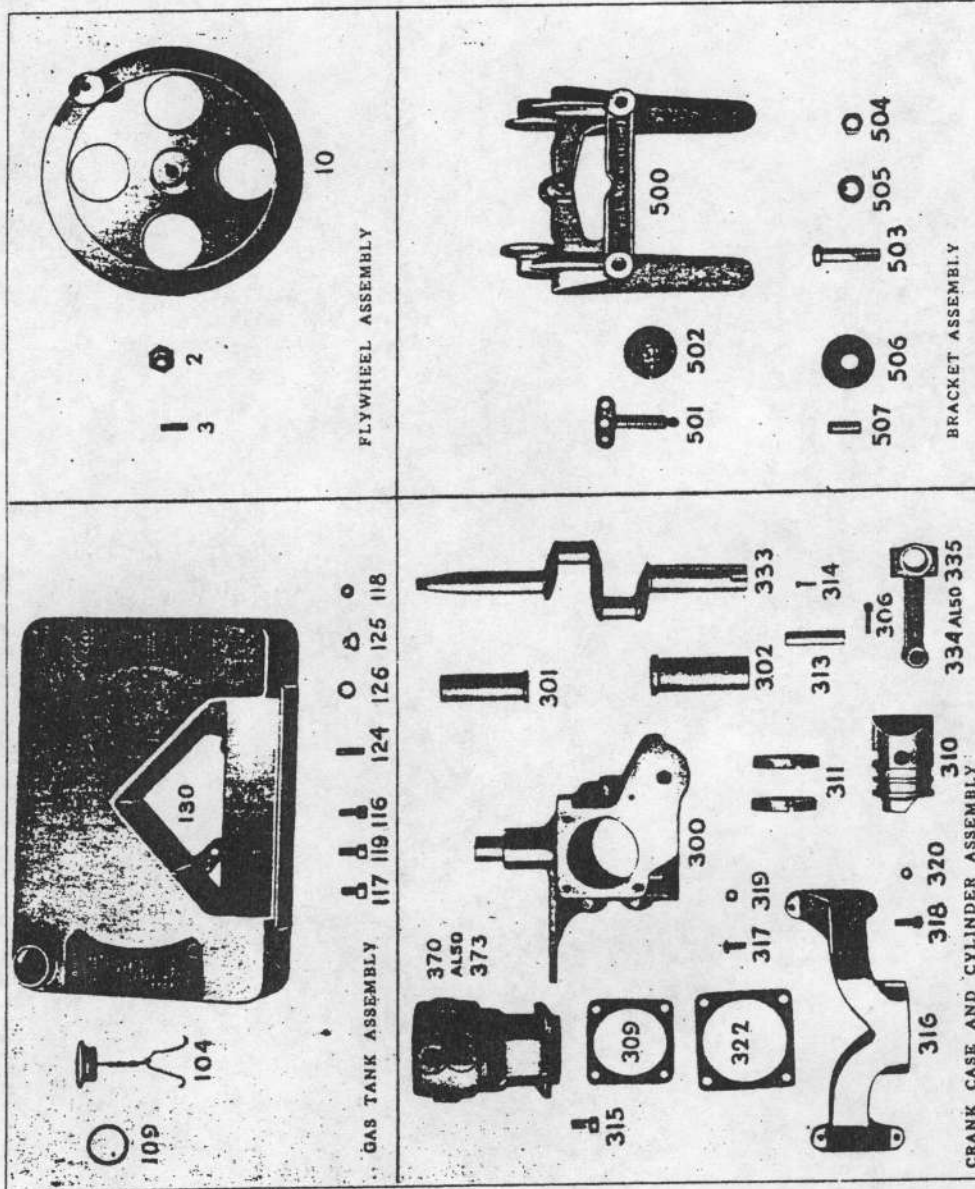

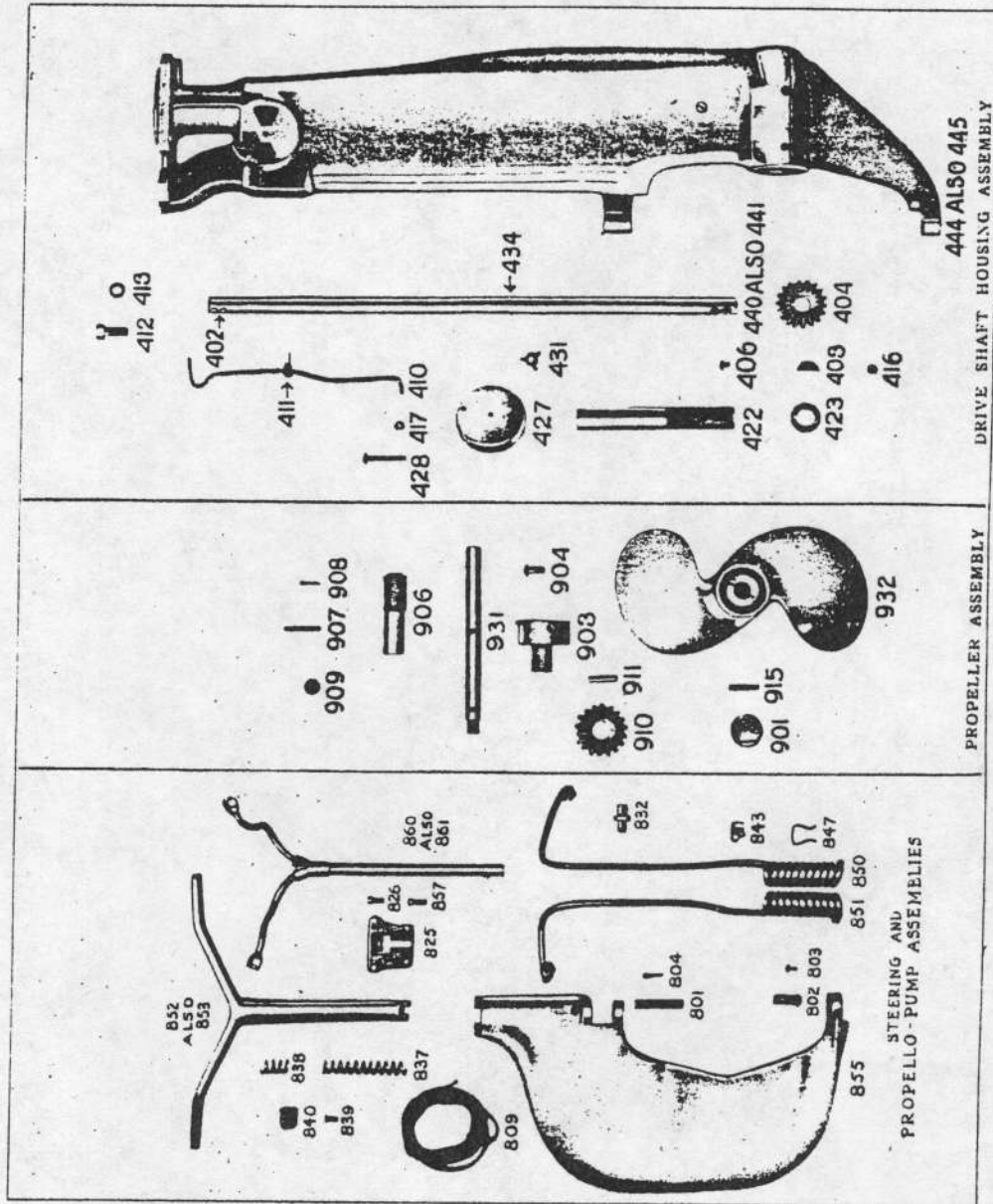

Drive Shaft Housing, Propeller, Steering and Propello-Pump Assemblies

Part No. Code	Name of Part	Price No. of Pieces Used on Each Motor	Part No. Code	Name of Part	No. of Pieces Used on Each Motor	Price Per Part
DRIVE SHAFT HOUSING ASSEMBLY						
402	Acrid	2	840	Dyke	1	.40
403	Aculeate	1	843	Dync	2	.10
404	Acute	1	847	Fager	1	.10
406	Adagio	2	850	Baglet	1	1.50
410	Adduce	1	851	Eagre	1	1.50
411	Adduct	1	852	hath	1	3.00
412	Adieu	4	853	Eaves	1	3.25
413	Adios	4	855	Ebon	1	8.00
416	Admon	1	857	Echo	2	.05
417	Ado	2	860	Eclat	1	2.00
422	Arcola	1	861	Ecruc	1	2.00
423	Arcs	1	875	Edda	1	1.50
427	Arles	1	876	Eddy	1	1.50
428	Arras	1	PROPELLER ASSEMBLY			
431	Druce	1	901	Balk	1	.40
434	Dryad	1	903	Ball	1	1.00
440	Duad	1	904	Ballast	2	.10
441	Dual	1	906	Ban	1	.60
444	Ducal	1	907	Bang	1	.10
445	Duchy	1	908	Bank	1	.10
801	Back	1	909	Banner	1	.05
802	Bacon	1	910	Bar	1	.10
803	Badge	1	911	Barber	1	1.50
804	Badger	1	915	Beta	1	.10
809	Baker	1	931	Eden	1	.05
825	Dusk	1	932	Edict	1	1.60
826	Dwarf	2				4.00
832	Dwell	4				
837	Dwelt	1				
838	Dwine	1				
839	Dyad	1				
STEERING ASSEMBLY						
	Rudder Pin (upper).....	1		Propeller Nut.....	1	
	Rudder Pin (lower).....	1		Propeller Cover Bearing..	1	
	Rudder Pin Screw.....	1		Propeller Cover Bearing	2	
	Rudder Cotter Pin.....	1		Screws.....	1	
	Tiller Rope.....	1		Propeller Thrust Bearing..	1	
	Tiller Yoke Bracket.....	1		Propeller Thrust Bearing	1	
	Bracket Screw (upper)...	2		Cotter for Thrust Bearing	1	
	Pipe Half Union.....	4		Pin.....	1	
	Yoke Hold-down Spring...	1		Pin for Thrust Bearing...	1	
	Tube Hold-down Spring...	1		Propeller Gear.....	1	
	Tube Clamp Screws.....	1		Propeller Gear Pin.....	1	
				Propeller Shear Pin.....	1	
				Propeller Shaft.....	1	
				Propeller Wheel.....	1	

Always give the serial number of the motor for which the part or parts are required. This is very important, and is necessary to intelligently fill your order. If you cannot give us the number of the motor, state when and from whom motor was purchased.

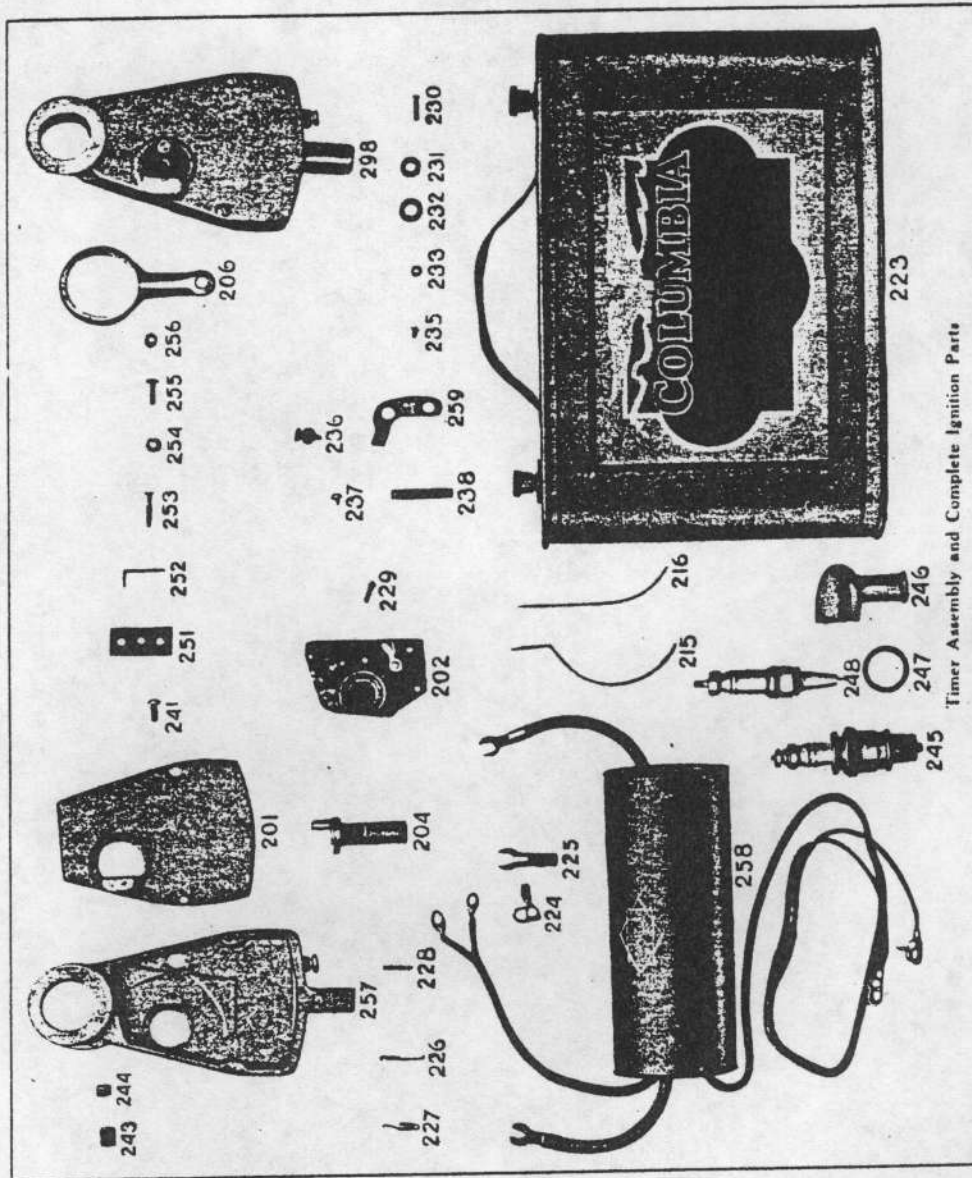

Timer Assembly and Complete Ignition Parts

Timer Assembly and Complete Ignition Parts

Part No. Code	Name of Part	No. of Pieces Used on Each Motor	Price Per Part	Part No. Code	Name of Part	No. of Pieces Used on Each Motor	Price Per Part
TIMER ASSEMBLY							
201	Abrade	1	.45	241	Aims	2	.05
202	Abut	1	8.00	243	Friction Screw	1	.05
204	Abyss	1	1.00	244	Friction Plug	1	.10
206	Accent	1	.50	245	Spark Plug	2	.75
215	Accous	1	.15	246	Hood	2	.20
216	Acetic	1	.15	247	Althea	2	.05
223	Acne	1	2.10	248	Alton	2	.35
224	Acorn	2	.10	251	Ascent	1	.60
225	Align	2	.10	252	Asgard	1	.15
226	Angola	1	.25	253	Ashen	2	.05
227	Angora	1	.20	254	Ashy	2	.05
228	Anight	1	.10	255	Asp	1	.05
229	Anil	1	.05	256	Aspic	1	.05
230	Animus	2	.05	257	Aster	1	3.00
231	Anion	2	.05		Timer Case with Push Button	1	7.00
232	Anise	4	.05	258	Atabal	1	3.5
233	Anklet	2	.05	259	Atlas	1	
235	Alkali	1	.05	260	Droll	2	.05
		1	.80	262	Drone	2	.05
		1	.05	298	Atoll	1	15.00
		1	.85		Timer complete	1	

Always give the serial number of the motor for which the part or parts are required. This is very important, and is necessary to intelligently fill your order. If you cannot give us the number of the motor, state when and from whom motor was purchased.

Carburetor Assembly

Part No. Code	Name of Part	No. of Pieces Used on Each Motor	Price Per Part
CARBURETOR ASSEMBLY			
703	Needle Valve	1	.20
704	Needle Valve Packing Gasket	3	.05
705	Packing Nut	1	.10
707	Lock Nut	1	.10
709	Clamp Screw	1	.05
710	Throttle Stem	1	.15
712	Friction Spring	1	.10
713	Stem Packing Gasket	3	.05
715	Air Inlet Valve Spring	1	.10
717	Gland Screw	1	.05
718	Flange Gasket	1	.05
722	Screw	2	.10
725	Corrugated Washer	1	.20
726	Retaining Pin	1	.05
730	Body only	1	2.00
731	Body Cap	1	.70
732	Air Inlet Valve	1	.30
733	Needle Valve Friction	1	.15
736	Friction Guide	1	.25
737	Friction Spring	1	.05
738	Cap Gasket	1	.05
741	Half Union	2	.15
742	Gasoline Feed Pipe Complete	1	.60
744	Throttle Clamp	1	.25
751	Carburetor complete	1	4.75

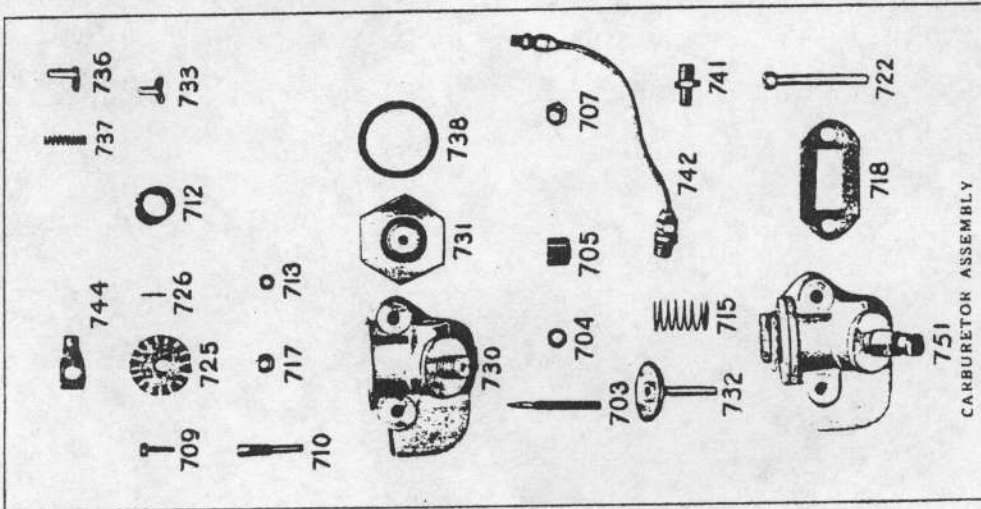

Always give the serial number of the motor for which the part or parts are required. This is very important, and is necessary to intelligently fill your order. If you cannot give us the number of the motor, state when and from whom motor was purchased.

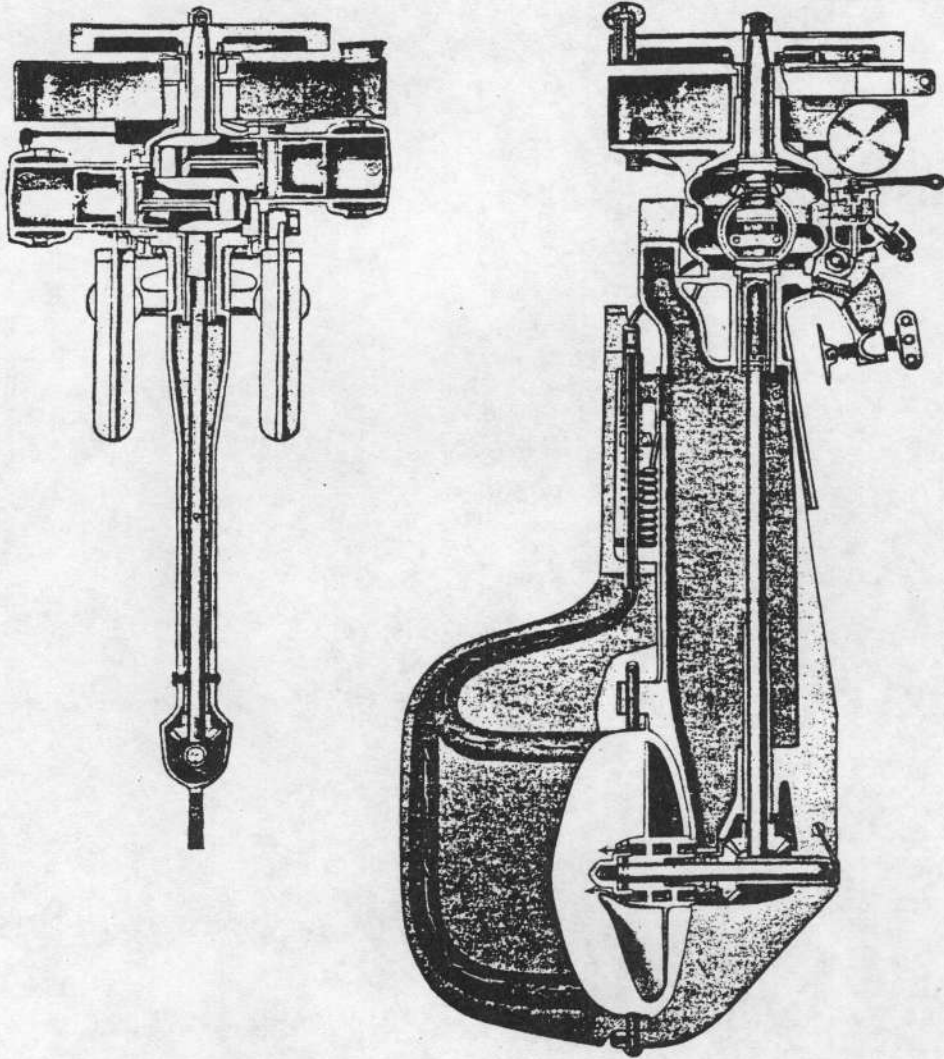

Sectional Views of Elto Light Twin

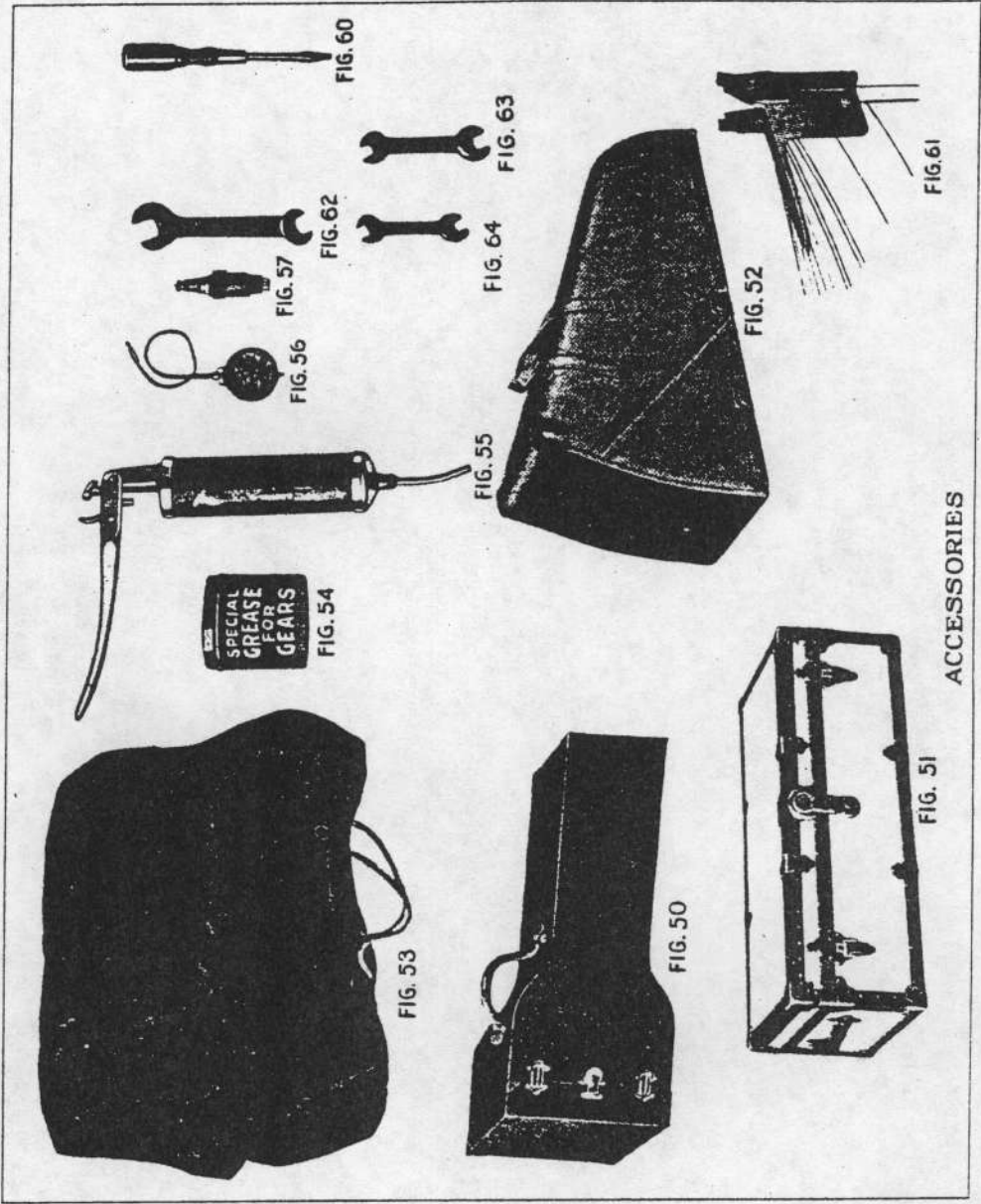

ACCESSORIES

ACCESSORIES

*Fig. 50.	ELTO Carrying Case	10" x 14" x 37"	16 lbs.	\$20.00	Dece
*Fig. 51.	ELTO Trunk	11 1/2" x 15 1/2" x 38"	35 lbs.	20.00	Celt
*Fig. 52.	ELTO Canvas Carrying Bag (collaps)	9 1/2" x 17"	5 lbs.	5.50	Cese
Fig. 53.	ELTO Canvas Hobd. of Cover			1.00	Chalc
Fig. 54.	ELTO Shipping Case (not shown)	12" x 16" x 43"	38 lbs.	2.50	Chary
	One Pound Can "ELTO" Special Gear Grease			.50	Chasse
	Three Pound Can "ELTO" Special Gear Grease			1.00	Chalk
Fig. 55.	ELTO Grease Gun			2.50	Chasmi
Fig. 56.	Ammeter (for testing Battery)			1.50	Chela
Fig. 57.	FYRAC Spark Plug			1.00	Chert
Fig. 60.	Screw Driver			.25	Chsp
Fig. 61.	Bracket (aluminum casting) for pointed stern boat			5.00	Chapel
Fig. 62.	Large wrench for Flywheel, bracket and spark plug			.75	Eddie
Fig. 63.	Medium wrench for Propeller nut and pipe conn.			.55	Eddt
Fig. 64.	Small wrench for carburetor and gasolins line			.40	Educa
	Rajah Waterproof Spark Plug, complete with rubber hood (not shown)			1.25	Efflux
Part No. 922	Bronze Propeller Wheel (not shown)			4.50	Effuse
	(Same as regular Elto Wheel Part No. 932)				
Part No. 921	Bronze Nut for above wheel (not shown)			.60	Egis
	(Same as regular part No. 901)				
Part No. 926	Right Hand Propeller Wheel (not shown)			4.50	Egret
	(Aluminum)				
	Trolling Attachment (Shown on page 15)			4.00	Elan

*Specify whether desired for Model "C" or Model "D"