

**EVINRUDE SERVICE**

**MANUAL**



**PRICE \$3.00**



**EVINRUDE MOTORS**

**MILWAUKEE, WISCONSIN, U. S. A.**

*In Canada, Evinrude Motors of Canada, Peterboro, Canada*

With a large share of our production facilities devoted to the national emergency, our production of new motors is bound to fall short of the demand. In such a situation motors in your customers' hands will have to last longer. So, servicing looms of greater importance. To help you provide better, prompter service in this situation, and beyond it, we have prepared this service manual. We will send you additional pages for it from time to time, and we invite your suggestions. We dedicate it to Evinrude service men—everywhere.

EVINRUDE MOTORS



TABLE OF CONTENTS

SECTION	SUBJECT	PAGE
	Index to Illustrations, Charts, Etc.....	4-5
I	Service Department Layout and Suggestions.....	7
II	Motor Warranty and Service Policy.....	9
III	How to Order, Forms .....	10
IV	Principle of Operation, Powerhead Assemblies .....	11
V	Installations of Motors on Boats .....	12
VI	Lubrication and Fuel .....	14
VII	Tuning Up Motors .....	15
VIII	Starting and Operating Instructions .....	16
IX	Suggested Procedure for Dismantling Motors .....	22
X	Simple Overhaul Procedure .....	24
XI	Magnetos, Armatures, Flywheels .....	24
XII	Fuel Tanks .....	33
XIII	Cylinders .....	35
XIV	Piston and Rings .....	36
XV	Connecting Rods .....	38
XVI	Crankshaft, Crankcase .....	40
XVII	Propellers .....	43
XVIII	Bearings .....	44
XIX	Mufflers .....	45
XX	Carburetors .....	45
XXI	Simplex Starter .....	49
XXII	Stern Bracket, Pivot Bearing, Co-Pilot .....	51
XXIII	Gear Housings .....	52
XXIV	Running in, Submerged Motors .....	56
XXV	Index .....	97-98



## INDEX TO ILLUSTRATIONS

Fig. No.	Subject	Page
	Service Department Layout .....	7
	Advertising Identification Signs .....	8
	Telephone Directory Advertising .....	8
	Card file of Customers .....	8
	Billboard Sign .....	8
	Newspaper Storage-Service Ad .....	9
1	2-Cycle Engine Principle (up stroke) .....	11
2	2-Cycle Engine Principle (down stroke) .....	11
3	Power Head Assembly, Single Cylinder .....	12
4	Power Head Assembly, Twin Cylinder .....	12
5	Power Head Assembly, Four Cylinder .....	12
6	Installation of Motor on Boat .....	12
7	Elimination of Stern Spray .....	13
8	Attaching Wires to Spark Plugs .....	14
9	Fuel Cans .....	14
10	Keep small Parts in Bread Tins .....	22
11	Evinrude Zephyr .....	23
12	Magneto for Single Cylinder Evinrude .....	24
13	Magneto for Twin Cylinder Evinrude .....	24
14	Magneto for Four Cylinder Evinrude .....	24
15	Adjusting Spark Plug Points .....	25
16	Adjusting Magneto Contact Points (flywheel removed) .....	25
17	Adjusting Magneto Contact Points (through inspection hole in flywheel) .....	26
18	Cleaning Contact Points .....	26
19	Condenser Tester .....	26
20	Condenser Tester (Home-Made) .....	27
21	Eisemann Coil Tester .....	27
22	Coil Tester (Home-Made) .....	28
23	Adjusting Speed Control Lever Friction .....	30
24	Spark Plug Eyelet Forming Tool .....	30
25	Keeper across Magneto Poles .....	31
26	Removing Flywheel with hammer blow .....	31
27	Tightening Flywheel with Spanner Hook Wrench .....	31
28	Removing Flywheel with Puller .....	31
29	Adjustment of Out-of-true Flywheels (marking) .....	32
30	Adjustment of Out-of-true Flywheels (tapping) .....	32
31	Removal of Fuel Line (use wrench) .....	33
32	Fixture for handling Fuel Tank when repairing .....	33
33	Handling Blow Torch Flame and applying Solder .....	33
34	Handling Blow Torch Flame and smoothing Solder .....	34
35	Filing away excess solder around Fuel Tank dent .....	34
36	Cutting Fuel Tank to pound out opposite wall .....	34
37	Self-forming Gaskets .....	35
38	Checking Piston with Micrometer .....	36
39	Removing Carbon from Ring Groove .....	37
40	Checking gap between ends of Ring .....	37
41	Rolling Rings around Piston Groove to check fit .....	37
42	Lapping Piston Rings .....	37
43	Reaming Piston Pin Hole .....	38
44	Refitting Bronze Rods .....	38
45	Reaming Bronze Rods .....	38
46	Checking Rods for Misalignment .....	39
47	Straightening Rods with Lining Up Bars .....	39
48	Correct Position of Piston .....	39
49	Checking Crankshaft Alignment .....	40
50	Straightening Crankshaft .....	40
51	Disassembling of Sportwin (removing cylinders) .....	40
52	Disassembling of Sportwin (removing connecting rod Screws) .....	40
53	Disassembling of Sportwin (removing crankcase) .....	41
54	Disassembling of Sportwin (crankcase removed) .....	41
55	Marking Connecting Rods for Position .....	41
56	Tapping Dowel Pin into Zephyr Crankcase .....	41
57	Removing Dowel Pins with Threaded Tool .....	42



## INDEX TO ILLUSTRATIONS

Fig. No.	Subject	Page
58	Straightening bent Propeller.....	43
59	Pressing out Upper Crankcase Bearings.....	44
60	Automatic Exhaust Relief.....	45
61	Carburetors (Mate and Cub).....	45
62	Lapping Carburetor Check Valve.....	46
63	Removing Sportwin Carburetor.....	46
64	Sportwin Carburetor disassembled.....	46
65	Lightfour Carburetor.....	47
66	Removing Throttle Valve Assembly.....	47
67	Disassembling Sportfour Carburetor.....	48
68	Simplex Starter mounted for Spring Rewinding.....	49
69	Insert Pin to hold rewound Simplex Starter spring.....	49
70	Simplex Starter Spring rewind.....	49
71	Engage Anchor Hook for Simplex Starter Cord rewinding.....	49
72	Pressing Simplex Starter Pulley into position.....	50
73	Changing Cord on Sportfour Simplex Starter.....	50
74	Installing Thumb Screw Buttons.....	51
75	Removal of Gear Housing—Sportwin.....	52
76	Removal of Gear Housing Cap and Screws—Sportwin.....	53
77	Reassembly of Gear Housing and Driveshaft, etc.....	53
78	Installing Driveshaft Bushings in Lightfour Gear Housing.....	54
79	Spiral Bevel Gears.....	54
80	Speedifour Propeller Shaft and Gears.....	55
	Service School Classes.....	57
	Evinrude Ranger Cutaway View.....	86
	Evinrude Sportsman Cutaway View.....	87
	Evinrude Sportwin Cutaway View.....	87
	Evinrude Zephyr Cutaway View.....	88

## INDEX TO CHARTS, ETC.

Form Number		Page
	Evinrude-Elto Coil Winding Specifications, when used with Eisemann Winding Tester.....	28, 29
	Rockwell Crankshaft Hardness Test C Scale.....	43
	Carburetor Valve Lift, Spring Pressure and Float Level.....	46
	List of Blueprints available.....	61, 62
R97	*Chart of Clearances.....	63
	Cylinder Clearance Chart.....	64
	Piston Ring Specifications.....	65
	Crankshaft Sizes.....	67, 68
	Propeller Wheels.....	69, 70, 71
	List of Models and Year Manufactured.....	73 to 82
M998	*Lubrication Chart.....	83
R98	*Shear Pin Chart.....	84
M998	*Spark Plug Chart.....	85
R99	*Trouble Detector Chart.....	89
	Trade-In Allowance Schedule.....	91, 92, 93, 94
	Service Station List.....	95
	Index.....	97-98

indicated. \*Available on Heavier Paper Stock suitable for Wall Mounting in your Service Shop, etc. Request by Form Number



SECTION I

**SUGGESTED LAYOUT FOR A SERVICE DEPARTMENT**

Naturally, your service department layout will be governed by such factors as business volume, space availability, and extent of investment. Any service department plan can therefore serve only as a guide, and as a beginning for a plan that most nearly suits your own requirements. Don't hurry your installations too much; plan every step in your layout carefully before proceeding with expensive, permanent improvements. Below is a typical service shop plan for a medium sized repair business.

**HOW TO GET THE MOST OUT OF YOUR SERVICE DEPARTMENT INVESTMENT**

With your money invested in a sound service business, you should use every profitable means at your disposal to obtain the maximum volume of work you can handle, consistent with first class workman-

ship. However, be careful not to take on more than you can handle efficiently, and do not make promises of delivery that you cannot keep. Nothing can lose a good customer more quickly than sloppy repair work that needs to be done over, or unkept promises that waste the customer's (and your) time.

**ADVERTISING—IDENTIFICATION**

If you are set up to efficiently handle a sizeable volume of repair work, let as many people as you can know about it. Your repair shop is an important department of your business and it can be made to earn its share of the profit. In fact, when new motors are difficult to obtain, your service department can easily become the temporary mainstay. One immediate and important need is to properly and thoroughly identify your store with prominent "Authorized Service" signs, both inside and out. Leave no doubts with any customer or visitor that you do Evinrude

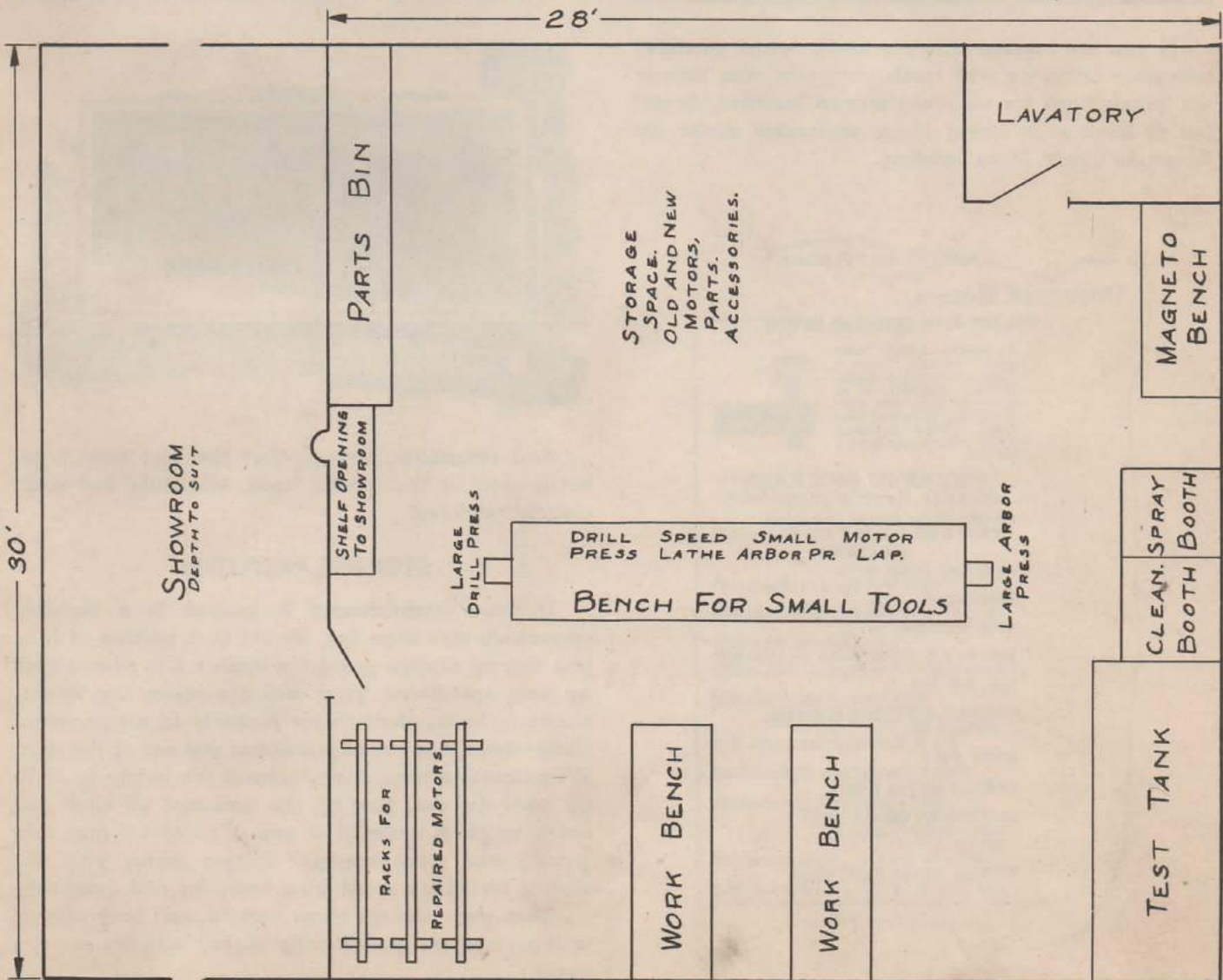



service work. Print a service slogan on your give-away business cards, blotters, etc.



Use a card file for every customer, remind him of your service at opportune times in spring, fall and winter.

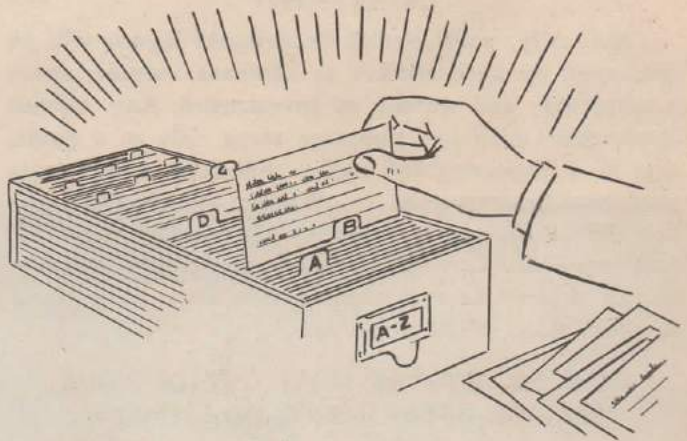

Use a billboard sign or two, and make your service known through mentioning it in every ad you carry, whether it be in newspaper, radio or other medium.

If you are located where a worth while classified telephone directory will reach prospects who look in the 'phone book for outboard service facilities, do not fail to have your listing there, preferably under the Evinrude Trade Mark heading.



And remember, always, that the best service advertisement is the service itself, efficiently and courteously rendered.

**STORAGE FACILITIES**

If your establishment is housed in a building reasonably safe from fire, devote such portion of it as you can to storage space for motors left over winter by your customers. They will appreciate this opportunity to house their motor properly in a convenient place where it is out of the house and out of the way. When boating time comes around, it's handy to drive up with the car, pick up the outboard all slick and ready to go. A roomful or two of motors brings in a good rental from storage charges alone, plus the chance for added profit from trade-ins and overhauls.

Keep your storage room orderly, and keep motors well covered and prominently tagged with the owner's name.

Pages Under "Printers"

**Outboard Motors.**

**EVINRUDE-ELTO OUTBOARD MOTORS**

15 models — light "singles," smooth "twins," four thrilling 4-cylinder models. Exceptional in starting ease, fine performance, advanced features. Easy payment plan. Parts, expert service.



**"WHERE TO BUY THEM"**  
**GENERAL OFFICE & FACTORY**  
 Evinrude Motors Division of Outboard Marine & Mfg Co 4143 N 27th. HI ltop-0643

**DEALERS**

**Aldon Super Service Station**  
 5301 W Lisbon av. KI lbourn-6550

**Chour Joseph I**  
 1773 S Muskego av. OR chard-7508

**Cihak Tire Service Co**  
 1106 N Jefferson. DA ly-1350

**Danielski & Co** 401 W Mitchell. MI tchell-0234

**Fleissner Bros** 1932 W Vliet. WE st-8300

**Hill's Balt Shop**  
 6106 W Natl av. GR eenfield-4500

**KAESTNER BATTERY & ELECTRIC SERVICE INC**  
 414 W Kilbourn av. MA rquette-7070

**POEPP WM F**  
 2043 W Fond du Lac av. KI lbourn-9038

**RUGGLES MARINE MART**  
 1848 E Kenilworth pl. LA keside-0625

**SPORTSMAN'S SUPPLY SHOP**  
 Sales—Service—Rentals—  
 Factory Experts  
 3321A N Pierce. ED gewood-1082

**TESSNER MOTOR BOAT SALES INC** 1404 N 11th. BR oadway-1589



**SECTION II**

**WARRANTY**

Each Evinrude and Elto motor is covered by the following warranty:

**FACTORY WARRANTY**

WE WARRANT each new unit to be free from defects in material and workmanship under normal use and service, our obligation under this warranty being limited to making good at the factory any part or parts thereof which shall, within three months after delivery of such unit to original purchaser, be returned to us with transportation charges prepaid, and which our examination shall disclose to our satisfaction to have been thus defective; this warranty being expressly in lieu of all other warranties and representations expressed or implied and of all other liabilities in connection with the sale or use of any unit.

This warranty shall not apply to any unit which shall have been repaired or altered outside the factory in any way so as to affect its stability or reliability, or in which other than our genuine parts have been installed, or which has been subject to misuse, negligence, accident or racing,\* or operation at more than our recommended r.p.m. as expressed in the horsepower designation. We make no warranty in respect to trade accessories not of our manufacture inasmuch as they are usually warranted separately by their respective manufacturers.

\*The use of the engine for racing voids our warranty. Should you risk the effects of using your motor for racing (resulting in increased revolutions), minimize the injurious effect by mixing a high grade oil, such as Mobiloil Marine Extra Heavy, or Mobiloil "B" with each gallon of gasoline as called for in instructions, see pages 14 and 15.

This warranty we are glad to fulfill at all times. However, please do not ask us for unreasonable adjustments or free service beyond the terms of this warranty as these cannot be granted.

**SERVICE POLICY**

Whether within or following the warranty period, we have a constant interest in our products, and our desire at all times is to have every motor we have produced continue to give top-notch performance. We should like such a desire to pervade our entire distributor and dealer organization and at all times we welcome the prompt request for information and service to restore faulty motors to efficient operation.

For years it has been our policy to assist dealers in building up their service knowledge and facilities so as to place as great a percentage of our dealers as possible within easier reach of prompt, efficient service. Our Service School, frequent Service Bulletins, and

**WINTER STORAGE  
and SERVICE  
for your  
OUTBOARD  
MOTORS**



Every outboard needs a complete service check-up after a season's use. It needs careful storage during the winter months. Make certain NOW that your motor will be sweet-running and dependable when you're again ready to use it next spring. We are experts in servicing every make of outboard. Our prices are moderate. Call on us, or phone us for a quotation on your motor. Complete servicing and storage, as low as \$0.00.

**DEALER SIGNATURE**

*Authorized* **EVINRUDE  
SALES AND SERVICE**

Keep a complete handy file of the following Evinrude current publications up to date at all times for ready reference:

PUBLICATION	REQUEST FORM NO.
Motor Catalog .....	R4
Motor Line Folder .....	R78
Accessories Catalog .....	R50
Reduction Gear Folder .....	M971
Boat and Motor Selector .....	—
Racing Motor Folder .....	R51
Instruction Manuals (All models) .....	—
Parts Catalog (Master) .....	R31 (1941)
Directory of Boat Builders .....	M943
Good Ways to Sell—booklet .....	—



now this Service Manual, represent tangible efforts to render the Evinrude and Elto owner the best and most prompt service possible.

In accordance with our warranty, parts will be repaired or replaced under the following conditions:

1. That permission has been expressly granted by manufacturer for return of parts.
2. That manufacturer's examination discloses actual defect.
3. That customer has paid or will pay transportation charges on replacement or repaired parts.
4. **WE WILL NOT BE RESPONSIBLE FOR TIME SPENT AND WORK PERFORMED BY OTHERS THAN THE FACTORY, UNLESS SUCH REPAIRS ARE FIRST AUTHORIZED BY US IN WRITING.**

Final decision as to defect rests solely with the factory at Milwaukee, Wisconsin, and no repairs or replacement agreement other than the above will be recognized.

**FACTORY SERVICE ORGANIZATION**

At the factory we maintain a complete service organization which consists chiefly of three departments: Management and Correspondence, Motors and Parts Repairs, and Parts and Accessories Stores. All correspondence, orders, returned parts and motors should be addressed to Service Department, Evinrude Motors, Milwaukee, Wis. Always give model, name and serial number of motor.

**IMPORTANCE OF MOTOR REGISTRATION**

Getting the name of every outboard purchaser accurately on the factory records is extremely important. Very often, the service man in the field is in a position to assist in this important job.

If it is part of your job to deliver new motors to customers, make it a point to mail the Dealer's Registration Card (attached to the motor) to us promptly with complete information. If you completely assemble the motor for the customer, install spark plugs, etc., have him fill out the Customer's Registration Card and mail that to us also. **THAT MAKES THE EVINRUDE WARRANTY ON THE MOTOR EFFECTIVE.**

As motors previously unregistered come in to you for repairs, make a careful list of the owners' names and addresses. This will be a valuable list of customers for your establishment in soliciting new business. Whenever convenient, or when we have our Annual Roll Call of Evinrude customers, send us a copy of your list so that our further efforts to get business will supplement yours.

For years we have been building up a list of Evinrude owners which we keep up to date at all times.

It is one of our very most important means of securing new business, and with your complete list of Evinrude owners included, you'll get your full share of resulting business. By cooperating whole-heartedly in this important effort, your service department will naturally be a source of added revenue to your establishment. Cooperate!

**ALWAYS USE GENUINE EVINRUDE PARTS**

For your own protection and that of your customers, always be sure to use genuine parts ordered direct from the factory, or from your Evinrude distributor.

Our warranty on a motor becomes void when other than genuine parts are used in its repair.

Our dealer franchise requires our dealers to use none other than genuine Evinrude parts, and is subject to revocation in cases of violation.

We constantly remind our customers of the dependability of the service on Evinrude products available through our dealers, and we depend upon their loyalty and integrity to support us in turn by refusing to use any non-genuine repair parts.

**SECTION III**

**INSTRUCTIONS ON HOW TO ORDER**

For their convenience, as well as ours, we ask our customers to carefully follow our instructions in ordering parts.

We also request that owners order their parts from our dealer or nearest service station or distributor.

**ORDER BY PART NUMBER** giving **NAME** of part also.

**ALWAYS GIVE THE SERIAL NUMBER OF THE MOTOR FOR WHICH PART OR PARTS ARE REQUIRED.** This is very important, and is necessary to intelligently fill your order. If you cannot give the number of the motor, state when and from whom the motor was purchased.

**TELEGRAMS AND HOW TO USE "EVINRUDE CODE."** Telegram rates are based on ten words or less for immediate delivery. Day letter or night letter rates are considerably cheaper. Detailed information may be found on back of any telegram blank.

Use the following code only on messages of more than ten words. Each five code letters are charged for as a word. English words and code words may be used in the same message, but code letters cannot be combined with English words.

- |     |          |               |
|-----|----------|---------------|
| A—1 | G—7      | Q—Air mail    |
| B—2 | H—8      | V—Air express |
| C—3 | I—9      | X—Express     |
| D—4 | J—0      | Y—Parcel post |
| E—5 | K—Each   | Z—Freight     |
| F—6 | P—Number |               |













**EVINRUDE**  
*Elto*  
**OUTBOARD  
MOTORS**



Following is an example of a telegram not coded and the same reduced to code:

(NOT CODED—22 WORDS.) Parcel Post Two Number One Three Naught Naught Four Four Propeller Nut Twelve One Three Naught Naught Five Three Shear Pins.

(CODED—8 WORDS.) YBPAC JJDD Propeller Nut ABPAC JJEC Shear Pins.

Do not use this code in cable messages.

**ROUTING — TERMS — RETURNS**

**SHIPPING INSTRUCTIONS.** Unless specific instructions accompany the order, we will use our own judgment as how to ship.

**TERMS: CASH WITH ORDER OR C. O. D.**

In ordering parts, to avoid C. O. D. shipments and extra charges, all orders should be accompanied by cash. Save time and money by remitting sufficient cash to cover cost of parts and **TRANSPORTATION CHARGES**. Stamps are accepted in payment of all orders not over \$1.00. The right to hold all orders unaccompanied by cash is reserved by Evinrude Motors, Milwaukee.

A minimum charge of \$0.50 net will be made on all orders amounting to less than this amount. We reserve the right to furnish additional parts to make up the difference.

**INSTRUCTIONS ON RETURNING PARTS.** Parts can only be returned in accordance with terms outlined under the Service Policy laid down in the instruction manual.

For best service, keep on hand for constant use supplies of the forms shown following this page. By using these forms in your typewriter you are assured of more rapid identification and handling. Confine one subject or transaction to a sheet which in turn assures more rapid handling.

**SECTION IV**

**PRINCIPLE OF 2-CYCLE ENGINE**

**OPERATION**

All Evinrude and Elto outboard engines operate on the two-stroke cycle principle, and are of the two-port type. (EXCEPTIONS: Evinrude built about 1000 4-cycle outboards in 1916-17, discarded the model because of excessive weight. Evinrude Lawn-Boy Power Mower, Series 948, 952 and 958 is equipped with a four-cycle engine. Evinrude models prior to 1930 were 3-port type.) The action of the two-port,

two-cycle engine is explained in the illustration below, (Figs. 1 and 2).

The smaller size models employ the check valve carburetor; the larger sizes, viz. Zephyr, Lightfour, Sportfour, Speeditwin, Speedifour and Fleetwin, employ the rotary disc valve in the crankshaft. With each revolution this valve admits a charge of fuel into the crankcase, automatically closing during compression. On the racing Speeditwin the rotary valve is geared to the crankshaft as a separate unit.

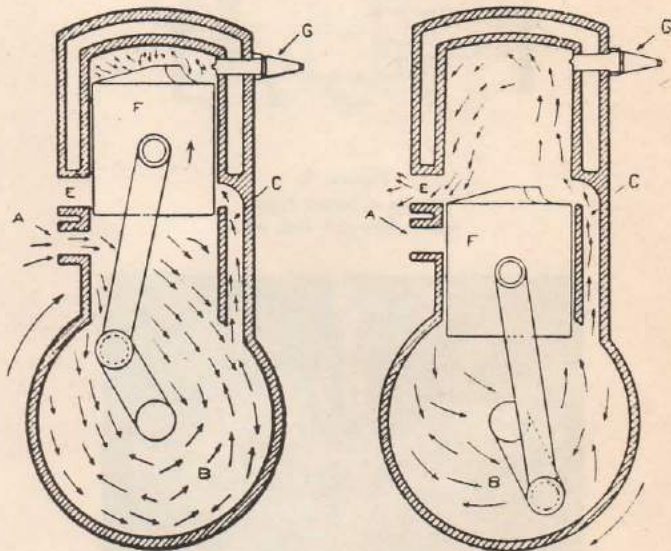

Figure 1

Figure 2

Fig. 1 (left). When piston (F) travels up, a charge of fuel vapor in cylinder is being compressed; at the same time a partial vacuum is created in crankcase (B). As piston progresses in its upward movement, intake port (A) is uncovered by the piston, and fuel vapor from carburetor (not shown) flows into crankcase. At the end of compression stroke, a spark from the spark plug (G) ignites the compressed fuel vapor in cylinder. The vapor in burning expands rapidly, forces piston downward, delivering power.

Fig. 2 (right). When piston (F) travels down on power stroke, intake port (A) is closed by the piston, and a pressure is formed in crankcase. A little farther down the piston starts to uncover exhaust port (E) emitting burned gases to the atmosphere. On its continued downward movement, the fuel vapor in crankcase is compressed until piston nears the end of the downward stroke, when the by-pass port (C) is uncovered by the piston. This instantly releases the compressed crankcase charge which flows through by pass (C) into cylinder, being directed upward by the piston deflector or baffle.

In engines of this type oil must be mixed with the gasoline in order to lubricate the moving parts. Lubrication instructions for all models are shown on page 83.



**POWER HEAD ASSEMBLIES**

Figures 3, 4 and 5 show typical Evinrude and Elto power head assemblies of connecting rods, pistons, crankshaft and crankcase.

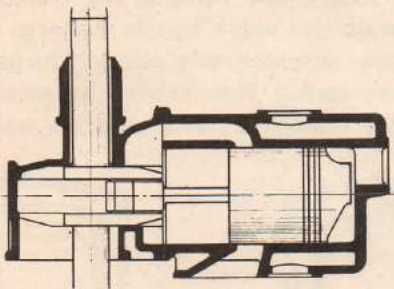

**Figure 3**  
Single cylinder type:  
Mate, Ranger, Pal, etc.

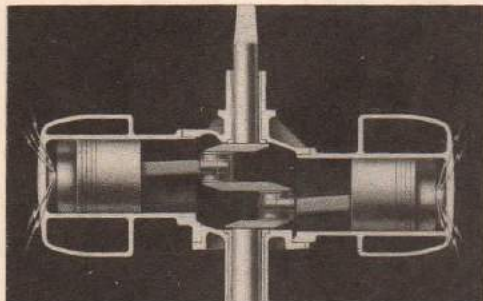

**Figure 4**  
Twin opposed type:  
Sportwin, Speeditwin, etc.

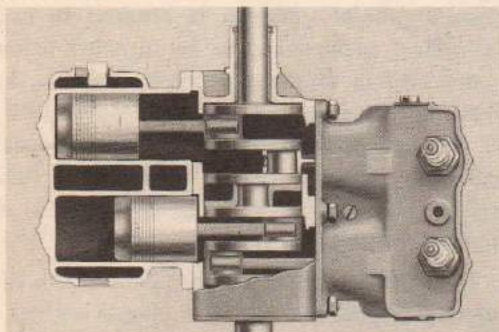

**Figure 5**  
Four cylinder type:  
Zephyr, Lightfour, etc.

**SECTION V**

**INSTALLATION OF MOTORS ON BOATS**

Hang the motor over the stern of the boat, preferably in the center. Tighten clamp screws securely (see Figure 11) with the fingers. Use no tools for this purpose. Finger pressure is sufficient. Besides turning the clamp screw (s) tight, it is "good insurance" to fasten one end of a piece of rope to the boat and to tie the other end to the motor. A motor so fastened cannot

get away if for any reason it goes overboard. Use slot provided (in large models) at bottom of bracket for lag screw to be placed in transom of boat.

If angle adjustment does not permit an absolutely vertical position, the drive housing should be moved in toward the boat. Remove wing nuts on angle adjustment bolt, which passes through holes in boat bracket and remove bolt, using next adjusting hole to bring drive housing into closest vertical position, preferably with housing toward stern of boat. If the stern of your boat is too vertical to permit the drive housing to reach a vertical position, remove angle adjusting bolt entirely.

**HIGH SPEED, PLANING TYPE BOATS**

For best results, the cavitation plate (C) should be about one inch lower than that part of the keel of the boat nearest the motor. If the motor hangs lower than this, operation will be generally satisfactory, but maximum speed will be somewhat reduced.

Best performance and speed is obtained when the keel is modified as shown in Figure 7. So removing a portion of the keel will in no way interfere with operation, will eliminate formation of spray and provide more efficient, free-running action. It also makes launching from a beach somewhat easier.

Recommended boat transoms:

A. (See Figure 6.) A 12° angle is preferable and conforms to the S.A.E. standard for boat transoms.

B. The transom thickness should not exceed the S.A.E. standard of 1 3/4". All Evinrude and Elto motors are built to conform to these S.A.E. standards.

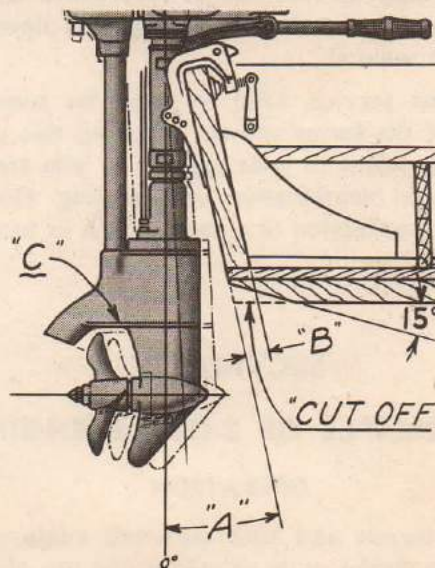

**Figure 6**

**DISPLACEMENT TYPE BOATS, WITH FULL OR CUTAWAY STERNS**

With motor on an empty boat, the drive housing (motor shaft) should be vertical and the propeller and



cavitation plate submerged so as to insure against cavitation. The stern must be cut down if necessary, and if proper depth cannot be secured by so doing, a 5 inch longer shaft motor which we have available at moderate extra cost should be used.

### BOAT AND MOTOR SELECTOR

Owners' complaints are sometimes due to mismatched motors and boats. Refer to our Boat and Motor Selector (gladly supplied on request) to determine which motors are suitable as power on various types of boat hulls.

### TO ELIMINATE UNDESIRABLE "ROOSTER TAILS"

In the process of our experimental work in actual boat operation with motors of different makes, from sixteen to thirty-three horsepower, mounted on large free-running and planing boats of different makes, it was discovered that at high speeds a heavy spray developed at the stern. At times this spray was sufficiently heavy to interfere with motor operation. Besides, the spray is objectionable to passengers and spectators. A better impression of clear, free-running action is given when this spray is not evident.

Our exhaustive tests disclosed this spray was produced only on boats where the substantial depth of the keel extended to the extreme rear end of boat. After thorough testing we were able to completely eliminate this objectionable spray by tapering the keel at the transom. This condition also causes underwater exhaust to "bark" into the open air, creating a noisy motor.

The sketch below shows how to modify the construction to eliminate the spray.

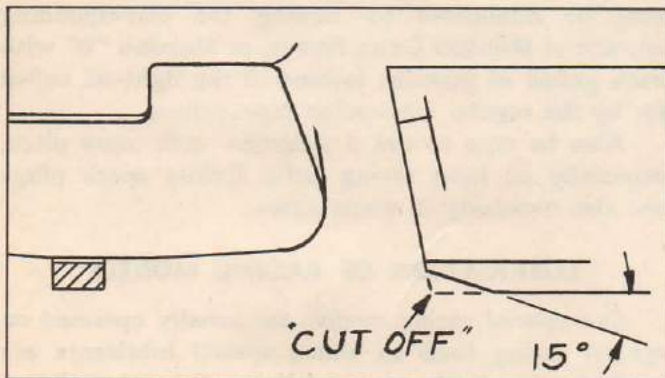

Figure 7

Removing portion of keel as indicated will in no way interfere with handling of boat, and will make launching from a beach somewhat easier.

We have sent all boat builders, whose names we had available, this information in the hope that they will heed our recommendation to change their keel constructions in this simple way.

We recommend that you make the simple change required on any hulls you may have in stock, and that you similarly change or recommend to be changed, boats being used by your customers with motors of 16 or more horsepower. We feel sure that they will appreciate your interest which will enable them to obtain better operation.

### FAILURE OF FUEL TANK TO DRAIN COMPLETELY

Occasionally owners of Zephyr, Lightfour, Sportwin and Sportfour motors complain that the tanks on these motors do not drain completely while in operation. Advise such owners to adjust the motor on the boat so that the motor is in a vertical position while the boat is in motion. It is also well to keep boat load well balanced, especially when fuel level is low in tank in order to keep fuel flowing steadily.

### ASSEMBLY OF MOTORS SHIPPED IN TWO SECTIONS

When the motor is shipped in two sections, it is taken apart at the gear housing flange. After removing motor from box, fasten lower section of gear housing to drive housing by means of two nuts, making sure square end of lower drive shaft enters coupling on upper drive shaft. CAUTION: Be sure flange nuts are tight!

### ASSEMBLY INSTRUCTIONS

1. Before motor is packed for shipment a small quantity of oil is inserted in the cylinders of the motor through the spark plug holes as a rust preventative. This oil should be removed from cylinders before any attempt is made to operate the motor.

To remove oil from cylinders of motor remove corks from spark plug holes in cylinders and, before inserting spark plugs, coil starter rope around starter disc on top of flywheel and spin motor several times. A teaspoonful of clear gasoline in each cylinder helps dissolve congealed oil. When proceeding as above the spark plug wires from magneto should be grounded to some part of motor.

2. Remove motor hood and insert spark plugs from tool kit in cylinders, and be sure to draw up tight with wrench. Loose plugs will cause pre-ignition and piston trouble.

### ATTACHING WIRES TO SPARK PLUGS

When attaching the high tension wire from the magneto to the spark plugs, place in position as shown in Figure 8 and tighten spark plug nut securely with pliers. On hooded models make sure that wire or terminal will not short on hood. On unhooded models strip rubber spark plug hoods over high tension wires, attach terminal to plug and cover with rubber hood.



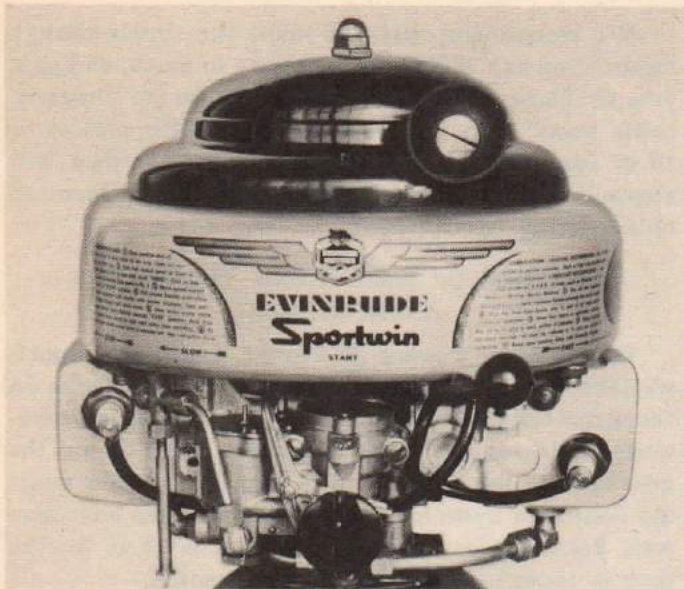

Figure 8

### REMOVING MOTOR FROM BOAT

When removing motor from boat, pull motor straight up and hold in vertical position until all water has drained from the underwater exhaust tube and water system. Never set motor on magneto or carry motor with magneto down, as this may allow water to enter the powerhead from the muffler. When laying motor down, see that carburetor is up; also that storage place is free from sand and grit.

## SECTION VI

### LUBRICATION INSTRUCTIONS — POWER HEADS

Lubrication is the most important factor in the operation of internal combustion engines—correct lubrication insures long life and satisfactory performance, whereas incorrect lubrication invariably results in premature wear and unnecessary expense.

Correct mixing and correct grades of gasoline and oil are very important. Don't believe that any grade or mixture will do. Your outboard is a two-cycle motor and lubrication of the cylinders, pistons, crankshaft and connecting rod bearings is supplied by mixing the lubricating oil with the gasoline. **NEVER POUR CLEAR GASOLINE OR OIL INTO THE TANK.**

**GASOLINE RECOMMENDED:** A good grade of regular gasoline is entirely satisfactory. Ethyl or high test gasoline can also be used, but gives no added advantage.

**LUBRICANT RECOMMENDED:** We recommend the use of a high grade oil of S.A.E. No. 30 body, such as Mobiloil "A," or Mobiloil Marine Heavy Medium.

Always mix the ingredients thoroughly in a clean can. It is dangerous to attempt to mix the ingredients

in the motor tank as the oil will settle to the bottom before becoming thoroughly mixed with the gasoline, clogging the fuel line and carburetor. A fuel can like the one shown in Figure 9 is a worth while investment for any outboard dealer and owner.

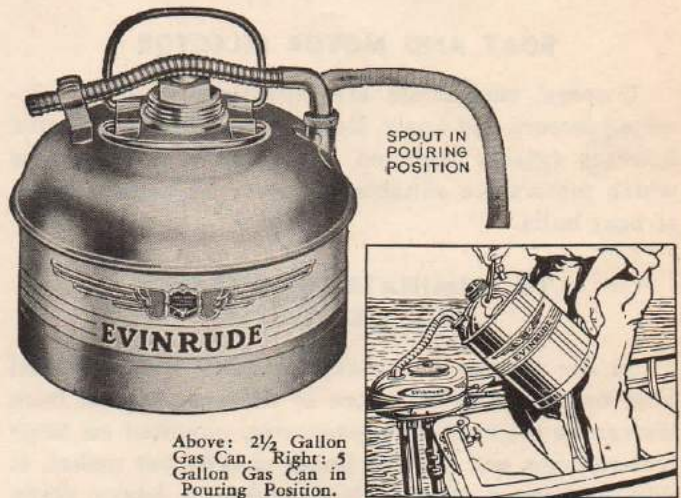

Above: 2 1/2 Gallon Gas Can. Right: 5 Gallon Gas Can in Pouring Position.

Figure 9

### USE OF HEAVIER OILS

Except in emergencies, oils heavier in viscosity than those specified should not be used, since they will cause spark plugs to foul and excessive carbon to form, clogging ring grooves, exhaust ports and mufflers.

### SERVICE MOTOR RACING

We constantly warn against the use of service motors in racing. The use of the engine for racing voids our warranty.

However, when a service motor is used for racing (resulting in increased revolutions) the injurious effect may be minimized by mixing the corresponding amount of Mobiloil Extra Heavy, or Mobiloil "B" with each gallon of gasoline instead of the light oil called for by the regular lubrication instructions.

Also be sure to use a propeller with more pitch, especially on light racing hulls. Colder spark plugs are also necessary in many cases.

### LUBRICATION OF RACING MODELS

Our special racing models are usually operated on special racing fuels in which special lubricants are used. As the usual commercial oil lubricants will not mix with these fuels, the special lubrication instructions supplied by the respective fuel manufacturers should be strictly followed.

When such special racing models are operated on gasoline the following lubrication instructions should be followed:

Class "M" Midget—1 1/2 Pts. S.A.E. No. 60 per gallon of gasoline.



Class "C" Speeditwin—1 Qt. S.A.E. No. 60 per gallon of gasoline.

Class "F" "460"—1 Qt. S.A.E. No. 60 per gallon of gasoline.

**CONFUSION ABOUT FUEL**

Confusion about fuel seems to prevail on the part of some Evinrude-Elto owners, and this is written to enable you to help eliminate this confusion.

In some way the impression seems to have gained ground that in order to secure satisfactory performance of an outboard motor, it is desirable to use only "clear" gasoline; that is, gasoline which does not contain lead (Ethyl). Others seem to be under the impression that best outboard performance is obtainable only through the use of "high test" or airplane gasoline.

Our fuel instructions as they appear on the gasoline tanks of our motors and in our instruction booklets read as follows:

A good grade of "regular" gasoline is entirely satisfactory. Ethyl or High Test gasoline can also be used, but gives no added advantage.

By the term "regular" is meant any readily obtainable automobile gasoline. The mere fact that it is colored, contains lead, or is sold under various advertising names, should not discourage you from using it in your outboard. Even the lowest priced grade containing lead (Ethyl) will be found satisfactory for outboard operation and easy starting.

High test and airplane fuels usually selling at premium prices will operate in outboards, but are actually not recommended or as satisfactory for their operation as are "regular" automobile fuels.

High test gasolines which are sold for easy automobile starting in cold weather have a much greater tendency to load or flood an outboard motor, particularly in hot weather, or when the motor is warm from previous operation. Naturally we cannot recommend such fuels, particularly when ordinary low test "regular" gasolines start our outboards just as readily.

Clear, straight-run white gasoline is no longer readily obtainable. It offers no advantage in outboard operation, so don't bother to locate it.

Contrary to claims sometimes advanced, our extensive tests show no injury, clogging or corrosion of any outboard parts from leaded (ethylized) gasolines, except when leaded gasoline is allowed to stand in a carburetor for a period of three or four months which generally occurs during the winter months when the motor is not laid up properly. In order to clean out the carburetor it is advisable to use alcohol which will dissolve the particles of white powder remaining in the bowl.

**LUBRICATION INSTRUCTIONS —  
LOWER UNITS**

**GREASING:** Keep the gear housing filled with

Evinrude Gear Grease. To fill, remove both plugs in housing and insert grease gun or grease tube in hole marked GREASE. Other hole relieves air pressure and permits water to drain out. Greasing will not be thorough unless both plugs are removed. Re-insert plugs securely. In cold weather, should your motor start hard because grease has become stiff, remove some of the grease and mix the remainder with good lubricating oil. This should not be necessary when the motor is thoroughly run in, or in warm weather.

**HEAVY DUTY REDUCTION GEAR**

Keep the gear housing filled with heavy mineral oil of S.A.E. 70 viscosity or fluid water-proof grease. To fill, remove both plugs and drain gear housing completely of old oil and accumulated water. Replace lower plug and fill gear housing completely with S.A.E. 70 oil or fluid grease. Reinsert upper plug; make sure both plugs are tight.

**SECTION VII**

**INSTRUCTIONS FOR QUICK TUNE-UP  
OF MOTORS**

When motors are brought to you for "check-up," first listen carefully to the operator's story of performance. Question him in detail, if necessary. If you are familiar with motors, consult the Trouble Chart, page 89, to help locate the source of the trouble.

Some owners bring in motors, not because of any specific trouble, but because they want to be sure that everything's ship-shape. Such customers are entitled to a thorough check-up. Sometimes a brand new motor will be brought in simply because the owner has failed to follow the operating or lubricating instructions carefully. The routine of procedure will vary somewhat, but here is a complete procedure to follow:

1. If motor runs, but with some fault, try it on test tank. Consult Trouble Chart if necessary. See whether pump is supplying cooling water.
2. Check whether spark plugs are correct type. Clean plugs and adjust points with gauge. (See page 25.)
3. Check ignition points, and clean and adjust if necessary. (See pages 25 and 26.)
4. Examine fuel mixture if necessary, in tank. If too lean, motor may have become damaged through lack of sufficient oil. Remove fuel screen, clean tank thoroughly. Check connections. Clean fuel line.
5. If motor runs sluggishly or keeps running with ignition shorted, it may indicate that the spark plugs are too "hot" for the particular type of service, or that excessive carbon may have accumulated in cylinders and ports, necessitating



5. Pull starting rope forcibly. Repeat until motor starts.
6. After motor starts, move speed control lever slightly to the right, then move mixture lever slowly to the right until motor runs smoothly. To control speed, move speed control lever to the right for FAST and to the left for SLOW.
7. For continued slow or trolling speed operation, it may be advisable to readjust mixture by moving mixture lever slightly towards "LEAN" position.
8. To stop motor, move the speed control lever to the extreme left.

**CAUTION:** For the first four hours of operation do not run motor faster than two-thirds the maximum speed.

### **RANGER**

(Insert spark plug [found in tool kit] in cylinder, and attach wire from magneto.)

1. Open gasoline shut-off valve located at left hand side of motor hood all the way. Open air vent screw in filler cap. Coil starting rope clockwise around starter disc. (On motors equipped with Simplex Starter no starting rope is required.)
2. Move speed control lever located directly beneath gasoline tank to "START" position, as indicated on fuel tank.
3. Move mixture lever to the extreme left in line with word "PRIME" — hold in this position about 8 to 10 seconds, and then move to number four (4) on dial.
4. Pull starting rope forcibly. Repeat until motor starts.
5. After motor starts, move speed control lever slightly to the right toward "FAST" position, then move mixture lever slowly to the right, until motor runs smoothly.
6. To stop motor, move speed control lever to extreme left.

**CAUTION:** For the first four hours of operation do not run motor faster than two-thirds the maximum speed.

### **PAL**

(Insert spark plug [found in tool kit] in cylinder, and attach wire from magneto.)

1. Open gasoline shut-off valve at left hand side of tank all the way. Open air vent screw in filler cap. Coil starting rope clockwise around starting disc.
2. Move mixture lever to left in line with Number 4 on dial.
3. Move speed control lever slightly to the right of center.
4. Press carburetor float pin down until gasoline flows through pin hole. Raise priming button on bottom of carburetor, pressing down on carburetor float pin at same time—hold in this position 8 to 10 seconds—then release.

5. Pull starting rope forcibly. Repeat until motor starts.
6. After motor starts, move speed control lever slightly to the right, then move mixture lever slowly to the right until motor runs smoothly. To control speed, move speed control lever to the right for FAST and to the left for SLOW.
7. For continued slow or trolling speed operation, it may be advisable to readjust mixture by moving mixture lever slightly towards "LEAN" position.
8. To stop motor, move the speed control lever to the extreme left.

**CAUTION:** For the first four hours of operation do not run motor faster than two-thirds the maximum speed.

### **SPORTSMAN**

(Insert spark plug [found in tool kit] in cylinder, and attach wire from magneto.)

1. Open gasoline shut-off valve below tank at left hand side of motor all the way. Open air vent screw in filler cap at top of tank wide open. Coil starting rope clockwise around starter disc on top of fly-wheel. (On motors equipped with Simplex starter, no starter rope is required.)
2. Move mixture lever at front of motor to the extreme left, in line with word "Prime," hold in this position about 8 to 10 seconds, and then move to number four (4) on dial.
3. Move speed control lever located directly beneath gasoline tank to "START" position as indicated on tank transfer.
4. Pull starter rope forcibly with right hand. Repeat until motor starts. A sluggish pull will not start motor. On motors equipped with Simplex Starter, pull starter handle protruding above gasoline tank slowly until starter engages, then pull forcibly. Repeat until motor starts.
5. After motor starts, move speed control lever slightly to the right, toward "FAST" position, then move mixture lever slowly to the right, until motor runs smoothly. To control speed, move speed control lever to the right for FAST and to the left for SLOW.
6. For continued slow or trolling speed operation, it may be advisable to readjust mixture by moving mixture lever slightly towards "LEAN" position.
7. To stop motor, move the speed control lever to the extreme left.

**CAUTION:** For the first four hours of operation do not run motor faster than two-thirds the maximum speed.

### **ACE**

(Insert spark plug [found in tool kit] in cylinder, and attach wire from magneto.)

1. Open gasoline shut-off valve at left hand side of tank all the way. Open air vent screw in filler cap. Coil starting rope clockwise around starting disc.



2. Move mixture lever to left in line with Number 4 on dial.
3. Move speed control lever slightly to the right of center.
4. Press carburetor float pin down until gasoline flows through pin hole. Raise priming button on bottom of carburetor, pressing down on carburetor float pin at same time—hold in this position 8 to 10 seconds—then release.
5. Pull starting rope forcibly. Repeat until motor starts.
6. After motor starts, move speed control lever slightly to the right, then move mixture lever slowly to the right until motor runs smoothly. To control speed, move speed control lever to the right for FAST and to the left for SLOW.
7. To stop motor, move the speed control lever to the extreme left.

**CAUTION:** For the first four hours of operation do not run motor faster than two-thirds the maximum speed.

### **SPORTWIN**

(Remove motor hood, then insert spark plugs [found in tool kit] in cylinders, and replace hood.)

1. Open gasoline shut-off valve below front of motor hood all the way. Open air vent screw in filler cap at top of tank wide open. Coil starting rope clockwise around starter disc on top of flywheel. (On motors equipped with Simplex Starter, no starter rope is required.)
2. Move fuel control lever at front of motor hood to the left, in line with word "Prime"; hold in this position 5 seconds, then move to Number 4.
3. Move speed control lever located directly beneath gasoline tank to "START" position as indicated on tank transfer.
4. Pull starter rope forcibly with right hand. Repeat until motor starts. A sluggish pull will not start motor. On motors equipped with Simplex Starter, pull starter handle protruding above gasoline tank slowly until starter engages, then pull forcibly. Repeat until motor starts.
5. After motor starts, move speed control lever slightly to the right, toward "FAST" position, then move fuel control lever slowly to the right, until motor runs smoothly. To control speed, move speed control lever to the right for FAST and to the left for SLOW.
6. To stop motor, move speed control lever to extreme left.

**CAUTION:** For the first four hours of operation do not run motor faster than two-thirds the maximum speed.

### **HANDITWIN**

(Insert spark plugs [found in tool kit] in cylinders, and attach wire from magneto.)

1. Open gasoline shut-off valve at lower left hand

corner of tank all the way. Open air vent screw in filler cap at top of tank, wide open. Coil starting rope clockwise around starting disc on top of flywheel.

2. Move mixture lever approximately 45° to the right of center.
3. Move speed control lever (directly beneath flywheel) slightly to the right of center.
4. Press carburetor float pin down until gasoline flows through pin hole. Raise priming button on bottom of carburetor, pressing down on carburetor float pin at same time until gasoline drips through screen at bottom of air intake.
5. Pull starting rope forcibly with right hand. Repeat until motor starts. A sluggish pull will not start motor.
6. After motor starts, move speed control lever slightly to the right, then move mixture lever slowly to the left until motor runs smoothly. To control speed, move speed control lever to the right for FAST and to the left for SLOW.
7. To stop motor, move speed control lever to extreme left.

**CAUTION:** For the first four hours of operation do not run motor faster than two-thirds the maximum speed.

### **LIGHTWIN**

(Insert spark plugs [found in tool kit] in cylinders, and attach wire from magneto.)

1. Open gasoline shut-off valve at lower left hand corner of tank all the way. Open air vent screw in filler cap at top of tank, wide open. Coil starting rope clockwise around starting disc on top of flywheel.
2. Move mixture lever approximately 45° to the right of center.
3. Move speed control lever (directly beneath flywheel) slightly to the right of center.
4. Press carburetor float pin down until gasoline flows through pin hole. Raise priming button on lower right hand side of carburetor, pressing down on carburetor float pin at same time until gasoline flows through screen at bottom of air intake.
5. Pull starting rope forcibly with right hand. Repeat until motor starts. A sluggish pull will not start motor.
6. After motor starts, move speed control lever slightly to the right, then move mixture lever slowly to the left until motor runs smoothly. To control speed, move speed control lever to the right for FAST and to the left for SLOW.
7. To stop motor, move speed control lever to extreme left.

**CAUTION:** For the first four hours of operation do not run motor faster than two-thirds the maximum speed.



**ZEPHYR**

(Remove motor hood and insert spark plugs [found in tool kit] in cylinders. Connect wires and replace hood.)

1. Move timer (spark control) lever, located beneath gas tank, to "START" position as indicated on tank transfer.
2. Coil starter rope clockwise around starter disc. (Motors equipped with Simplex Starter require no starter rope.)
3. Turn control grip on steering handle so word "START" is in line with arrow on edge of steering handle.
4. When starting COLD MOTOR turn fuel control lever at front of motor hood to left, in line with word "PRIME." Hold in this position about 5 seconds, then turn to "START COLD" position.
5. Pull starter rope forcibly with right hand. Repeat until motor starts.
6. After motor starts, turn fuel control lever gradually toward RUN position and move timer lever to the right toward "FAST" position. To increase speed, open throttle by turning grip towards word "FAST." To decrease speed, turn grip towards "SLOW." Also use timer lever to retard spark for extremely slow speed. RIGHT is advance, LEFT is retard.
7. To stop motor press cut-out spring on timer lever. When motor is not in operation turn fuel control lever to extreme right to "SHUT-OFF" position.
8. When starting WARM MOTOR do not prime but turn fuel control lever to "RUN" position and turn grip on steering handle to "START" position.
9. Although both high and low speed mixture valves at front of motor hood directly beneath fuel control lever are adjusted at factory, these for best operation should be adjusted under actual running conditions.

After motor has been warmed up, turn control grip to "SLOW" position and retard spark by moving timer lever towards word "SLOW." Now with a screw driver turn low speed mixture valve, located to the left, slowly in or out until motor runs smoothly.

After best slow running setting has been obtained, move timer lever to "FAST" position, also turn control grip towards "FAST." Now adjust high speed mixture valve located to the right, by slowly turning in or out until best operating setting has been obtained.

The approximate setting of the low speed mixture valve is 1 turn from closed position and of the high speed mixture valve 1/2 turn from closed position.

Always adjust low speed mixture valve first and do not change this setting when adjusting high speed valve.

**CAUTION:** To eliminate the necessity of readjusting the high and low speed mixture valves every

time motor is used it is advisable to measure the quantity of lubricating oil mixed with the gasoline very accurately. Care should also be taken that the same grade and type of both oil and gasoline are always used.

**CAUTION:** For the first four hours of operation do not run motor faster than two-thirds the maximum speed.

**FLOODING**—It sometimes happens that too much gasoline is drawn into the crankcase and cylinders when starting motor, especially when the motor is warm. When this occurs, the charge cannot be fired, as the mixture is too rich to be explosive, therefore this excess gasoline must be eliminated.

To do this, first note setting of needle valve(s) on carburetor so these can be returned to readily, then gently close needle valves and pull starter rope until motor starts, allowing motor to run until it stops. Now, reset needle valve(s) and follow instructions relative to starting WARM motor.

**LIGHTFOUR**

(Remove motor hood and insert spark plugs [found in tool kit] in cylinders. Connect wires and replace hood.)

1. Move timer (spark control) lever, located beneath gas tank, to "START" position as indicated on tank transfer.
2. Coil starter rope clockwise around starter disc. (Motors equipped with Simplex Starter require no starter rope.)
3. Turn control grip on steering handle so word "START" is in line with arrow on edge of steering handle.
4. When starting COLD MOTOR turn fuel control lever at front of motor hood to left, in line with word "PRIME." Hold in this position about 5 seconds, then move to "START COLD" position.
5. Pull starter rope forcibly with right hand. Repeat until motor starts.
6. After motor starts, turn fuel control lever gradually toward RUN position and move timer lever to the right toward "FAST" position. To increase speed, open throttle by turning grip towards word "FAST." To decrease speed, turn grip towards "SLOW." Also use timer lever to retard spark for extremely slow speed. RIGHT is advance, LEFT is retard.
7. To stop motor press cut-out on timer lever. When motor is not in operation turn fuel control lever to extreme right to "SHUT-OFF" position.
8. When starting WARM MOTOR do not prime but move fuel control lever to "RUN" position and turn grip on steering handle to "START" position.
9. Although both high and low speed mixture valves at front of motor hood directly beneath fuel control lever are adjusted at factory, these for best opera-



tion should be adjusted under actual running conditions.

After motor has been warmed up, turn control grip to "SLOW" position and retard spark by moving timer lever towards word "SLOW." Now with a screw driver turn low speed mixture valve, located to the left, slowly in or out until motor runs smoothly.

After best slow running setting has been obtained, move timer lever to "FAST" position, also turn control grip towards "FAST." Now adjust high speed mixture valve located to the right, by slowly turning in or out until best operating setting has been obtained.

The approximate setting of the low speed mixture valve is 1 turn from closed position and of the high speed mixture valve 1/2 turn from closed position.

Always adjust low speed mixture valve first and do not change this setting when adjusting high speed valve.

**CAUTION:** To eliminate the necessity of readjusting the high and low speed mixture valves every time motor is used it is advisable to measure the quantity of lubricating oil mixed with the gasoline very accurately. Care should also be taken that the same grade and type of both oil and gasoline are always used.

**CAUTION:** For the first four hours of operation do not run motor faster than two-thirds the maximum speed.

### FLEETWIN

1. Open shut-off valve at lower left hand corner of gasoline tank to horizontal position. (Lever is in line with gasoline pipe when open.) Open air vent screw in filler cap at top of tank, wide open.
2. Turn high speed mixture valve on left hand side of carburetor to closed position, then open 2 1/2 turns.
3. Move timer (spark control) lever (directly beneath flywheel) to a position about 15 degrees to the right of center.
4. Turn control grip on steering handle, so that word "START" is in line with arrow on edge of steering handle. This will set carburetor throttle to "START" position. Press down plunger on top of carburetor 2 or 3 times.
5. Coil starting rope clockwise around starting disc on top of flywheel and pull rope forcibly with right hand. Repeat until motor starts.
6. When motor starts, advance timer lever by moving to right. Open carburetor throttle by turning control grip on steering handle toward the word "FAST" and slowly close high speed mixture valve until motor runs smoothly.
7. To control speed turn control grip on steering handle toward the word "FAST" for speed increase and toward the word "SLOW" for decrease. Also

move timer lever to right for "FAST," to left for "SLOW."

8. To stop motor, press cut-out spring on timer lever.

### SPORTFOUR

Remove motor hood and insert spark plugs from tool kit in cylinders.

1. Open gasoline shut-off valve at front of motor directly beneath carburetor all the way. Open air vent screw in filler cap on top of tank, wide open.
2. Replace motor hood and close high speed mixture valve protruding from front of motor hood, then open 1 1/2 turns so word "START" on mixture valve is in line with indicator mark on motor hood.
3. Move speed control lever, located beneath gas tank, to "START" position as indicated on tank transfer.
4. Coil starter rope clockwise around starter disk on top of flywheel.
5. Move steering handle grip so that word "START" is in line with the arrow. Press down primer lever at front of motor hood 4 or 5 times, making sure lever is moved as far to left as possible in direction of arrow on motor hood. Pull starter rope forcibly with right hand. A sluggish pull will not start motor.
6. After motor starts, move speed control lever to the right. When motor has warmed up, slowly close high speed mixture valve until motor runs smoothly. Observe position of indicator on motor hood in respect to number on mixture valve so that normal running setting can be noted and returned to readily.
7. To increase speed, turn steering handle grip towards the word "FAST;" to decrease speed, towards the word "SLOW;" also move speed control lever to right for "FAST," to left for "SLOW."
8. To stop motor, press cut-out on speed control lever.
9. When starting warm motor, mixture valve need not be changed from normal running setting, and primer should not be used unless motor does not start after second pull of starter rope, as excessive use of primer will cause motor to become flooded.
10. The low speed mixture valve located at lower right hand side of motor hood is adjusted at the factory. If motor does not idle properly adjust low speed mixture valve by turning control grip on steering handle to slow position and move speed control lever slowly to the left until motor runs at desired low speed. Now with a screw driver turn low speed mixture valve in or out until motor runs smoothly.

**CAUTION:** For the first four hours of operation do not run motor faster than two-thirds the maximum speed.

### SPEEDITWIN

(Insert spark plugs [found in tool kit] in cylinders



and attach wires from magneto. Attach spark plug hood to end of each cylinder so wires enter bottom of hood.)

1. Open gasoline shut-off valve at lower left hand corner of gas tank all the way. Open air vent screw in filler cap at top of tank wide open.
  2. Close high speed mixture valve by turning valve wheel protruding from top of motor hood to the left as far as it will go in line with No. 1. Open high speed mixture valve so that word "START" is in line with arrow on hood above valve wheel. Open low speed mixture valve on lower front of carburetor directly below motor hood, 1/2 turn from closed position.
  3. Move timer (spark control) lever in line with word "START" on front of motor hood.
  4. Coil starting rope clockwise around starting disc on top of flywheel.
  5. Turn control grip on steering handle so that word "START" is in line with arrow on edge of steering handle. This will set carburetor throttle to "START" position. Press down primer protruding from top of motor hood 3 or 4 times, forcing gas into crankcase for starting. Pull starter rope forcibly with right hand. Repeat until motor starts.
  6. After motor starts, move timer lever to the right and adjust high speed mixture valve until motor runs smoothly. To increase speed, open throttle by turning steering handle grip towards word "FAST." To decrease speed, turn grip towards "SLOW." Also use timer lever to retard the spark for extremely slow speed. RIGHT is advance, LEFT is retard.
  7. To stop motor, push cut-out button on timer lever.
  8. When starting WARM MOTOR leave mixture valve set for high speed and press primer 1 to 2 times. Coil rope around flywheel and start as above.
- CAUTION:** For the first four hours of operation do not run motor faster than two-thirds the maximum speed.

### SPEEDIFOUR

(Remove spark plug covers, insert spark plugs [found in tool kit] in cylinders and attach wires from magneto.)

1. Open gas shut-off valve at lower left hand corner of gas tank to horizontal position. Open air vent screw in filler cap at top of tank, wide open.
2. Open mixture valve three turns from closed position.
3. Move speed control lever slightly to the right of center.
4. Coil starting rope clockwise around starting disc on top of flywheel.
5. Turn control grip on steering handle so that word "START" is in line with arrow on edge of steering

handle. This will set carburetor throttle to "START" position. Move choke lever to right which also opens release valve on right hand cylinder. Pull starter rope forcibly with right hand. If motor does not start after three pulls on starter rope, move choke lever half way to left and pull starter rope. Repeat until motor starts.

6. After motor starts, close release valve by moving choke lever to left as far as possible. Move speed control lever to the right and adjust mixture valve until motor runs smoothly. To control speed, turn control grip on steering handle inward for FAST, outward for SLOW. Also use speed control lever to retard the spark for extremely slow speed. RIGHT is advance, LEFT is retard.
7. To stop motor, press cutout button at end of speed control lever.
8. To start warm motor choking may be unnecessary.
9. The mixture valve setting on carburetor should NEVER be changed when once properly set.

**CAUTION:** For the first four hours of operation do not run motor faster than two-thirds the maximum speed.

### ELECTRIC STARTING SPEEDIFOUR

1. Open gas shut-off valve at lower left hand corner of gas tank to horizontal position. Open vent in filler cap at top of gas tank wide open.
2. Open carburetor needle valve three turns from closed position.
3. Turn control grip on steering handle so that word "START" is in line with arrow on edge of steering handle.
4. Move choker lever on top of air horn to right. This will automatically open compression release valve.
5. Turn on ignition with key in ignition lock on right hand side of panel, by turning right to the "ON" position as marked.
6. Swing timer control and starting switch lever to the extreme right which engages the starter switch. This will automatically retard spark.
7. When motor starts, move timer control lever to left, which advances the spark, move choke lever to extreme left and adjust needle valve until motor runs smoothly. To decrease speed, move timer control lever to right, then turn control grip on steering handle toward the word "SLOW." To increase speed, move timer control lever to left, turn control grip on steering handle toward the word "FAST."
8. To stop motor turn key in ignition switch to the left.
9. To start warm motor choking may not be necessary.
10. The needle valve setting on carburetor should never be changed when once properly set.



11. The charge regulator switch, which is the toggle switch on the right hand side of the panel, should be left at "HIGH" at all times unless motor is used CONTINUOUSLY for several hours, when switch should be placed at "LOW."

## SECTION IX

### SUGGESTED PROCEDURE FOR DISMANTLING MOTORS

The outline below applies specifically to the Elto Ace motor—but with the added paragraphs below, covering Simplex Starters, hoods, and 4-cylinder motors, will serve for all models. The procedure must of course be varied to suit the repair job to be done, whether complete overhaul, power head or lower unit repair, etc. See Figure 11.

Keep a few small bread tins handy in which to store all small parts; (Figure 10) screws, nuts, etc., of a motor until it is ready for reassembly. Before storing such parts in your bin in case of delayed repairs put such parts in a perforated tin can in which they can conveniently be washed in gasoline or kerosene.

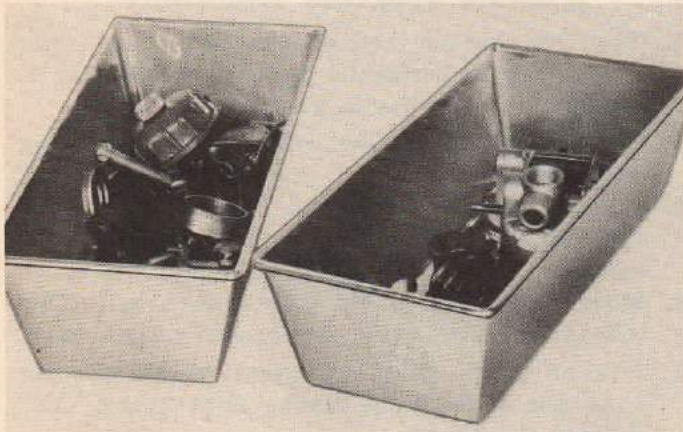

Figure 10

#### WHEN PARTS WON'T COME APART

Occasionally, after long use, particularly in salt water, it may be found difficult to remove certain parts because of corrosion or "freezing". In such cases we have discovered only two remedies that sometimes prove effective. For aluminum parts, expanding the larger or surrounding member by heating with a blow torch will often have the desired effect. In the case of steel or iron parts that have rusted together, thorough soaking with penetrating oil will often loosen up the joints to the point where they can be pulled apart without further damage.

1. Loosen flywheel nut about three turns, then pull up on flywheel while you strike the flywheel nut a sharp blow. This will loosen flywheel from taper on crankshaft. Remove flywheel nut and flywheel.

**NOTE:** On most Evinrudes gas tank must be removed before flywheel. (The use of a flywheel puller is strongly recommended. See Figure 28, page 31.)

2. Loosen armature friction screw and remove armature. Place armature in flywheel or, if armature is to be worked on, place piece of metal or large nail over magnets in flywheel so it will not lose its magnetism.
3. Remove gasoline pipe between gas tank and carburetor.
4. Remove gasoline tank.
5. Remove carburetor.
6. Remove muffler.
7. Remove cylinder screws and cylinder.
8. Remove lower crankcase screws and lift off crankcase with pistons and rods.
9. Remove connecting rod screws and connecting rod. Before cap is removed, mark cap so that the cap will be replaced in same position as removed.
10. Remove piston pin spring rings.
11. Remove piston pin.
12. Remove gear housing driveshaft tube screws and lock straps and remove gear housing.
13. Remove propeller nut and propeller.
14. Remove shear pin.
15. Remove gear housing cap screws and gear housing cap, and remove propeller shaft and gear.
16. Remove pump body screws.
17. Remove driveshaft assembly from gear housing.
18. Remove steering handle.
19. Remove clamp screws on pivot bearing and Copilot screw and remove drive tube.
20. Remove steering handle support.
21. Remove tilting bolt.
22. Remove carburetor float bowl cover and check and clean carburetor.

#### SIMPLEX STARTER

When the motor is equipped with Simplex Starter, this must first be removed. Loosen and remove three screws on starter housing. Lift off starter assembly, also spacers if present. Do not lose these.

#### REMOVAL OF MOTOR HOODS

When the motor is equipped with motor hood, loosen and remove cover screws. Lift off cover, remove it from motor without forcing or bending.

#### REMOVING CYLINDERS ON 4-CYLINDER MOTORS

Special care should be taken in removal of cylinders on the fours not to force or bend the connecting rods. Pull the cylinder straight out without exerting too much upward or downward pressure.



# EVINRUDE ZEPHYR

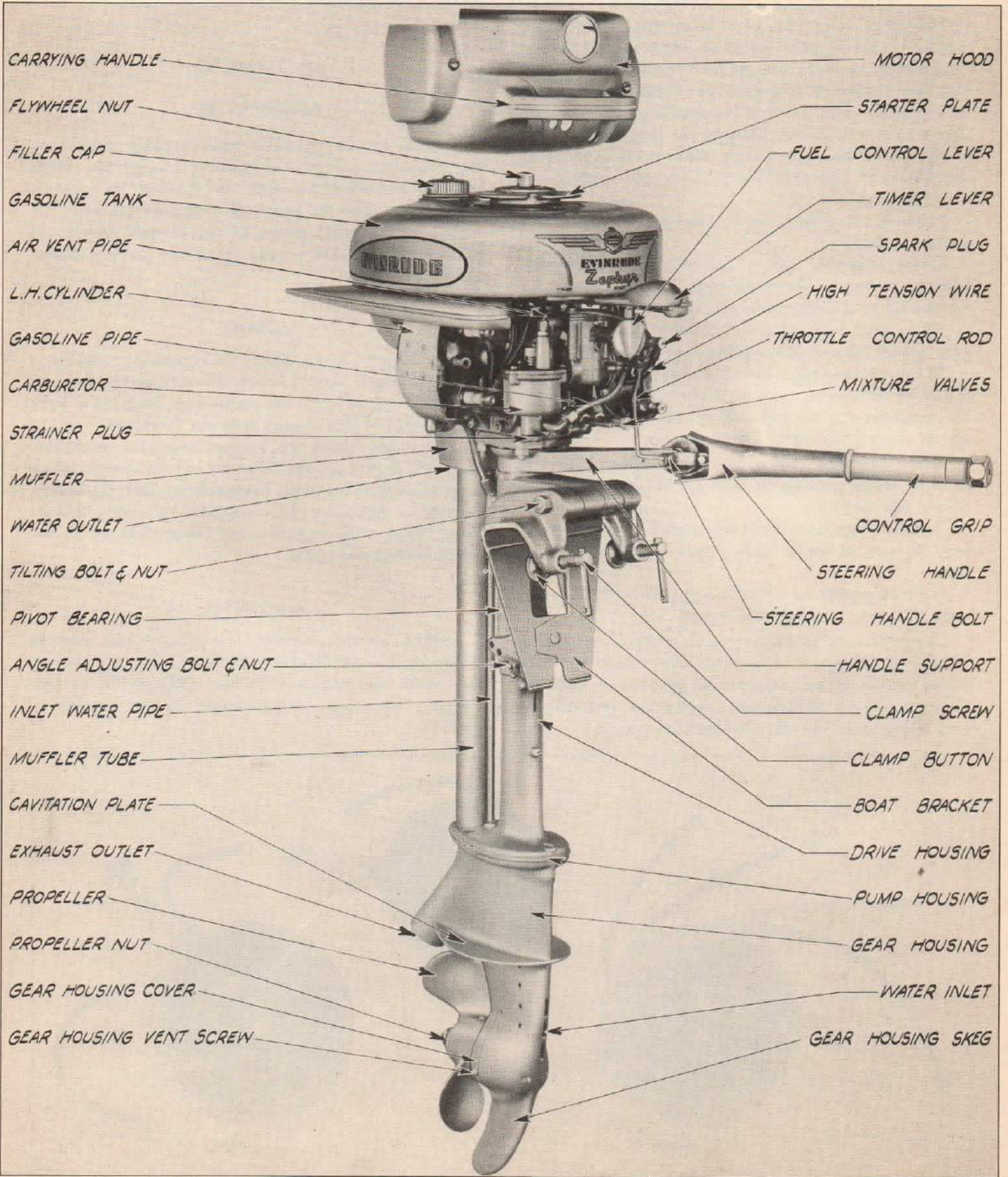

Figure 11



## SECTION X

### SIMPLE OVERHAUL PROCEDURE

Now that motor has been completely dismantled, clean all parts in clear gasoline, removing all carbon from piston, cylinder, and muffler. Check rings to see that they are free in ring grooves of pistons, also make sure relief holes in muffler and muffler tube are open. Check all bushings and parts to see that they are not worn. Check magneto points, clean with sand paper and adjust to .020 gap. Clean and check spark plugs and adjust to .025 gap.

Replace all gaskets and clean surface to which gaskets adhere.

Check propeller and if out of true, contact distributor or factory for re-pitching. If not out of true, remove all rough edges and replace.

Clean gear housing and refill with fresh Evinrude gear grease after reassembling.

When reassembling piston and cylinder put oil on piston as well as on cylinder walls and see that rings are compressed when entering cylinder. Do not spread oil on parts with dirty, gritty fingers.

After complete motor has been reassembled test in tank before putting on boat so that proper adjustments can be made.

If new rings have been installed it may be necessary to run in under belt power before testing on tank.

Be sure proper quantity and quality of oil is mixed with gasoline when testing motor.

If motor is to be stored, put in a dry place, wiping outside of motor with a cloth saturated with oil. Also put a couple of teaspoonfuls of pure oil in cylinder, through spark plug hole and revolve the flywheel several times to spread the oil over the cylinder.

Now wrap entire motor in a piece of canvas, an old blanket or in a piece of heavy paper and it will be ready to go when needed.

## SECTION XI

### MAGNETOS

Briefly, the magneto is a device capable of converting magnetic energy into electric energy by which some of the effort put into the flywheel or rotor is transformed into an electrical discharge between the points of the spark plugs at the instant ignition is desired. This spark occurs when the contact points open.

#### MAGNET

The magnet is charged to its maximum capacity at the factory and should retain this charge indefinitely. However, under some circumstances, such as a hard blow, some of the charge may be "knocked" out. In these extreme cases the magnet must be recharged. Magnets should always be inspected for cracks which may weaken them, both magnetically and physically. A magnet should not be considered as having lost its "pep" until such diagnosis has been made by an authorized representative.

#### MAGNETO

Below are shown three type of magnetos used on Evinrude and Elto motors. All are similar in construction with one, (Figure 12) two, (Figure 13) or four (Figure 14) leads corresponding to the number of cylinders.

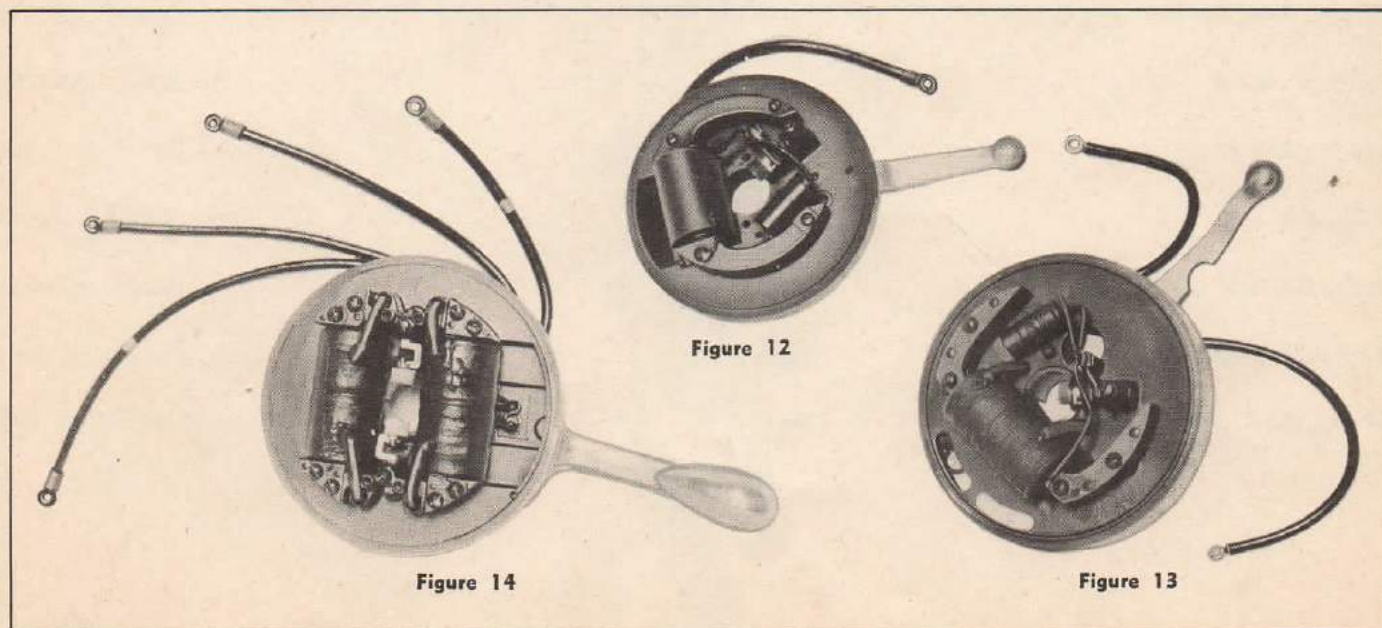



### FUNCTION OF CONTACT POINTS

On most models the timer pin rides against the crankshaft which has one side ground flat, giving the effect of a cam which opens and closes the contact points during operation. On the Sportfour, Speeditwin and Speedifour the cam is on the hub of the flywheel. The points open at the instant the spark is required at the spark plug(s) for firing the vapor in the cylinders.

### LUBRICATION

Apply a very small amount of grease to inside of clamp collar to prevent galling. This is important as a dry metal to metal contact here may cause galling and ultimate breakage of clamp collar. Also put a tiny bit of grease on the crankshaft or flywheel hub where it contacts the breaker arm plunger.

On most small type magnetos the cam is lubricated by a felt washer which should be re-oiled occasionally.

### TESTING THE SPARK

The magneto is of the high tension built-in-the-flywheel type. It is simple in construction and requires little, if any, attention. The only parts requiring occasional attention are the contact points.

To test the ignition, remove the spark plugs, attach magneto wires to plugs and lay them on the cylinders. Spin the flywheel with the starter rope, and see if a good spark is evident at the spark plug points. A weak spark may indicate a weak coil, condenser, dirty or broken spark plugs, or contact points dirty or out of adjustment.

If, after testing as above, the magneto delivers no spark at all, or a very weak spark, clean and adjust the spark plug points to .025 of an inch. (Figure 15.)

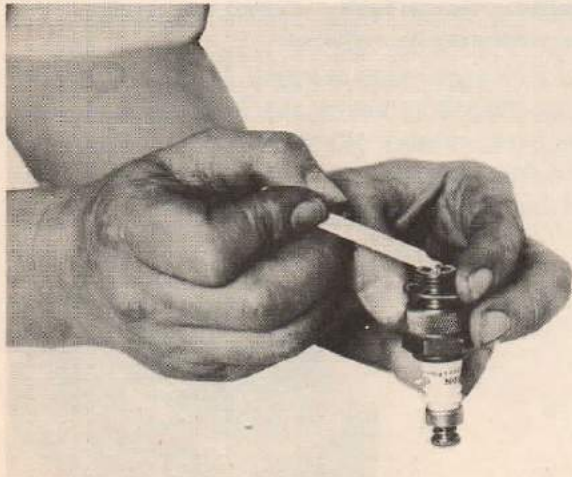

Figure 15

Then carefully check contact points (see instructions under "Adjustment of Magneto Contact Points," right.) If the contact points are clean and properly adjusted and not broken, check for broken wires or

loose connections. Next remove and check condenser or replace with new one. If magneto still delivers a weak spark, the coil should be checked. To assure proper checking of coil, the entire magneto should be sent to the factory or nearest dealer or service station. (See list of service stations on page 94.)

### SPARK PLUGS

For easy starting and best performance it is advisable to renew the spark plugs in an outboard motor every season. Now is the time to order your supply for the coming year.

More important is the use of the correct spark plug. We carry in stock the proper plugs for all motors which we have manufactured. Please refer to spark plug chart, page 85, for correct listing.

### BREAKER ASSEMBLY

#### TIMER PIN — BREAKER ARM

This is the principal moving part and if excessive wear is evident, replacement should be made.

#### SPRING

Any breakage, distortion or weakness of the breaker spring will warrant its replacement. The spring should be capable of holding points firmly in contact.

### ADJUSTING OF MAGNETO CONTACT POINTS

The magneto contact points may become dirty or out of adjustment. To check points it is necessary to remove flywheel. (See instructions page 31) (Figure 16) On Sportfour, Speeditwin and Speedifour models it is not necessary to remove flywheel. Re-

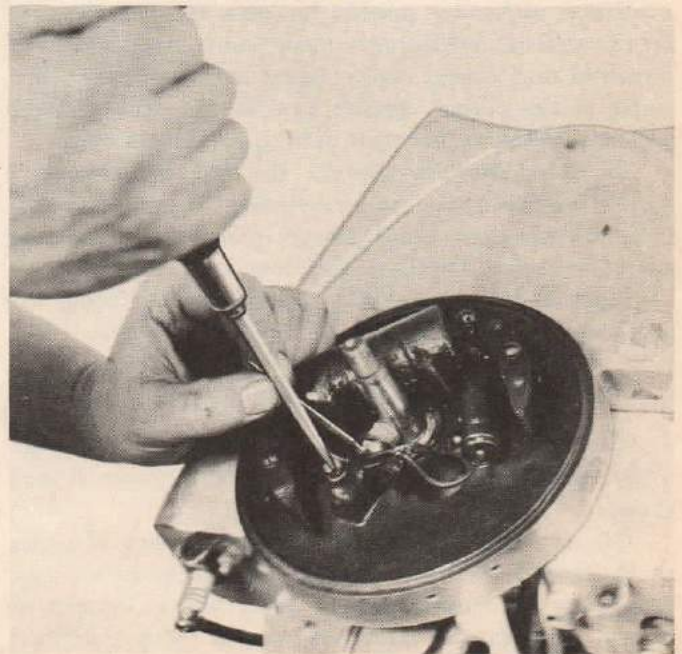

Figure 16



move starter plate on top of flywheel and adjust points through inspection hole in flywheel. (Figure 17)

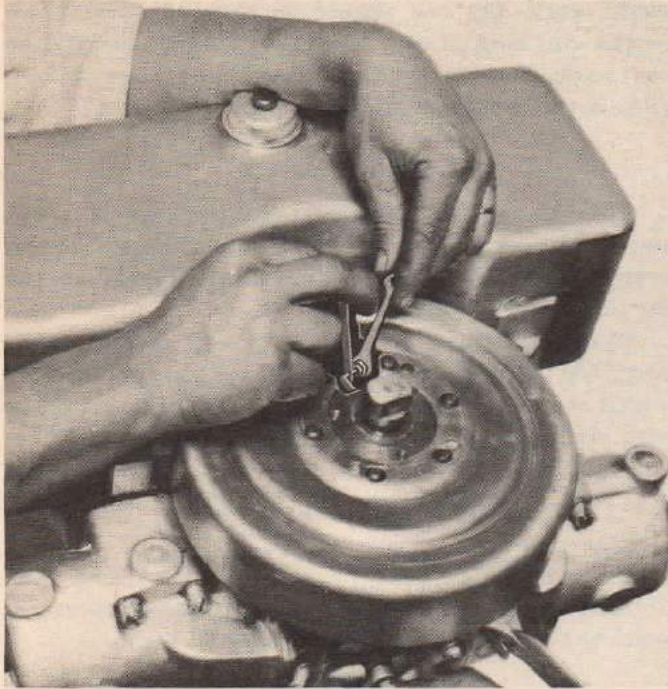

Figure 17

After the flywheel has been removed, place speed control lever in center position, directly above carburetor, and turn crankshaft so that fibre plunger of contact finger is riding on high point of crankshaft.

Loosen clamp screw directly above breaker and move breaker in toward crankshaft to open points and outward, away from the crankshaft, to close points. The contact points should open .020 of an inch. The finger on the gauge marked "Breaker Gap" shows the correct thickness.

When adjusting points, be sure to hold breaker arm in position with finger until point gauge has been removed and clamp screw tightened; otherwise, because of the spring tension against the cam, breaker arm slips back and correct setting cannot be made.

On four cylinder motors the left hand contact points fire the upper set of cylinders through the rear coil, and the right hand contact points fire the lower set of cylinders through the front coil.

Right and left hand is designated while facing the motor on the carburetor side.

### CLEANING CONTACT POINTS

Contact surfaces should be free from oil and clean. They should be adjusted for proper alignment and should be smooth.

Oil may be removed by drawing a piece of paper or cardboard between them, and rough or pitted surfaces may be conditioned by using fine sandpaper or emery cloth in the same manner, or with a contact point file.

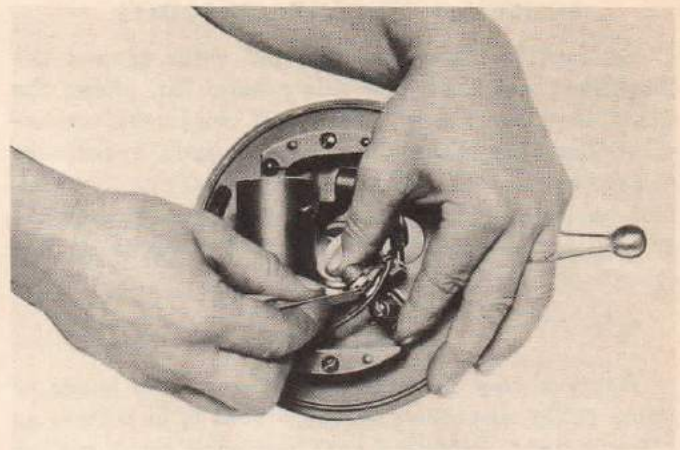

Figure 18

### INSTALLING NEW CONTACT POINTS

If the old points are too badly pitted, install new ones. These must be accurately adjusted to give positive contact. Failure to properly adjust the points will result in hard starting and faltering slow speed operation, or missing at high speed.

### CONDENSER

A weak spark may result from leaky condenser or an open condenser circuit.

#### WEAK CONDENSER

Badly burned ignition points after a short period of operation may indicate a weak condenser. Check condenser.

No spark at all will result from a shorted condenser.

#### TESTING THE CONDENSER

Condensers found faulty cannot be repaired and should immediately be replaced.

In our own repair shop we have been using a tester of the type illustrated below and have found it satisfactory in every respect. We have made arrangements with the manufacturers to supply us with these testers to enable us to offer them to our dealers.



Figure 19



This tester detects flaws in condensers by means of a neon flash tube which reveals short circuits, open circuits or dielectric leakage.

Part No. 275559—Condenser Tester.

**AN EFFICIENT "HOME-MADE" CONDENSER TESTER**

Hook up a D.C. circuit of not over 150 V, as shown in Figure 20. A good condenser will test as follows:

Attach condenser lead to "A." Meter needle will deflect and immediately drop back to zero, indicating charging of the condenser. Disconnect from "A" and wait fifteen minutes. Then connect to "B" and note needle deflection in opposite direction indicating discharge of condenser.

If, upon attachment to "B" there is no deflection, the charge has been dissipated within the condenser, indicating a leaky condenser that should be replaced.

A badly leaking condenser, when attached to "A" will cause needle to show a continuing deflection. A condenser in which the circuit is completely broken or open when attached to "A" will show no needle deflection whatever.

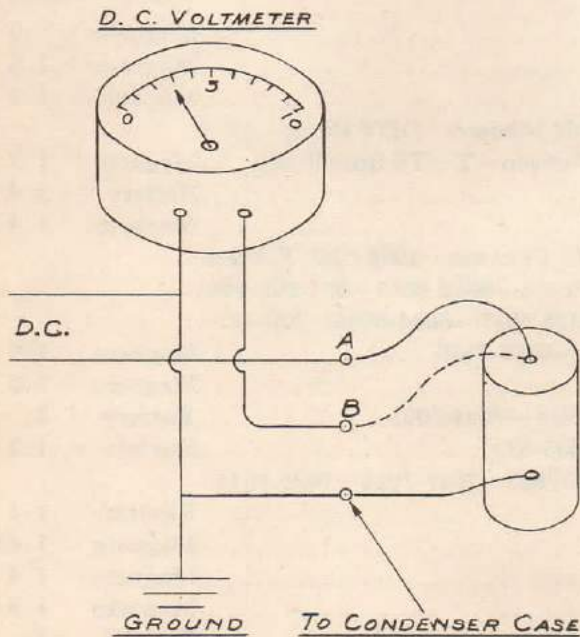

Figure 20

**COIL**

The coil is composed of two windings. The inner or primary is of heavy wire, one end of which is grounded and the other connected to one of the breaker points and to the condenser. The latter terminal should be well insulated and connections tight.

The outer winding, or secondary, is composed of many thousands of turns of very fine wire and carries the high voltage capable of jumping the spark plug gap. The cover of the coil on spark plug wires must not

be worn or ruptured.

On motors in which a coil serves only one plug, one end of the coil is grounded. Corrosion, dirt or dampness on surfaces around connections to the secondary may cause spark to creep between them or to ground. To eliminate dampness, place coil in oven (not over 150° F) for about an hour.

**COIL TESTER**

We have had numerous requests for a tester for armature windings or coils, to be used in the average dealer's repair shop.

We can supply the Eiseman Tester (Figure 21) in the following types:

Part No.	Current	Cycles	Volts	Price
275549	A.C.	60	115	On application
275550	A.C.	60	230	On application
275551	A.C.	50	115	On application
275552	A.C.	50	125	On application
275553	A.C.	50	230	On application
275554	A.C.	50	240	On application
275555	A.C.	50	250	On application
275556	A.C.	25	110	On application
275557	A.C.	—	110	On application
275558	D.C.	—	220	On application

Send for leaflet describing this tester fully. In addition to the instruction sheet packed with tester,



Figure 21



there is also included exact specifications covering all Evinrude and Elto coils.

Please send all orders for this tester to us. When ordering specify type suitable to electric current used in your locality.

**TESTING THE COIL**

Disconnect the primary lead from the breaker, or separate the breaker points by a piece of paper. Attach one of the coil leads to the testing equipment and attach the other to the ground lead of the tester. Connect the ignition leads to the spark gap terminals. Spark produced by the coil should consistently jump 1/4", or the coil is faulty.

Check the tester frequently with new armature coils. A spark jumping the 1/4" gap should penetrate through .015" of paper card. Failure to do this indicates faulty coil insulation, a defective coil or condenser.

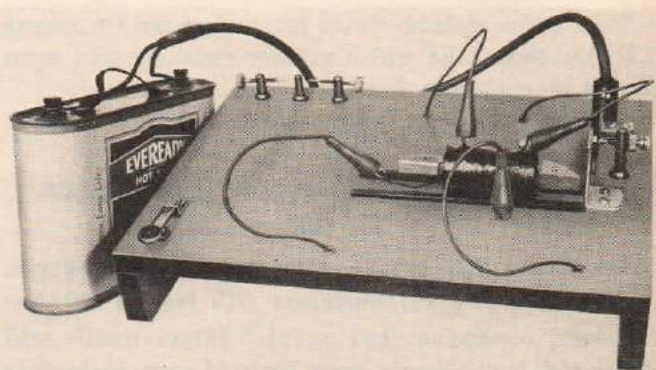

Figure 22

On armatures that have more than one coil, test one coil at a time.

The coil tester shown in Figure 22 can easily be rigged up by the service mechanic and will be found satisfactory for all practical purposes of coil testing in the average outboard motor shop.

**EVINRUDE-ELTO COIL WINDING SPECIFICATIONS WHEN USED WITH EISEMANN WINDING TESTER**

PART NO.	WHERE USED	TYPE	AMP.
MB1	Old Single—No. 1 Pump	Magneto	.9
MB2	Big Twin—DD Inboard—DDR Inboard	Magneto	1.5
MB4	Old Single—No. 1 Pump	Magneto	1.2
MB8	Evinrude "N"—"N. S." Sportwin—DD—DDR Inboard—DDV Pump—1928		
	"F" Fleetwin—R—RS Fastwin—1928 "H" Fastwin—T—TS Speeditwin	Magneto	1.9
208	1921-1922 Service Twin	Battery	2.4
17762	1926—62T Lockwood	Magneto	1.4
190108 (New #275370)	IN Folding Sportwin—No. 2 Pump—1929 "F" Fleetwin—1928 "H" Fastwin—1928 "U" Speeditwin—1929 "U" Speeditwin—6018-6019—601-602-604-618-619—634-635—6000-6001—6011-6012—6026-6027—6034-6035—420-421—418-419—450-451—145-146—904—142 Pump—4335-4336	Magneto	1.9
190189	162—403—Fold-Light	Magneto	2.3
190524	314-316—700-701—721-722—732-733—7013-7014—7004-7005	Battery	2.
190621	167-168—311—603-604—607-608—620-621—626-627	Electric	1.3
190622	315-317—702-703—734-735—7002-7003—7006-7007—7017-7018—7024-7025—7028-7029	Electric	1.1
190766	1928 to 31 Lockwood Ace	Magneto	1.65
190779	1928 to 31 Lockwood Chief	Magneto	1.4
190873	1927—72T Lockwood	Magneto	1.6
191049	4132500 to 4133999—4780000 to 4780499—4010000 to 4011499	Battery	2.
191050	Model 404 Fold-Light	Battery	2.6
191051	Model 361-363—605-606—624-625	Battery	2.
191073	900-901—914-915—924-925—9004-9005—9019-9021	Battery	2.2
191155	"C" Racing	Battery	2.3
191181	7022-7023—7026-7027—902-903—912-913—920-921—9000-9001—9026-9027—9031-9032—7031-7032—9035-to 9038	Magneto	1.5
191234 (New #275370)	407-408—409-410—442-443—454—4016-4017—4020-4021—4022-4023—4028—4092-4093-4094—4097-4098—4119—4122—4127—4148-4149—4151-4152-4153-4154-4155-4156-4157-4158-4159—4161-4162—4184—4209—4211-4212-4213—4216-4217—4221-4222-4223-4224-4225-4226-4227-4228-4229—4244—4258-4259—4261-4262—4267-4268-4269—4284—4287-4288-4289—4291-4292-4293-4294-4295—4303—4305—4307—4309—4313-4314—4332—4353 to 4358	Magneto	1.9



**EVINRUDE-ELTO COIL WINDING SPECIFICATIONS  
WHEN USED WITH EISEMANN WINDING TESTER**

PART NO.	WHERE USED	TYPE	AMP.
191272 (New #193008)	Model 905 Special Speedster.....	Battery	2.4
191322	Model 310 1400 and up.....	Battery	2.4
191444	800-801—820-821.....	Battery	2.
191451	"460" Racing.....	Battery	2.3
191460	4011500 to 4011999—Model 411-412—428-429.....	Battery	2.1
191572	4012000 & up—4130000 to 4132499—413400 & up—4780500 & up 4240500 & up Models 411-412—428-429—424—4163-4164—4099—4101—4128—4024—4025-4026-4027—444-445—4018-4019—4095-4096—4121—4214-4215.....	Battery	2.1
191884 (New #191572)	To Motors 4240500; Model 422-423—456-457—424-425.....	Battery	2.1
192100	Model 360, Special Lightweight.....	Battery	2.
192385	436-437-438—466-467—4008-4009—4010-4011-4012-4013.....	Battery	2.1
192544	452-453—458-459—4036-4037—4040-4041—636-637—640-641—6002-6003—6006-6007—6013-6014—6021-6022—6028-6029—6036-6037.....	Electric	1.3
192546	922-923—926-927—9002-9003—9006-9007—9011-9012—9017-9018—9024-9025—9028-9029.....	Electric	1.2
192648	4000-4001-4002-4003-4004-4005—432-433.....	Magneto	1.9
192882	638-639.....	Battery	2.
192980	6004-6005—6023-6024.....	Battery	2.1
192981	1933 Senior Speedster 3103001 & up.....	Battery	2.2
192982	1933 Senior Speedster 3103201 & up.....	Battery	2.2
192999	1929 Folding Lightweight (Series 90000) also Model 309.....	Battery	2.4
193006	1928 Quad (series 70000).....	Battery	2.4
193008	1923-1924-1925-1926-1927-1928 Service Twin—1928-1929-1930 Speedster; also Model 340-348 Speedster—Model 310 Service Speedster to 310 1399—358-359.....	Battery	2.4
193030	1929 Quad (series 75000).....	Battery	2.4
193146 (New #275540)	4030-4031—4042-4043—4046-4047—4050-4051—4054-4055—4070-4071—4102-4103-4104-4105—4111-4112-4113-4114—4165-4166-4167-4168-4169—4171—4178-4179-4180-4181-4182-4183—4219—4231-4232-4233-4234-4235-4236-4237-4238-4239—4241-4242-4243—4245-4246-4247-4248-4249—4271-4272-4273-4274-4275-4276-4277-4278-4279—4281-4282-4283—932 Pump—4315 to 4327—4359 to 4363.....	Magneto	1.9
193163	4032-4033—4052-4053—4056-4057—4072-4073—4106-4107-4108-4109—4172-4173-4174-4175-4176-4177.....	Battery	1.3
193164	4044-4045—4048-4049—4115-4116-4117-4118—4185-4186-4187-4188-4189-4190	Battery	2.4
193274	Same as 193164.....	Battery	2.4
193859 (New #275019)	4091—4139—4145-4146-4147—4195—4201—4203—4205-4206-4207-4208—4252-4253-4254-4255-4256-4257—4265-4266—4285-4286—4334—4296 to 4299—4329—4301—4346 to 4349—4351-4352.....	Magneto	1.9
193965	"X" Racing 8001.....	Battery	2.3
194168	7008-7009—7015-7016—7022-7023—9008-9009—9015-9016—9022-9023.....	Magneto	1.5
195436	"C" Racing 6038-6042.....	Battery	2.
195911	Mate and Cub 1939 to 1941—4263-4264.....	Magneto	1.2
275019	4351—4265-4334—4266—4364-4365.....	Magneto	1.9
275370	4313—4328—4341—4353—4355—4357—4335—6039.....	Magneto	1.9
275540	4315 to 4327—4359 to 4363.....	Magneto	1.9

When testing Battery Ignition Coils having two leads for connection to Hot Shot Battery, it is necessary to hold or clamp both leads together.



## ARMATURE

### ADJUSTMENT FOR SPEED CONTROL LEVER FRICTION

Should the speed control lever become so loose that it will not remain in a set position, it can be tightened by drawing up clamp screw provided for this purpose on armature base (Figure 23). On some motors it will be necessary to remove motor hood.

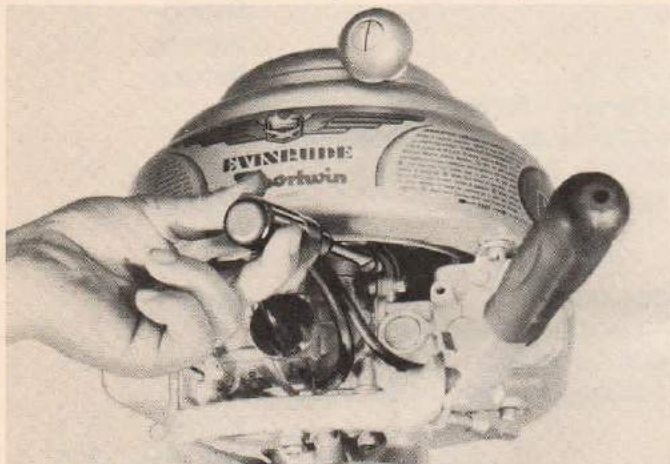

Figure 23

### STRAIGHTENING BENT ARMATURE PLATES

With the bent plate mounted on a turning arbor between the lathe centers, tap near the edge of the plate until it runs true. The newer type plates with heavy rim cannot become bent.

### TO REMOVE ARMATURE PLATE

Loosen clamping screw and lift plate off.

### INSTALLING ARMATURE PLATE

Do not clamp plate too tightly as this may cause strain on upper bearing, causing it to over-heat. Secure proper tension to hold speed lever in position by adjusting clamp screw. On smaller models, armature plate has a shim at bearing on crankcase. Be sure that this is properly replaced.

### INSTALLING WIRES AND TERMINALS

Use extreme care in soldering all magneto wires and terminals. Coils are easily ruined through carelessness in this important operation.

Always use soldering PASTE, or resin core solder, never an acid flux. Acid burns into vital parts, actually ruining them and necessitating costly replacements.

Be careful not to over-heat—use just enough heat to solder a permanent connection. Excessive heat easily burns vital parts. Make a neat job, without excess solder on the connection. Wipe away all excess soldering paste.

## SPARK PLUG EYELET FORMING TOOL

We are now in a position to offer you a special Eyelet Forming Tool (Figure 24) which will enable you to replace the special type spark plug terminals used with practically all of our motors.



Figure 24

Part No.

275384 Eyelet Forming Tool Assembly

120463 Eyelet Terminal—Inner

120464 Eyelet Terminal—Outer

Prices on application.

### OLD OR WORN WIRES

Never take a chance on making an old wire do the important job of delivering the spark. A good rule to follow is always to replace old wires with new when doing an armature overhaul job. Hidden flaws in old wires, insulation leakages, etc., can cause irksome troubles.

### WIRING

All wiring should be carefully inspected for possible loose connections, worn insulation or breaks which may occur inside insulation due to vibration.

The secondary leads (spark plug wires) carry extreme high voltage and may "leak" if insulation is cracked due to age. Such leaky wire should be replaced. Moisture on these wires may cause spark to creep from connections along the damp surface to ground.

### REMOVING FLYWHEELS

Never unnecessarily remove the magneto from a motor. The only reasons for doing so, except for complete overhaul, are for checking ignition points, con-



denser and coil, and for replacing the high tension wires. A heavy iron or steel bar or keeper (Figure 25) should always be kept across poles of the magneto while the flywheel is removed from the motor. When the flywheel is installed, the armature acts as a keeper.

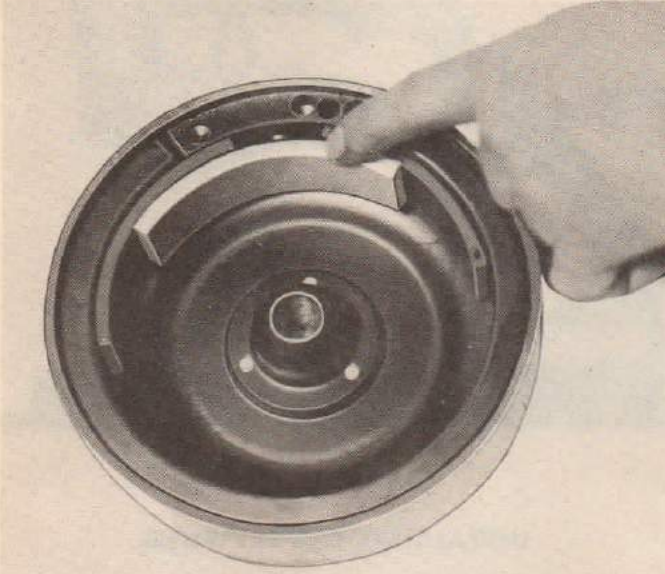

Figure 25

**HOW TO REMOVE FLYWHEEL**

On motors with enclosed flywheel, (except the Sportfour) the fuel tank must be removed before removing flywheel.

**SMALL AND MEDIUM SIZED MOTORS**

Holding the flywheel rigid, unscrew the flywheel nut until it rests against the starter plate, with enough tension to put an upward strain on the flywheel. The starter plate will now act as a wheel puller and care

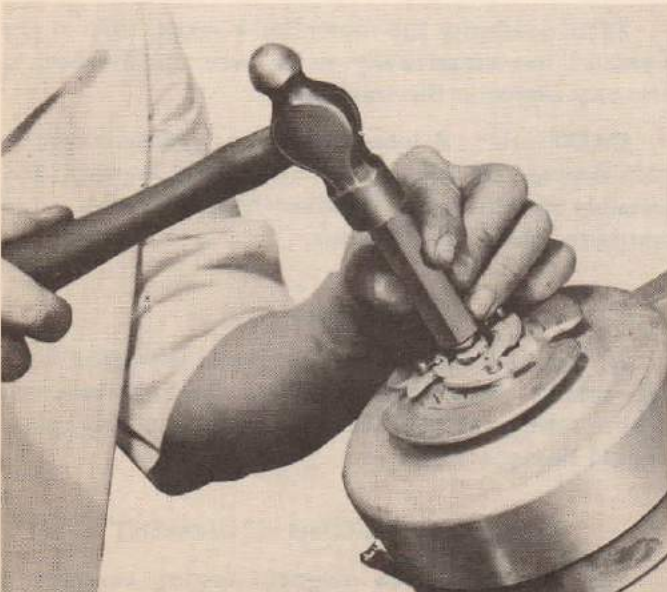

Figure 26

should be taken so that not too much strain is put on same when loosening flywheel nut. Too much strain may result in a broken starter plate. Tap flywheel nut a sharp blow with a light hammer using bar of brass or copper, (Figure 26). If flywheel does not come off, put a little more strain on starter plate by loosening nut a trifle more. If key is broken, puller must be used. When the flywheel comes off, use care not to lose the key by which the flywheel is held in engagement with the shaft. When replacing flywheel, draw up the nut as tightly as possible. Use a flywheel spanner hook wrench as illustrated (Figure 27) to insure good tightening.

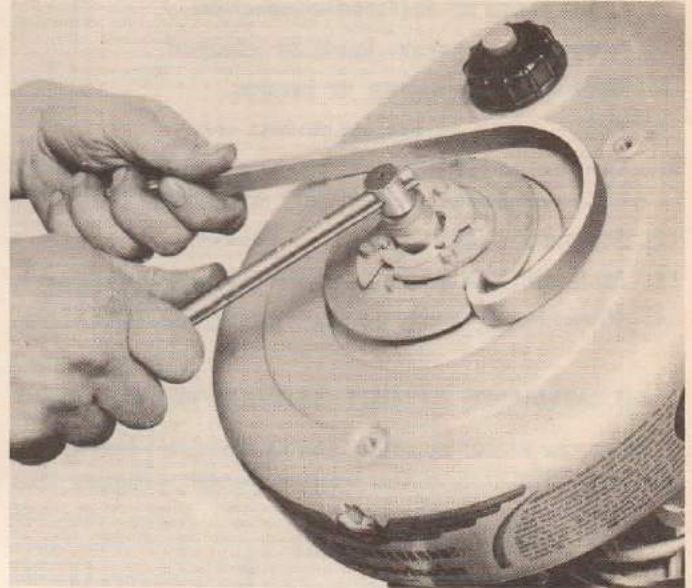

Figure 27

The tapers on large sized motors are usually very well fitted and consequently require the use of a flywheel puller to unseat the flywheel. A flywheel puller is an almost indispensable tool in a motor service shop. See illustration of puller (Figure 28) below, blueprints for which can be ordered from our service department.

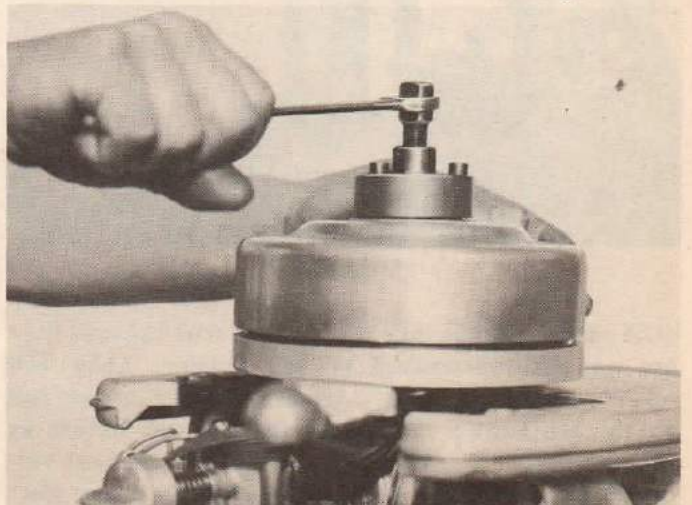

Figure 28



**MAGNETO CHECK CHART**

Below is a list of possible causes of magneto failure, use of which may be helpful:

1. Contact points — fouled, pitted, corroded or improperly adjusted. Correct adjustment: .020".
2. Contact points loose in mountings, or breaker point screw loose.
3. Breaker arm binding, slowing action.
4. Weak breaker spring.
5. Breaker arm tip — worn, loose or broken.
6. Breaker arm broken.
7. Cable loose at soldered connection.
8. Condenser — weak, loose or shorted.
9. Ground wire — loose or broken.
10. Coil — weak or broken down; wet.
11. Ignition leads — broken; faulty insulation. Check all connections; solder only with resin flux.
12. Magnets — weak, loose or broken.
13. Magneto pole pieces — loose (remote possibility).
14. Flywheel or armature plate bent to cause rubbing.

**ADJUSTMENT OF OUT-OF-TRUE FLYWHEELS**

Run the motor or rotate the flywheel at slow speed, marking the high point with a pencil. (Figure 29.)

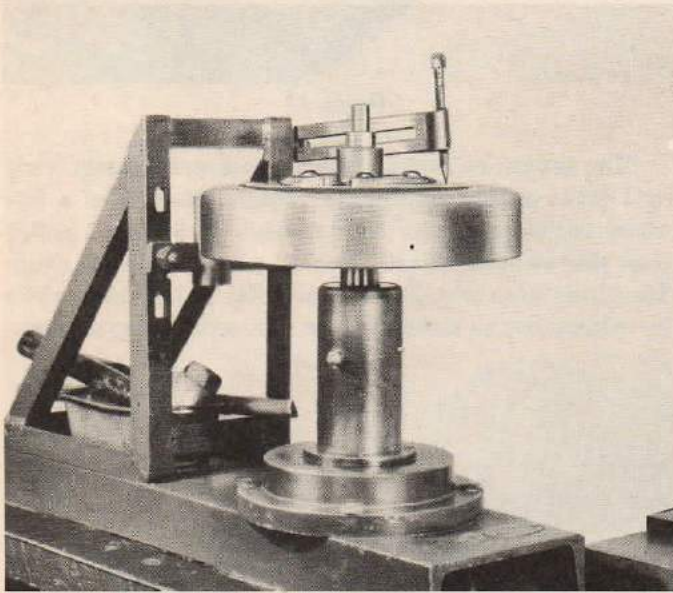

Figure 29

(Die cast flywheels may seem out of true because they are not finish-processed on the outside. They will operate satisfactorily so long as the poles do not rub on the armature.) Mount the flywheel on fixture as shown (Figure 30) or on a scrap crankshaft held vertically in a vise. Tap the high side with a heavy rawhide or wood mallet until flywheel runs true.

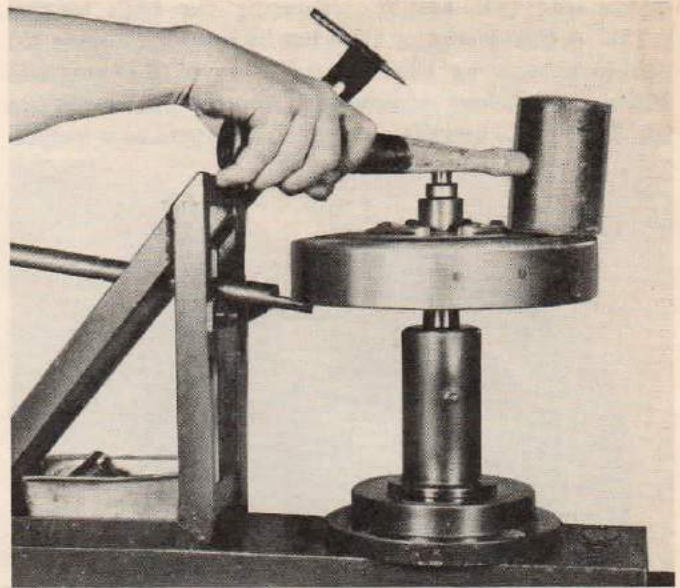

Figure 30

**INSTALLING THE FLYWHEEL**

After mounting armature plate, set key tightly in crankshaft keyway, making sure these remain in position until flywheel is seated on crankshaft taper. Also be sure that key and keyway line up before drawing up on flywheel nut. Draw flywheel nut up as tightly as possible to prevent its becoming loose during operation. Be sure key is not too high in keyway.

To check whether flywheel key is not too high in crankshaft keyway, place flywheel in position on crankshaft with the armature removed. Hold a sheet of white paper under flywheel at hub in line with keyway. Look down through keyway from the top. If paper is visible, key is in proper position, enabling flywheel to seat firmly on crankshaft taper.

After operating the motor for a while, tighten the flywheel nut occasionally to be sure the flywheel is securely seated in the crankshaft.

**CAUTION:** A loose flywheel can cause considerable damage by ruining the crankshaft keyway, and possibly fracturing the flywheel hub. This may cause continued shear pin breakage.

**Tapers**

If flywheel tapers on larger motors with steel hubs are shabby, the burrs should be carefully removed with a scraper or file. If damaged too seriously, parts should be replaced.

**MAGNETO TESTING EQUIPMENT**

For information on magneto testing equipment, write our Service Department.



**SECTION XII**

**THE FUEL SYSTEM**

Fuel flows by gravity from the fuel tank to the carburetor which is equipped with a strainer.

**REMOVAL OF FUEL TANK**

Always use wrenches on cap screws when removing the fuel tank. On hooded motors, hood must first be removed before tank fastenings are accessible.

**FUEL LINE**

Always use a wrench (never pliers) on compression fuel line nuts. Compression sleeves should not be taken from an old line and used over again; use new sleeve or leakage may result. Be sure that compression nut starts to turn on easily with fingers to avoid cross threading.

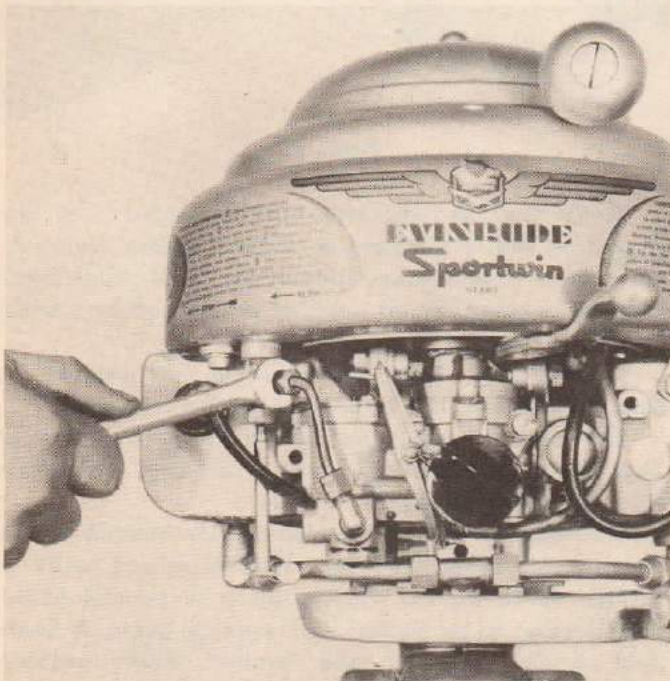

Figure 31

**AIR LOCKS IN FUEL LINE**

Air locks usually are caused by operating the motor until all fuel is exhausted from the fuel tank. After replenishment, a bubble of air becomes locked in the fuel line. To remedy, remove fuel line at carburetor, replace when fuel flows.

**CLEANING FUEL TANK**

Flushing with clear gasoline is the best way to clean the fuel tank. Flush out tank and parts thoroughly, also clean carburetor screen and fuel line and fittings.

**REMOVING DENTS FROM TANKS**

Drain dented tank thoroughly, flush out with water and mount on a fixture, as shown in Figure 32. Attach air pressure hose to tank outlet. Put filler cap in place securely.

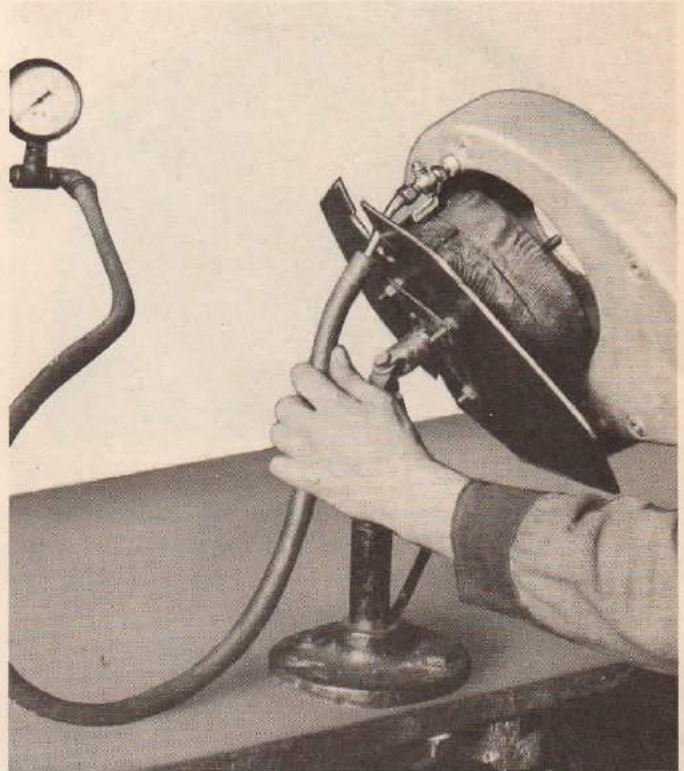

Figure 32

Apply approximately 11 pounds (never over 15) air pressure. Play flame around outside outline of dent, working toward its center but keeping most of the heat directed toward outside of dent. This should

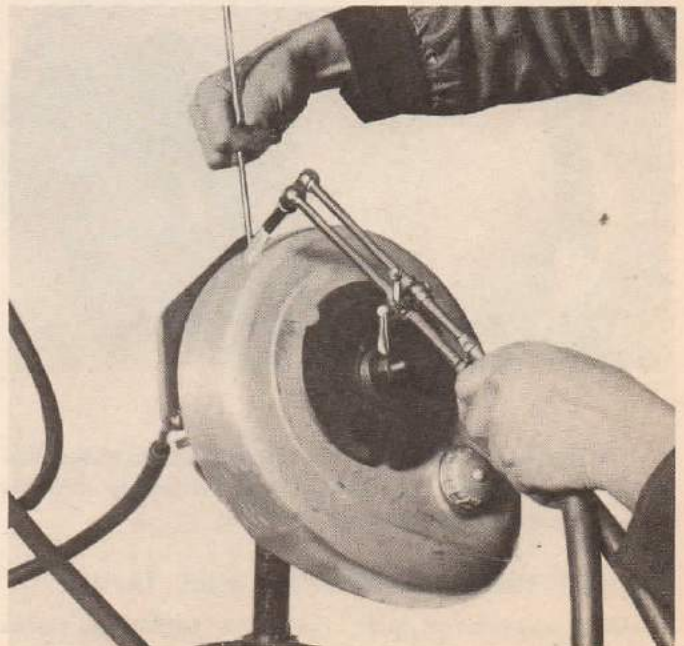

Figure 33



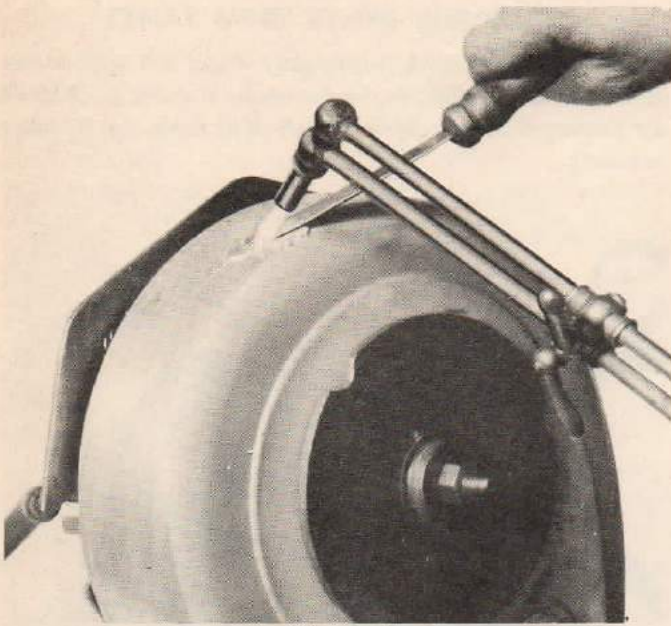

Figure 34

remove the dent almost entirely. Experienced repairmen tap bulges slightly with a flat board to attain maximum results, but care must be taken with this operation not to put in more dents.

If remainder of dent is now to be removed, fill the cavity with aluminum solder and file down until smooth.

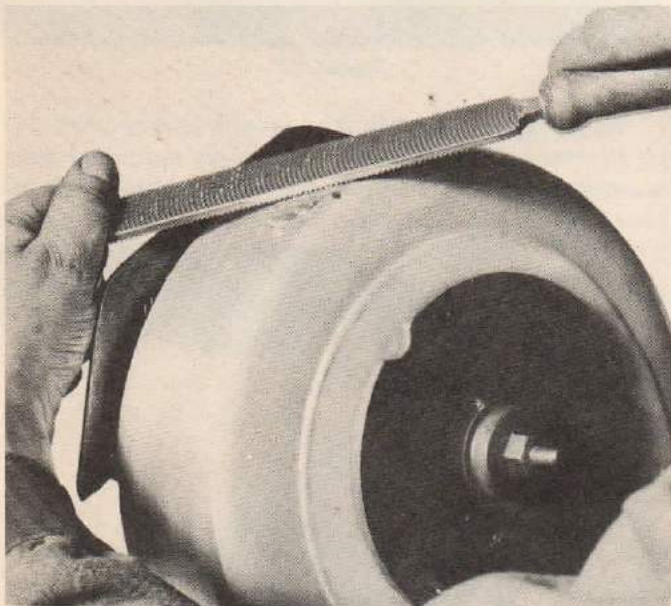

Figure 35

On square shaped tanks soldering on exposed flat surfaces should be avoided as it is extremely difficult to accomplish a smooth job on these.

#### CUTTING AND WELDING FUEL TANKS

With experience, badly dented or perforated tanks can be restored by welding. However, the inexperi-

enced welder should "practice up" on old tanks before attempting such extensive repairs.

In the case of a dent too deep to respond to the air pressure method, a neat hole later to be welded should be cut into the opposite wall, making it possible to pound out the dent with a wood block.

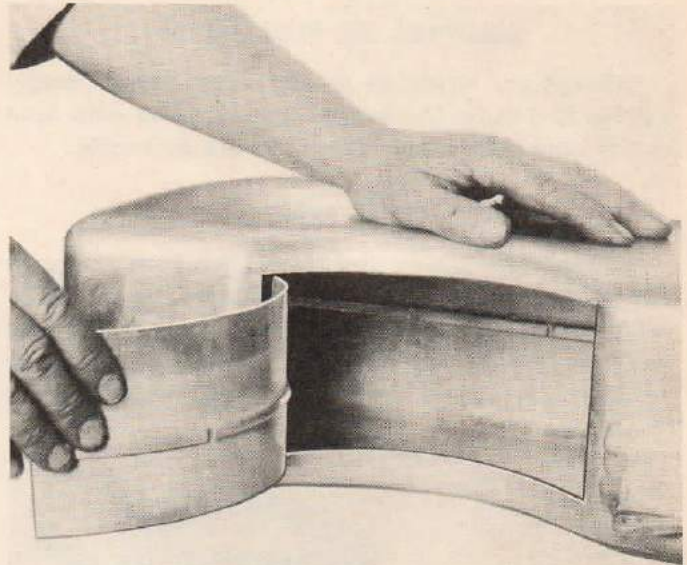

Figure 36

If the tank is punctured with a ragged hole, this should be neatly trimmed to about 2 inches diameter, and a piece of aluminum alloy of the same gauge fitted into the opening. Small holes or cracks can be welded up without cutting and patching.

**CAUTION:** Before undertaking any welding, be sure that all fuel has been removed from the tank.

For welding obtain the following supplies: Oxweld Sheet Aluminum Flux;  $\frac{1}{8}$ " Oxweld Sheet Aluminum Rod; Acetylene torch.

Thoroughly clean all surfaces to be welded with a wire scratch brush. Mix flux with water and apply to surface to be welded. Adjust torch to neutral flame. Heat section to be welded with moving flame. A flame held steady may melt tank through. Apply welding rod, flowing it on to injured portion, and fluxing it to tank metal. Do not pile up melted aluminum rod on tank.

Immediately after welding and before tank cools, clean off excess flux with water. If flux is allowed to cool on tank, cracks will appear near point of weld.

#### WELDING OTHER MOTOR PARTS

With a few exceptions such as cylinder flanges, crank cases and gear housings, motor parts can seldom be successfully welded, and should preferably be replaced with new parts. For reasons of safety we particularly warn against the danger of welding rotating parts such as connecting rods, crankshafts and flywheels.



### TO APPLY TRANSFER-DECALCOMANIA TO FUEL TANK

Here is the proper method for attaching new transfers to the gasoline tank:

1. Clean tank thoroughly, using gasoline if necessary. Allow tank to dry, then wipe with a clean cloth.
2. Apply coating of Evinrude transfer cement.
3. Allow to dry for about 3 minutes or until cement becomes tacky.
4. Soak transfer in warm water for about 30 seconds or until white paper backing can be slid off easily.
5. Place in position and roll down with soft rubber roller.
6. Wash transfer with wet rag or sponge.

If above instructions are followed carefully, it is not necessary to varnish transfer as it will adhere to gas tank firmly.

As a business and good will builder, we recommend that all tarnished or ragged transfers be replaced on motors that come to you for service. Your customer will be pleased, and the impression on others who see the motor will be to your credit.

Transfers for practically all of our motors are still available and can be obtained at low cost.

## SECTION XIII CYLINDERS

The most common faults found with cylinders are these: Worn at ports, cracked from freezing, corrosion, warped from over-heating, scored.

When a cylinder is suspected of being worn over-size or out of round, check the bore with an inside micrometer. Excessive wear usually occurs at port bridges. Wear of approximately .004" to .006" causes ring breakage. Such cylinders will provide added service after careful reboring or re honing. Cylinders worn .010" or more should be replaced.

Water in the cylinder usually comes from a crack occasioned by freezing when the motor was stored for the winter with undrained water in the cylinder jacket or from tilting the motor before water has drained out. Occasionally cylinder wear will expose a flaw not discernable when the part was new. Motors with such flaws should be replaced.

Warpage, while rare, is usually found in cast iron cylinders, in which cast iron pistons are run. Badly warped cylinders should be replaced with new.

Scoring usually occurs from over-heating, water entering cylinders during operation, or from a foreign object such as a broken ring fragment wedging between the cylinder wall and the piston. Minor scores sometimes do not affect operation. Badly scored cylinders should be replaced.

### WATER JACKETS

Expansion plugs can be removed and salt and oxidized metal can be removed with wire probe. After an opening is made, flush with fresh water.

### CHROMIUM PLATING CYLINDERS

Occasional requests are made by owners, usually race drivers, for chroming iron cylinder bores. We do no chroming of cylinders here at the plant, but at times accommodate customers by sending outside for such work. In favor of this operation it is claimed that greater perfection in the surface of the bore is obtainable, that the surface wears longer, that old cylinders have entire absence of metal strains and consequently will not warp, also that the ring port bridges are and remain more perfectly aligned for piston ring travel. Due to greater hardness, the chromium surface will wear longer than the iron.

If you are interested in chromium plating cylinders, write our Service Department for complete information.

### CYLINDER GASKETS AND GASKET MATERIAL

For the best operation be sure that cylinder gaskets are always perfect, free from leaks and of recommended material and thickness. Handle gaskets carefully as they tear easily. In making repairs it is usually best to replace used gaskets with new. If gaskets are not damaged when taken off but are dry and have shrunk, put in a pan of water; water will soften them up.

### SELF-FORMING GASKETS

For several models we now use self-forming gasket material which can be purchased in cans. We recommend Permatex Form-A-Gasket No. 1, which dries quickly and sets firmly. It is leak-proof to gasoline, oil, grease and water and withstands high pressure and

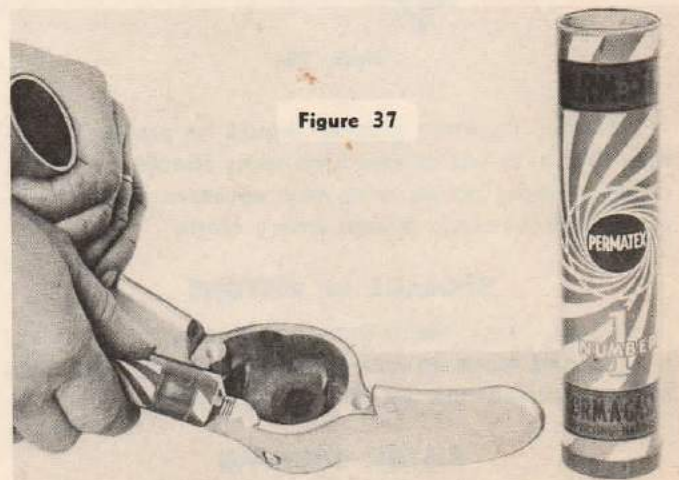

Figure 37

vibrations, by cementing the two surfaces into a practically solid joint.



## SECTION XIV

### PISTON AND RINGS

Perhaps no other part of an outboard motor is so vital to its efficient operation as the piston. Great sums have been spent in the development of high grade piston materials and designs and methods of machining them perfectly. In all overhaul jobs, the piston and its rings are deserving of the most careful attention.

If the motor operates efficiently, starts easily and has plenty of pep, the piston(s) is probably in good condition. When lack of compression causes hard starting and a reduction in speed, look to the piston for the source of the trouble.

#### CHECKING THE PISTONS

A great deal can often be discovered by carefully examining the piston. If it has uniformity of color, indicating uniform contact with the cylinder and lack of "blow-by," the piston is probably doing a good job. However, it is well to check for wear with a micrometer.

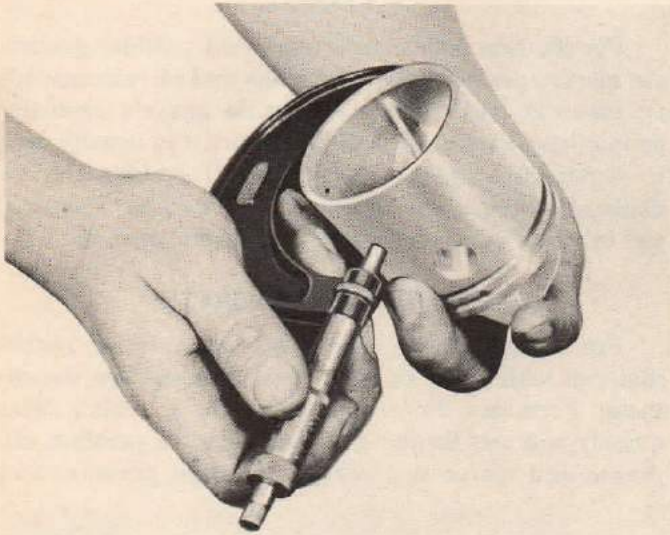

Figure 38

Warped or worn pistons should be replaced. Pistons that have one or two high spots should be rubbed down at these points with mild abrasive, such as oil-stone, pumice-stone or fine emery cloth.

#### STORAGE OF PISTONS

Always stand the pistons which you have in your repair parts stock on end. Pistons layed on their sides for long periods are apt to "out-of-round."

#### PISTON BURNING

Burning the heads of aluminum alloy pistons comes from any of the following:

1. Over-advancing timer lever causing pre-ignition.
2. Using "doctored" fuels containing chemicals which create excessive heat. Service models should be run only on ordinary gasoline containing the proper proportion of lubricating oil. (See instruction Pages 14, 15.)
3. Increasing compression by changing cylinder dimensions.
4. Friction caused by presences of dirt or metal particles which enter through the carburetor or arise from friction in a bearing or other motor part.
5. Use of wrong type spark plug, or loose spark plug in cylinder. Use only the ones recommended. (See table, Page 85.)
6. "Starving" the motor by running with too lean a mixture of fuel will create excessive heat, especially in larger motors run at high speeds. Too rich a mixture can also cause burning.
7. Excessive engine speeds due to use of undersize or underpitch propeller.
8. Sloppy piston fit, preventing heat from dissipating away from piston. (See Piston Clearance Chart, Page 64.)

#### PISTON CLEARANCES

A good, general formula for piston clearances on service models is as follows:

Iron Pistons:—.001" for every inch of diameter. (For example, on a motor with 2½" bore, use .0025" clearance.)

For aluminum alloy pistons the clearance should be not less than .002" for each inch of diameter.

For racing motors the clearances are higher. (See chart of piston clearances, page 64.)

#### PISTON RINGS

It is the function of the piston rings to provide good compression in the cylinders so that the motor will start easily, and run easily and efficiently, particularly at slow speeds. The piston and cylinder fit also contribute to compression, but the rings and ring grooves are most important. The rings should contact the cylinder walls evenly and should also fit snugly into the ring grooves to hold compression from blowing by.

#### FITTING OF PISTON RINGS

In fitting new rings to a piston, care must be taken to see that the grooves in the piston are clean, and all carbon deposit has been removed from the grooves. Be careful not to damage ring grooves of piston when removing carbon.

In cleaning piston ring grooves preparatory to installing new rings, break an old ring from identical



piston. Grind a square end on a piece of about a third of the broken ring. Use this as a tool with which to remove carbon from groove.

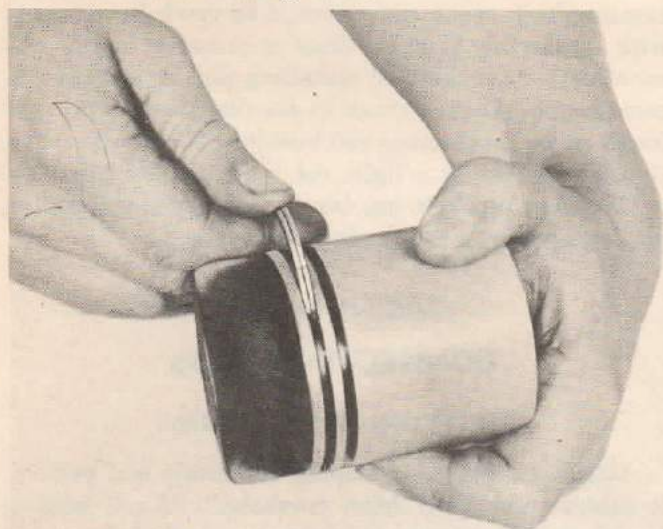

Figure 39

Before installing new rings the gap between the ends of the rings should be checked. This is done by placing the rings squarely into the cylinder in which it is to operate, and checking the gap between the ends with feelers.

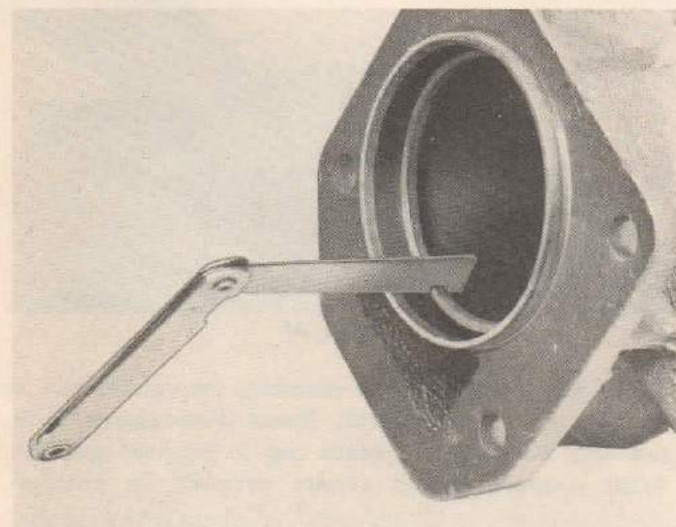

Figure 40

The proper gap between the ends of the piston rings is from .003" to .006" depending on the diameter of the ring.

If the gap is too small, the ends of the rings should be filed until the correct gap has been obtained.

Next, roll the ring around in the groove of the piston to which it is to be fitted. The ring should roll freely in the groove, which it will do with about .0005" clearance. (Figure 41.)

If the ring fits too tightly in the groove, it should be lapped in. (Figure 42.)

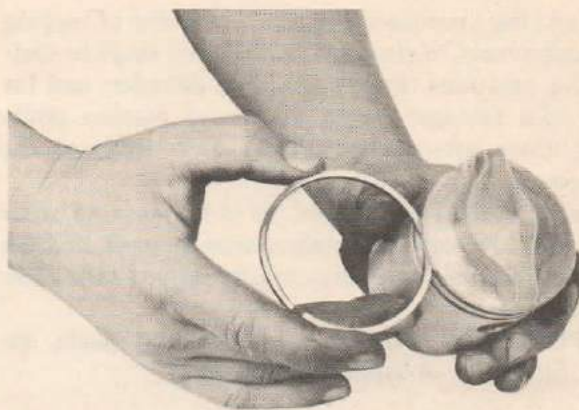

Figure 41

Care must be taken when installing rings not to break them, or unduly expand them, and in the case of Lynite pistons, do not cut the side of the piston wall.

### LAPPING PISTON RINGS AND RING GROOVES

Proper fit of the ring in the ring grooves is obtained by lapping. For this the following equipment is necessary:

1. Piece of plate glass 8" square or larger.
2. Lapping Block—Glue to one face of a flat piece of wood about 4" square a surface of felt. To the center of the one side attach a hand knob.
3. A quantity of 00 emery cloth.
4. Powdered Bon-Ami.

To lap, place a surface of emery cloth flat on the plate glass. (Emery Compound No. 1 can also be used on plate glass.) Place the ring on the emery cloth, and place the felt side of the block on the ring. Grasping knob, bear down gently, sliding the ring in a figure 8 motion. Examine the ring occasionally to see that only enough of the surface is removed to insure perfect flatness. Low spots will show dark; only lap until entire surface shows bright. Lap other side of ring in same manner.

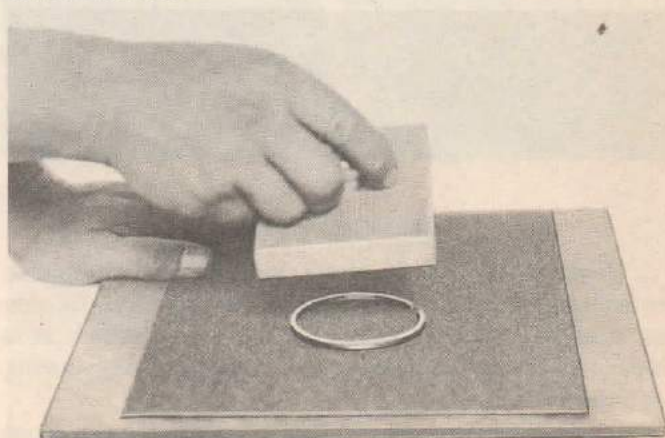

Figure 42



To lap ring grooves apply small quantity of lapping compound evenly to ring grooves. Install rings in their respective positions. Insert piston in cylinder, and for one or two minutes apply a turning motion while pushing them alternately against both sides of the ring grooves.

When the rings are pinned, as is the case on some models, this method of lapping cannot be used, and the ring must then be fitted as carefully as possible without this operation.

**IMPORTANT:** Clean thoroughly all parts, removing all traces of lapping compound.

### INSTALLING PISTON PIN

All aluminum alloy pistons are reamed at the factory for a heat fit of the piston pins.

#### PISTON PINS

Piston pins should fit snugly in the pistons; freely on the connecting rod. On the smaller size motors pins may have to be tapped into the piston after soaking it in hot water. Install spring rings. If spring ring fits loose in groove, stretch it out to greater tension or replace with new spring rings.

#### REAMING PISTON PIN HOLE

On new piston, when piston pin hole does not permit entrance of piston pin, ream piston pin hole to micrometer size of piston pin to secure ideal fit.

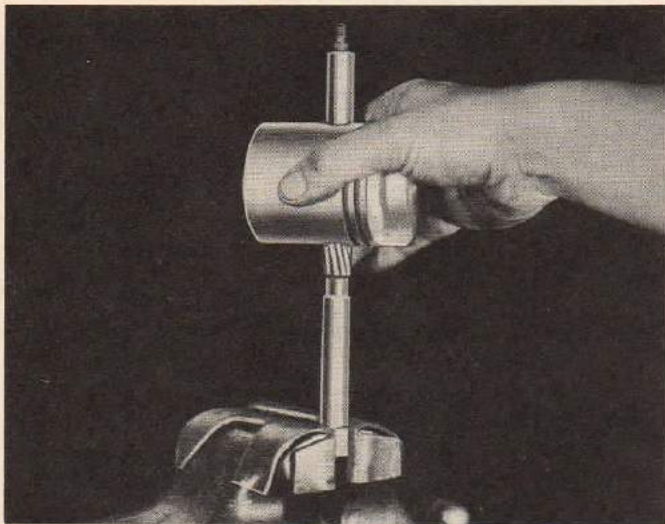

Figure 43

#### LOCKED TYPES

When installing the piston pin, pre-heat the piston in boiling water and drive the pin into position. Be sure to lock it securely with the means provided as a loosened piston pin can create much damage during operation.

Iron pistons are reamed in production for slip fit on one side and drive fit on the other. Press pin through

the slip fit hole (which is the one without the locking provision) into position.

Should the piston metal burr around the holes, creating high spots, these should be carefully removed with a bearing scraper. Also micrometer piston for roundness, as process of installing pin sometimes distorts piston. Always check to see that piston pin turns freely in the connecting rod bushing. When necessary, re-ream by taking a light cut until pin fits properly.

If piston pin hole has become damaged by driving in piston pin, remove burrs with a scraper.

## SECTION XV CONNECTING RODS

### REFITTING BRONZE RODS

Check for wear by grasping rod firmly and pushing it against and away from crankshaft. If rod bearing has worn excessively (see clearance chart, page 63) refit as follows:

Remove rod from shaft. Rub joint surface of rod cap gently on flat surface of fine emery cloth. (Figure 44.) Remove only material so that rod will fit snugly enough to shaft to cling slightly when rod is installed.

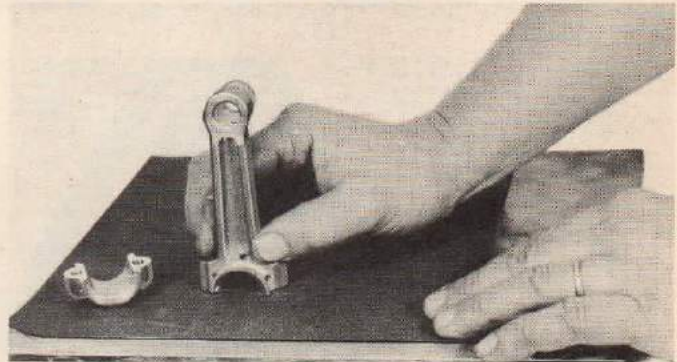

Figure 44

To avoid necessity of re-reaming, be careful not to remove too much material. Ream if necessary. (Figure 45.) Be sure to replace cap in original position. With connecting rod screws securely in position,

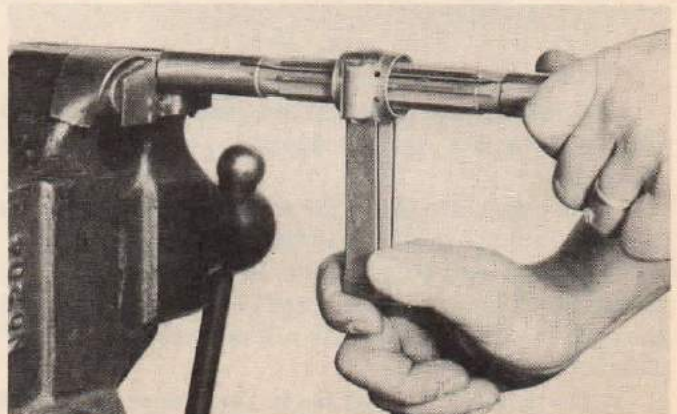

Figure 45



hold rod with crankshaft hanging down. Strike rod gently with small hammer around the crank pin until it is free from binding at any point. Rods should fit closely but should never be tight.

Check screws to make sure they are really tight, and wire them where there are holes drilled in screws for wiring. Have wire hug rod closely or it may rub during operation. If not drilled for wire, upset metal on rod at slot in screw to hold screw in position.

### STRAIGHTENING STEEL OR BRONZE RODS

Install rod securely in fixture, and use small tee-square or gauge as shown to determine extent of misalignment. (Figure 46.) Use lining-up bars to straighten rod. (Figure 47.) Recheck until rod is perfectly straight.

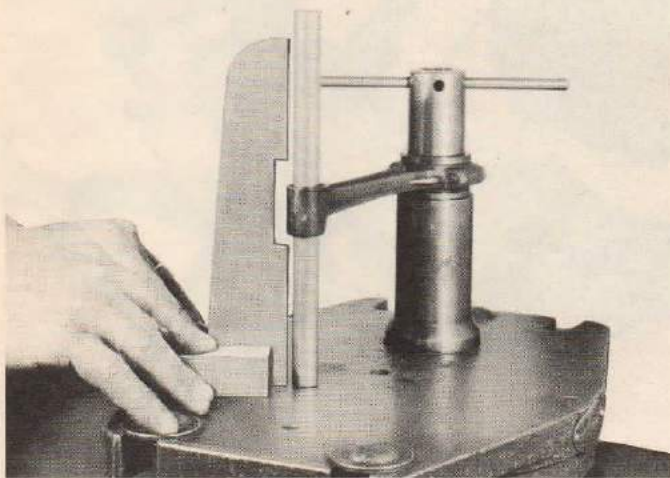

Figure 46

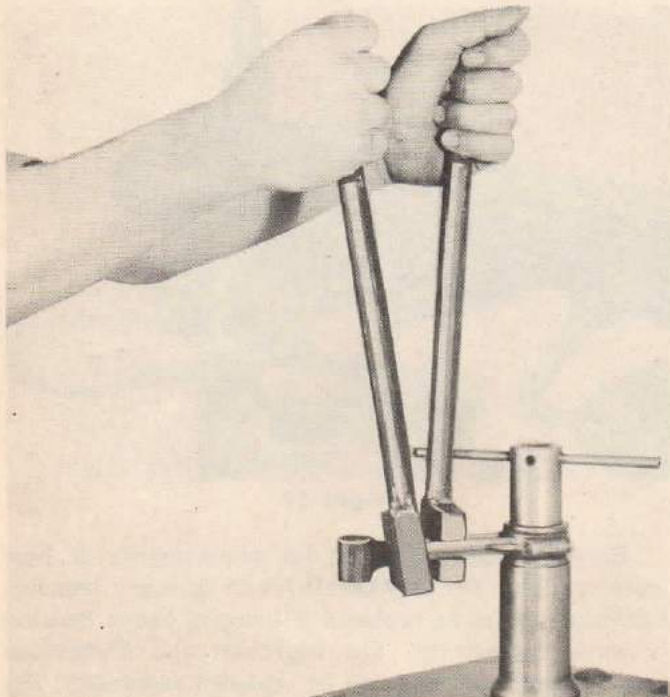

Figure 47

### CLEARANCES OF BRONZE OR ALUMINUM CONNECTING RODS

In fitting bronze or aluminum connecting rods to crankshaft pins, the approximate clearance on motors with exception of Lightfour, should be approximately .002". On Lightfour models this clearance should be .0025". These clearances will allow the rod to drop when placed in an upward position on crank pin.

### CORRECT POSITION OF PISTON

Always see that the piston is installed with the short side of the deflector toward the intake of the cylinder, as shown.



Figure 48

### ROLLER BEARING CONNECTING RODS

When disassembling power head parts of motors equipped with roller bearing connecting rods, care must be taken to keep the roller bearing of each rod together with the rod. The best way to accomplish this is to place the bearing parts in a small sack and tie the sack to the connecting rod, tagging the rod No. 1, 2, 3, or 4, as the case may be.

This is necessary because the bearings are fitted individually to each crankshaft pin.

For replacement, we can furnish rollers undersize or oversize, in graduations of .0001 up to .001.

### SPEEDITWIN

In this model, 6-piece steel retainers hold the bearing rollers in position. After thorough cleaning and stone-removing all burrs, reassemble by laying three retainers with rollers into the connecting rod bearing. Bring up into position on crank pins. Douse with heavy oil to keep rollers in position. Place remaining retainers and rollers in position on crank pins. Put cap on in proper matched position. Install connecting rod screws, bringing pressure down evenly on both screws.

Try rod for fit of roller bearing by lifting rod up and down. There should be just clearance enough to permit free motion. If too sloppy, larger rollers should be installed. Most wear occurs in rollers and connecting rods, although crank pins also wear to some extent.



SECTION XVI

CRANKSHAFT

STRAIGHTENING THE CRANKSHAFT

Crankshafts that are not bent too badly can be straightened in the following manner:

Place the shaft on an accurate V block and by rotating it slowly against a dial indicator, discover the high side.

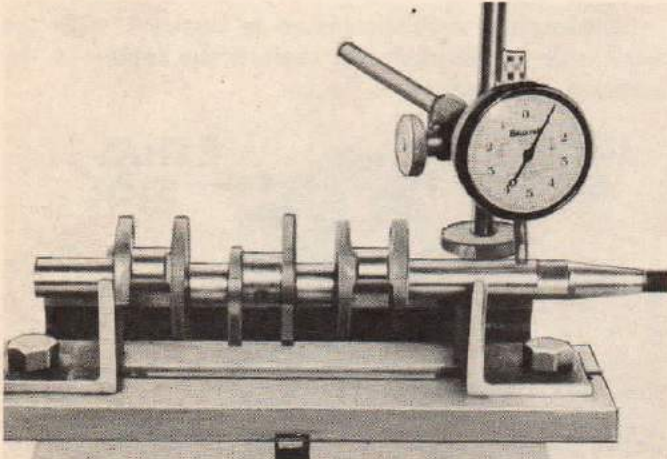

Figure 49

If no V block is available, clean the centers in the ends of the shaft, also removing any burrs. Firmly insert the shaft between centers of a lathe. Do not exert too much pressure as this will spring the shaft. Using a dial indicator, check the shaft for alignment.

When the high side has been located, place shaft in V blocks in arbor press and apply pressure at proper point until shaft is true. If no arbor press is obtainable, a lead hammer may be used. (See pages 67, 68, Table of Limits.)

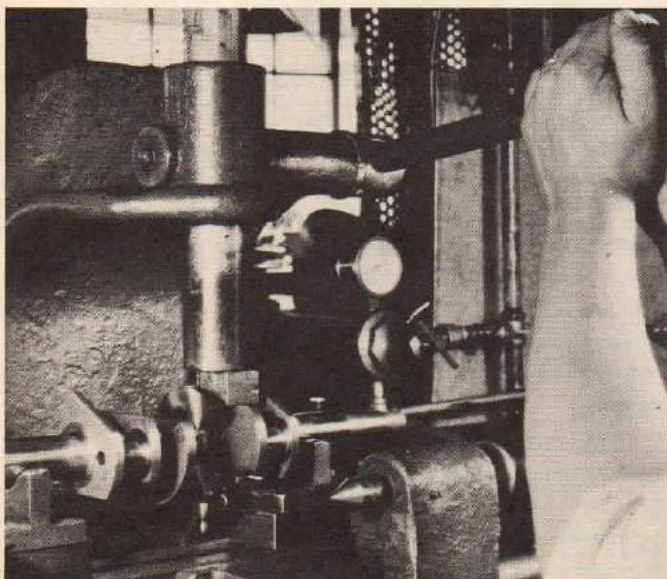

Figure 50

CRANK CASE

**MATE AND CUB**—To disassemble, remove four screws holding cylinder and remove cylinder. Remove two connecting rod screws. Remove four screws holding lower bearing and remove bearing. Crankshaft can now be removed. Wash all parts.

**PAL, RANGER, ACE, SPORTSMAN, HANDI-TWIN, SPORTWIN, LIGHTWIN, FISHERMAN**—To disassemble, remove four screws holding cylinder and remove cylinder. Remove two connecting rod screws. Remove four screws holding lower bearing and remove bearing. Crankshaft can now be removed. (Figures 51, 52, 53, 54.) Remove carburetor. Wash all parts.

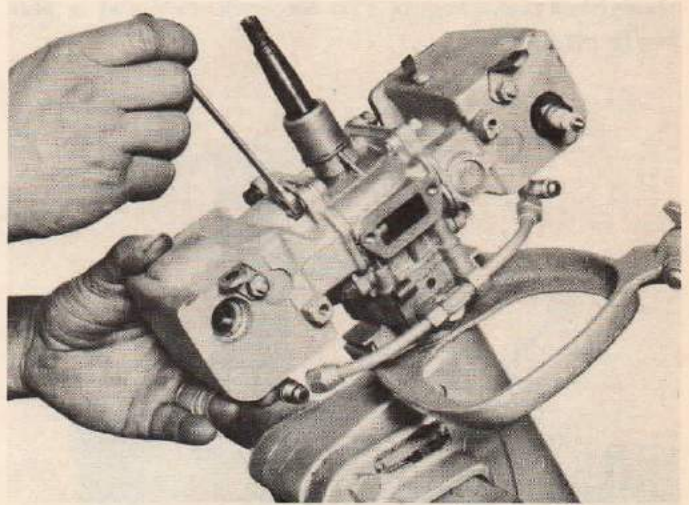

Figure 51

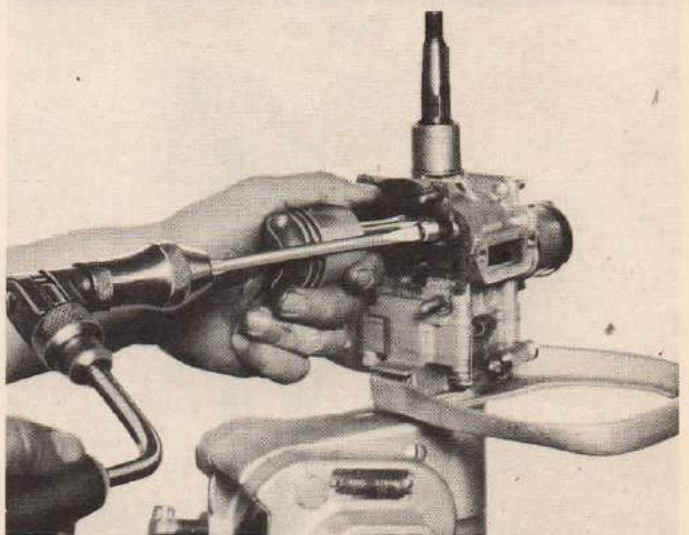

Figure 52

Examine upper bearing for score marks or heat discoloration. Try crankshaft for fit in upper bearing. Crankcase must be replaced if integral upper bearing is worn excessively. On Lightwin and Fisherman models, upper bearing can be replaced separately. See table of Bearing Clearances on page 63.



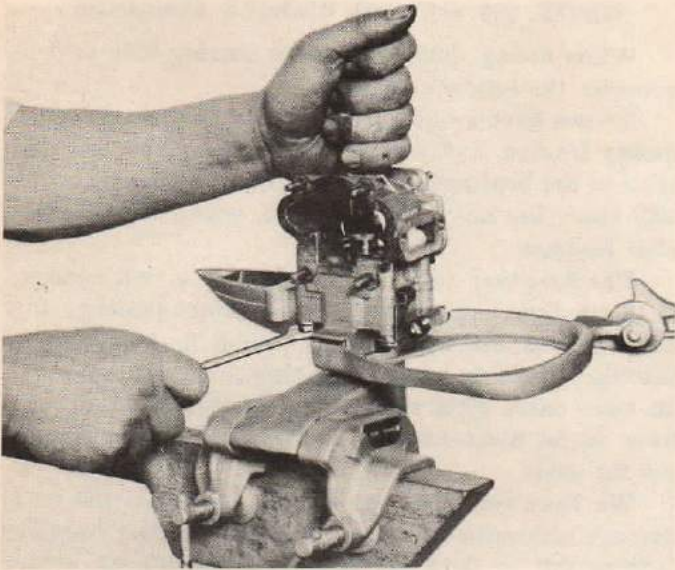

Figure 53

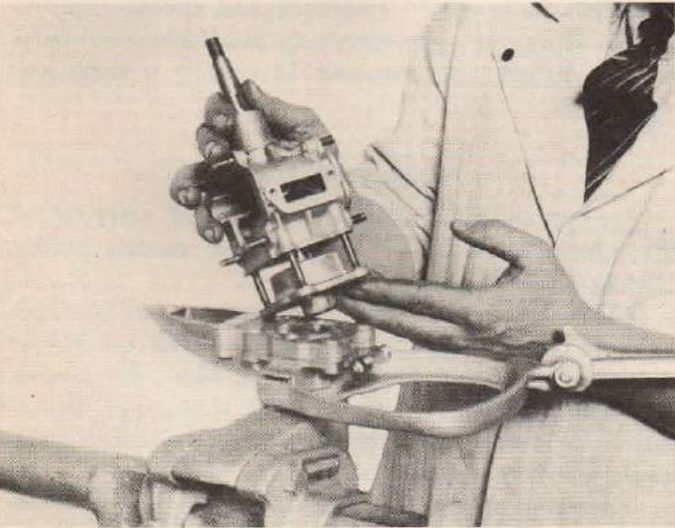

Figure 54

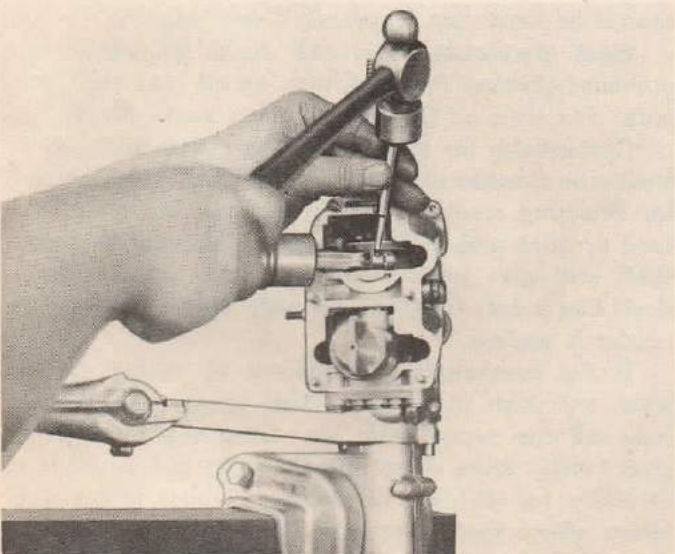

Figure 55

In reassembling, use a few drops of oil on crankshaft. Replace gasket with new one.

ZEPHYR—The crankshaft disassembling procedure is like that for the Pal, etc., outlined directly above. When you come to the connecting rods, mark these for positions with a center punch, (Figure 55) (tap lightly) or a file. Also mark the pistons with a center punch.

Remove the four lower bearing screws and remove bearing.

Remove dowel pin by inserting  $\frac{1}{4}$ "-20 machine screw to be used as a puller. Also remove the two screws holding center bearing in back of crankcase. Apply blow torch to outside of crankcase while driving out crankshaft with rawhide, wood, or lead mallet. Take care that flywheel key is in passing position; if not, carefully first remove key.

Check upper bearing as outlined above and replace crankcase if bearing is worn excessively.

Examine center bearing and crankcase for excessive wear, scoring or breakage. Replace crankcase and bearing if necessary. See "Bearings," page 44. See that all parts are free from burrs, grit, etc.

In reassembling, first install crankshaft and center bearing, (also applying heat to crankcase) tapping this gently into position while making sure that dowel pin hole lines up with hole in crankcase. Insert dowel pin, tap into place as shown, and insert two screws that

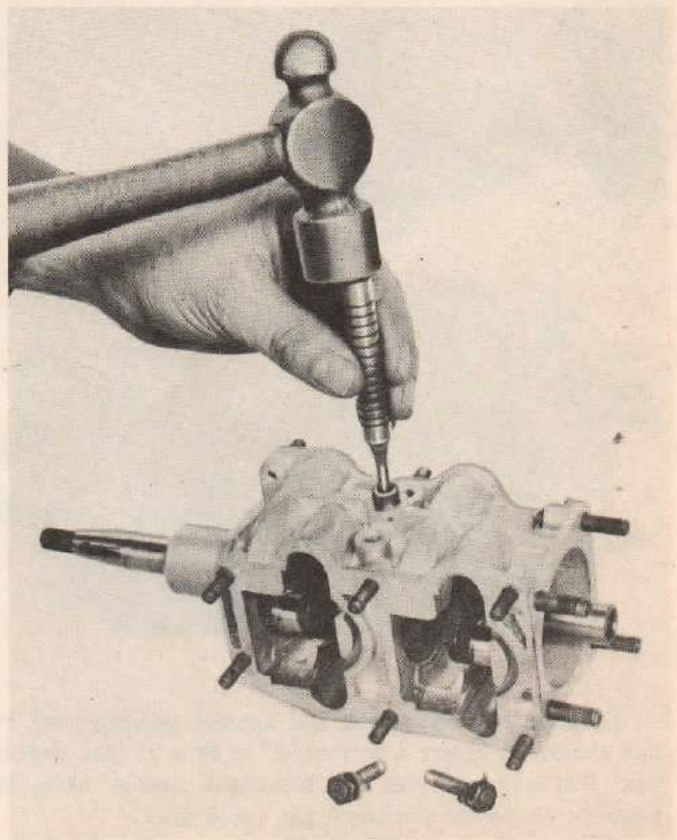

Figure 56



hold center bearing. Bring screws up snug, but do not force them too tight as center bearing may thereby be pulled out of line.

Install lower bearing, using new gasket of proper thickness. A choice of four thicknesses of gaskets is available. Turn crankshaft with fingers while pulling up and down to see if it turns freely, is in proper alignment and has about .003" end play. If it appears to be too tight, tap crankshaft with mallet to free and locate center bearing in its proper position. If still tight, some foreign obstruction may be interfering and if necessary parts should again be disassembled, checked and cleaned thoroughly. Remove all burrs.

Re-install connecting rods and pistons, cylinders, carburetor as above outlined under Pal, etc. models.

**LIGHTFOUR and SPORTFOUR**—Proceed exactly as outlined above for the Zephyr. Unlike the Zephyr, the upper bearing on the Lightfour and the Sportfour is replaceable separately. To remove this bearing from the crankcase, press it out on an arbor press. See "Bearings," Page 44.

**SPEEDIFOUR**—The procedure is exactly as outlined for the Lightfour except for the center bearing. This bearing on the Speedifour is held in place by one large and four small dowel pins which are hollow and threaded on the inside. These are removed by inserting threaded tool (see Figure 57) in pins and pulling them out.

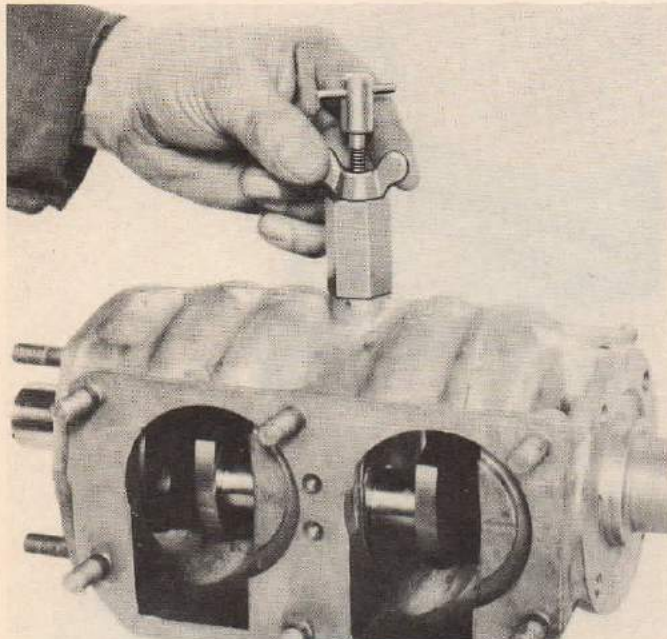

Figure 57

In emergencies, when the special pulling tool is not available, insert a screw,  $\frac{1}{4}$ " x 20 x 2" into dowel pin. Put screw in vise and tap crank case as close as possible to dowel pin until pin pulls out.

Reassembly procedure is like that outlined for the Lightfour, with exception of the center bearing dowels.

## HINTS ON FITTING BRONZE BEARINGS

When fitting shafts to bronze bearing it is well to consider the following points:

Do not have a tight or binding fit or this will cause undue friction and permit the shaft to run hot and stick in the bearings. Neither have a sloppy fit as this will allow too much chance of oil, grease or compression leakage.

The best way to fit an old shaft to a new bearing is to try the shaft in the bearing before pressing the bearing into the crank case housing or wherever it belongs; if the bearing is too tight, ream it out to fit. In most cases after the bearing is pressed in, it will have to be finish-reamed. However, before reaming try the shaft.

We have found in our service shop that the best average clearance between a shaft and bronze bearing is from .001 to .0015" all around, depending of course on the size of the shaft. The larger diameter shafts usually take a .0015" clearance and the smaller diameter shaft .001". On extremely small diameter shafts of  $\frac{1}{2}$ " or less, the clearance is usually a trifle less than .001".

## CRANKSHAFT

To remove the crankshaft from crank case, follow the procedure outlined for various models under "Crank Case", see pages 40, 41, 42.

After cleaning the shaft thoroughly, check for trueness and straighten if necessary in lathe centers as described on page 40. Also check shaft for scores, and for heat discoloration. Minor scores can be removed or reduced by dressing with fine emery cloth while the shaft is spun in a lathe.

Excessive scores require that shaft be replaced. Shafts showing excessive heat discoloration should be checked for hardness as a shaft with too soft a surface cannot be used. See Hardness Table, page 43.

Heat discolored or scored shafts should be micrometer checked for roundness on all pins and journals. See table on Crankshaft Sizes, pages 67, 68.

Crankshafts on all motors above five horsepower should be checked minutely for cracks. A good method for detecting cracked shafts is to hang the shaft on a cord or wire and strike it with a hammer. A sound shaft will give forth a clear ringing sound. If the shaft has a dull ring, one or more severe cracks may render it useless.

If the crankshaft is suspected of having cracks, wash the shaft in outboard fuel (gas) mixture, and blow off the excess with air. Drop shaft gently on steel block. Raise it up into the light and examine it carefully for tell-tale oil oozings which will reveal places where shaft is cracked. Any shaft with a sizeable crack should be replaced to avoid serious damage to the motor.



**CRANKSHAFT**

**ROCKWELL HARDNESS TEST—C SCALE**

Mate .....	54 to 60
Ranger .....	54 to 60
Sportsman .....	54 to 60
Sportwin .....	54 to 60
Zephyr .....	54 to 60
Lightfour .....	54 to 60
Sportfour .....	56 to 60
Speeditwin .....	54 to 58
Speedifour .....	56 to 60
Cub .....	54 to 60
Pal .....	54 to 60
Ace .....	54 to 60
Handitwin .....	54 to 60
Lightwin .....	54 to 60
Fleetwin .....	54 to 58

**SECTION XVII**

**PROPELLERS**

**STANDARD PROPELLERS SUPPLIED WITH MOTORS**

The propeller supplied with your outboard was selected after exhaustive tests as the one best suited to deliver maximum speed and power on a wide range of typical boats. Owners occasionally use their motors on boats that are sufficiently different from the average to warrant the use of a propeller that will provide more efficient service on such a hull.

**INFORMATION ABOUT PROPELLERS**

The sizes of propellers are always given in two dimensions—pitch and diameter. The pitch is the distance the propeller would travel in one revolution if the water were a solid. Thus, a 12" pitch wheel is one that would advance 12 inches with one complete turn. The diameter is measured from tip to tip of the blades on a two-blade wheel; on a 3-blade the diameter is that of the circle described by the periphery of the blades. The slip is the difference between the actual and theoretical advance of the propeller during one revolution, and is caused by the fact that water not being a solid, permits the propeller to "slip". Slippage may run from 20% to as much as 40%, depending upon the efficiency and speed of the propeller. In general, heavy boats or loads require propellers with greater diameter and blade area and less pitch for efficient operation. With light, fast-lined boats, the reverse is true.

The boats on which the smaller sizes of outboards are generally used do not vary sufficiently in performance to require propeller changes. With the

larger, more powerful motors, appreciable gain can be obtained with a change to the best suited propeller.

**STRAIGHTENING BENT PROPELLERS**

A motor with a bent propeller cannot perform efficiently. A bent propeller may even cause hard starting; occasionally a motor with a bent propeller cannot be started at all. Excessive motor vibration is also caused by a bent propeller.

Propellers that are not damaged too severely can be straightened. Best results are obtained by using a propeller form (see Figure 58) on which the propeller is mounted and the dents and bends pounded out with a hammer. Bronze or brass propellers are more ductile than aluminum, consequently will better stand the strain of bending and straightening.



Figure 58

**OPTIONAL PROPELLERS**

For the larger motors we have optional wheels available for high speed and heavy duty service, as follows:

**HIGH SPEED**

Part No.	Model Motor	Shipping Weight
275207	Lightfour .....	2 lbs.
200279	Sportfour .....	2 lbs.
100692	Speeditwin .....	2 lbs.

**HEAVY DUTY**

193964	Lightfour .....	2 lbs.
200278	Sportfour .....	3 lbs.
200281	Speedifour and Speeditwin .....	3 lbs.



When ordering, give full information as to motor number, make and model of boat, beam and length, weight of hull, load to be carried, width, and depth of transom. Prices on application and subject to change without notice.

### CAVITATION

When the propeller spins in a pocket of air sucked down to the propeller, causing the engine to race wildly, the action is referred to as cavitation. This is usually caused by using a propeller of too great pitch which keeps the motor from running up to its most efficient R. P. M., causing the water to be pushed aside faster than it flows in. This occurs most often on racing hulls. Such a fault can be cured only by the selection of a more efficient propeller.

On conventional boats cavitation is caused by mounting the motor too high on the transom.

### USING PROPELLERS OF TOO LOW PITCH

When a propeller of too low pitch is used on a fast racing boat the motor "winds up" excessively at rate of R. P. M.'s that may cause serious damage to bearings, crankshaft, etc. This condition should be cured immediately by selecting a propeller that will enable the motor to run at or near its recommended R. P. M. A number of trials may be necessary to determine which propeller is most suitable, particularly on a racing hull.

## SECTION XVIII

### BEARINGS

#### ROTARY VALVE — CENTER BEARING

This method for admitting the fuel to the crank case is employed on the Elto Fleetwin, the Evinrude Speeditwin and all the Evinrude four cylinder motors. The center bearing forms one part of the valve; the crankshaft, the other. The "pie" cut in the shaft admits a charge of gas with each revolution.

There is no adjustment on this valve and it seldom requires attention. Occasionally it may stick and score due to overheating caused by lack of lubrication. A loose screw or other part of the motor may go through the valve, causing damage. When possible, smooth out burrs, nicks, etc., with a file, and fill deep holes or scores with solder. If damaged severely, parts must be replaced for satisfactory operation.

**SPEEDIFOUR**—If the center bearing on this model is allowed to become loose and the motor is run in this condition, the valve will rub and through excessive wear will become too small, resulting in hard starting and inefficient operation. Such valves must be replaced. (If not worn too badly such a valve

may be reconditioned at the factory by copper plating. The crank case must accompany the valve on such orders.)

#### UPPER CRANK CASE BEARINGS

The upper crankshaft bearing on the Cub, Mate, Pal, Ranger, Ace, Sportsman, Handitwin, Sportwin, (except older models) and Zephyrs is integral with the crank case. If worn excessively, the entire crank case requires replacement. See table of Bearing Clearances, Page 63.

On the Lightwin, Fleetwin, Lightfour, Sportfour, Speeditwin and Speedifour, the upper bearings are separate from the crank case and are replaceable. These bearings must be pressed out on an arbor press, and similarly replaced.

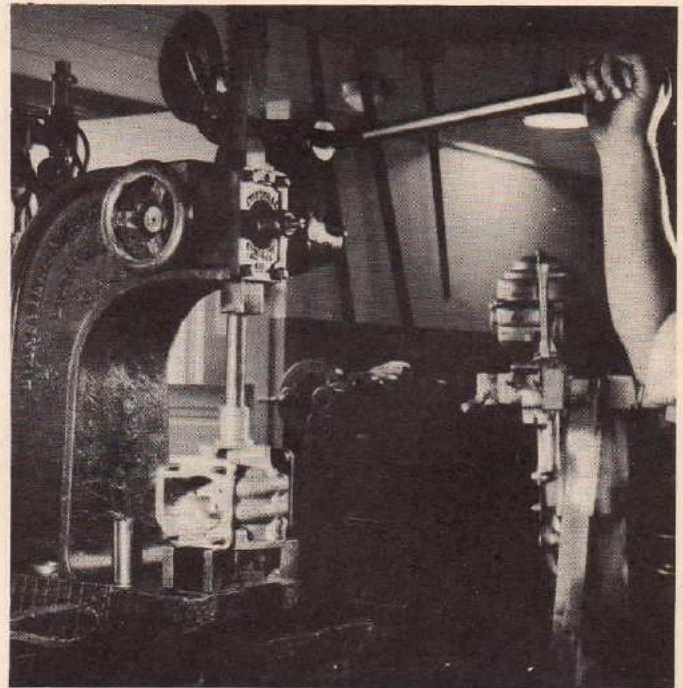

Figure 59

#### LOWER CRANK CASE BEARINGS

**CUB, MATE, PAL, RANGER, ACE, SPORTSMAN, HANDITWIN, SPORTWIN, LIGHTWIN, ZEPHYR, FLEETWIN and SPEEDITWIN:** The lower crank case bearings on these models are attached by means of 4 screws. When excessively worn these bearings must be replaced. However, such instances are rare, and are usually caused by lack of proper lubrication or by careless winter storage when moisture causes the crankshaft to rust and "freeze" to the bearings. Check clearance with table on page 63.

**LIGHTFOUR, SPORTFOUR, SPEEDIFOUR**—On these models the bearing bushing is replaceable without necessity of replacing the bearing cap. Press bushings in and out on an arbor press. See table, page 63, for clearances.



## SECTION XIX

### MUFFLERS

CUB, MATE, PAL, RANGER, ACE, 1940 SPORTSMAN—On these motors the muffler consists only of the down-pipe which leads the exhaust gases to the underwater outlet.

This pipe should be replaced in the event it becomes loose or suffers breakage due to collision.

To remove old tube, collapse it where it is inserted in exhaust relief casting. Press in new tube, drill hole through tube in line with hole in casting and rivet with aluminum rivet supplied for this purpose. (Part No. 132817.)

SPORTWIN, HANDITWIN, LIGHTWIN, FISHERMAN, LIGHTFOUR, FLEETWIN, SPEEDITWIN, SPEEDIFOUR—These are all cast aluminum mufflers, cast in one piece, cooled by the discharge water after it cools the cylinders. Examine for cracks due to injury from collisions, etc. Minor cracks or holes can be welded. If broken too seriously, replace with new muffler.

ZEPHYR—This muffler is made of 3 aluminum die castings. If leakage occurs in the joints, take apart, clean and reassemble, using Gasoila Varnish Sealing Compound to seal the joints. (See Accessories Catalog.) If any piece becomes broken it can be replaced separately.

### AUTOMATIC EXHAUST RELIEF

ON ALL NON-REVERSING MOTORS—This feature is incorporated in the mufflers of all Evinrude and Elto motors and is completely assembled at the factory and requires no adjustment or replacement. However, it is important to clean and scrape carbon from holes in tube and recess in muffler.

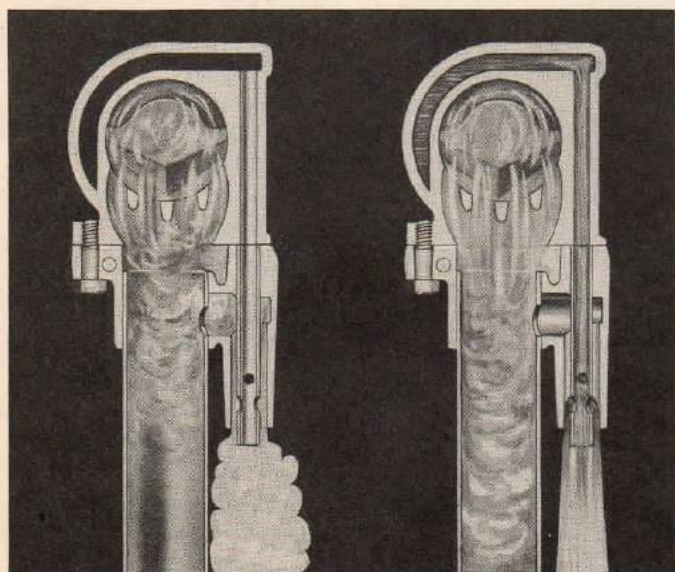

Figure 60

### WATER ENTERING MOTOR FROM MUFFLER

Owners whose motors show signs of water having entered from the muffler should be warned against tilting the motor too fast as this does not give time for water present in the muffler to drain out through the exhaust tube. The bracket is provided with stops to prevent the motor from tilting too high. On the Zephyr these stops are sometimes broken from too violent tilting.

## SECTION XX

### CARBURETORS—CHECK VALVE TYPE

MATE and CUB—On these models the carburetor body is cast integral with the crank case. To remove the check valve assembly, disconnect fuel line and take out the two screws at the bottom of carburetor body, and assembly will drop out.

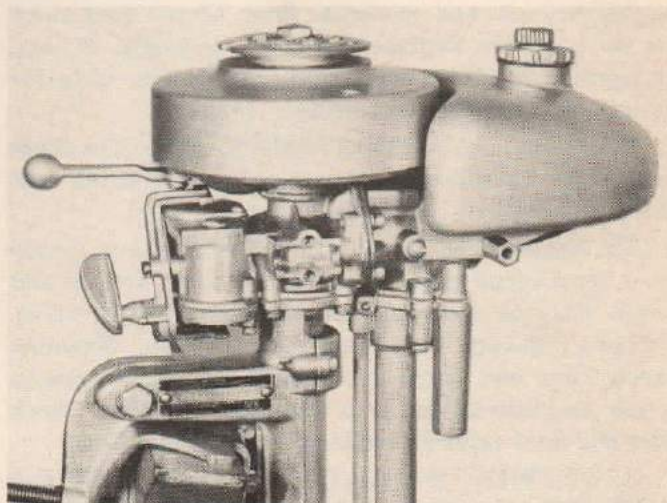

Figure 61

Screw out needle valve. Remove spring cage. Lift out check valve. Remove strainer body and strainer. Clean parts. Examine needle valve for wear at tip. If worn, replace, as taper should be perfect for satisfactory operation. Check spring for breakage. Be careful not to change tension of spring. Spring worn flat at top or bottom should be replaced.

Examine check valve and valve seat for wear or score marks (due to faulty lapping by customer). If valve does not seat properly, lap it with No. 1A Cloverleaf grinding compound, using a back and forth twisting motion under light pressure and taking care to keep valve in vertical position on seat. In installing check valve be sure that there is clearance between top of valve and relief pin. Remove all parts and wash carefully in clear gasoline. Reassemble parts.

Examine check valve spring cage bumper. If flattened excessively or loose, replace with new part. New bumper should be sealed in position with small application of shellac.



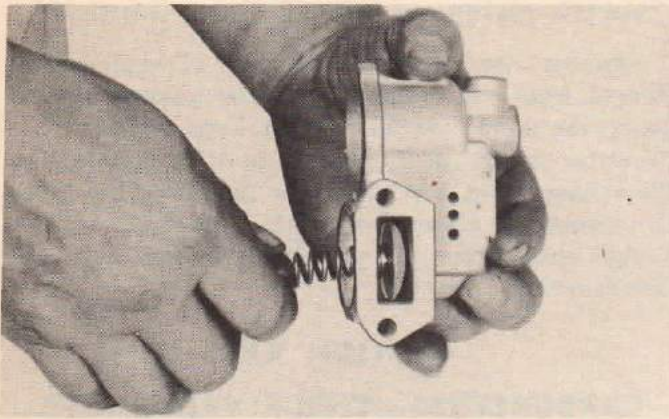

Figure 62

The float and float valve are held in the chamber by a cover fastened with three screws. Remove and check float and float valve. If float is loggy (heavy from saturation) replace it, or carefully and thoroughly dry out and re-shellac float. Check float valve for wear in seat. Replace if worn or damaged. If bent, straighten carefully. Reassemble parts. See table for carburetor check valve settings. (Right.)

RANGER, PAL, SPORTSMAN, ACE—On these models the carburetor is separate from the crank case and is fastened to crank case by two screws.

To disassemble, remove fuel line. Remove carburetor from crank case. Remove four cover screws and cover. Remove spring, check valve and needle valve. Remove strainer body screw at bottom. Examine check valve and check valve spring, and if necessary repair as outlined for Cub and Mate models. Check float and float valve as outlined for Mate and Cub.

SPORTWIN, HANDITWIN, LIGHTWIN and FISHERMAN—These carburetors are similar to the above. The check valve and float bowl covers are separate. All parts are similar to those in preceding carburetor sections and should be serviced identically.

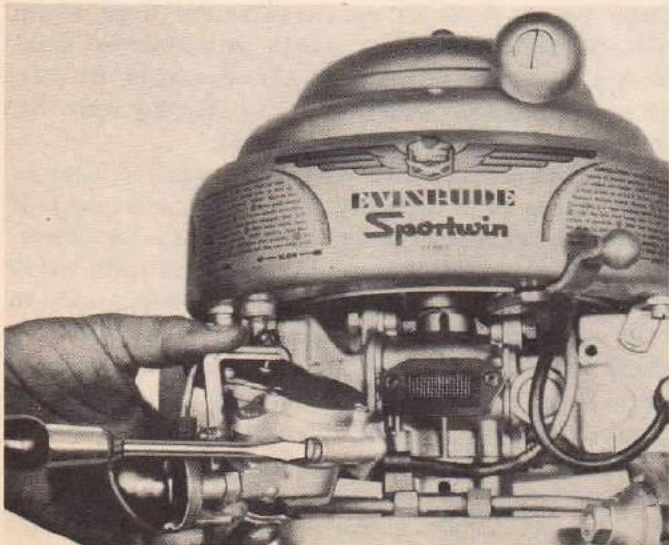

Figure 63

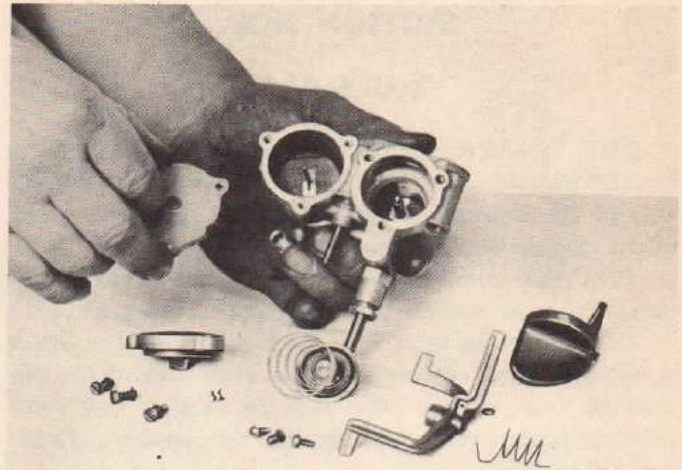

Figure 64

**CARBURETOR VALVE LIFT — SPRING PRESSURE — FLOAT LEVEL**

The following list covers dimensions of carburetors now being used. If information covering older type carburetors is desired, same will be supplied on receipt of your request.

Motor	Valve Lift	Spring Pressure With Valve on Seat	Approximate Float Level with Float Chamber Full. From Top of Bowl to Gas Level
Mate .....	.050	28 grams	5/8
Ranger .....	3/32	3 oz.	23/32
Sportsman .....	1/8	3 oz.	23/32
Sportwin .....	9/64	3 oz.	13/16
Zephyr .....	—	—	3/4
Lightfour .....	—	—	3/4
Sportfour .....	—	—	3/4
Speeditwin .....	—	—	1
Speedifour .....	—	—	7/8
Cub .....	.050	28 grams	5/8
Pal .....	3/32	3 oz.	23/32
Ace .....	1/8	3 oz.	23/32
Handitwin .....	9/64	3 oz.	13/16
Lightwin .....	3/16	6 oz.	13/16
Fleetwin .....	—	—	3/4

ZEPHYR and LIGHTFOUR—These carburetors are identical except for the venturi sizes. The carburetors are of the float-feed auto type with throttle speed control.

TO DISASSEMBLE: Remove 3 float bowl cover screws. Remove primer lever screw. Remove float needle lock, pin and sleeve. Lift off cover. Remove strainer screen plug from bottom of bowl. Push float needle downward and remove float. Remove adjusting needle gland nuts and high and low speed needles.



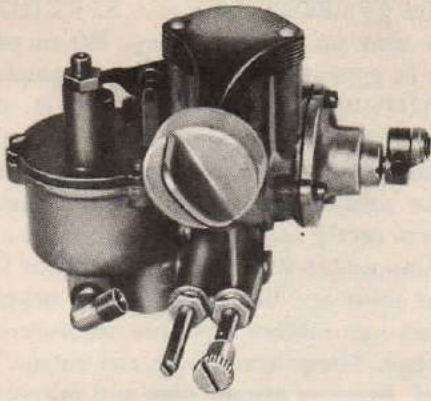

Figure 65

(High speed needle has the large knurled head and must be at the right facing the motor.)

Clean all parts and passages thoroughly. Blow out channels with air.

Remove throttle valve assembly as follows:

Remove Throttle Valve Cover (C).

Pull up on valve (D) so valve face is flush with face of carburetor.

Turn valve (D) to left until boss (E) on valve is in line with lower throttle valve cover hole (F). (See sketch below.)

Slowly pull valve from chamber.

When replacing valve reverse above procedure.

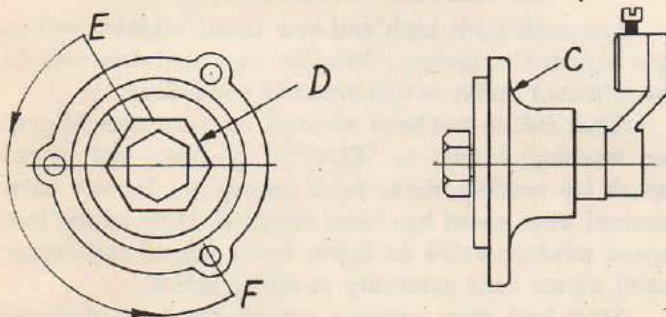

Figure 66

Inspect float and if loggy (heavy with oil and gas) dry out and shellac. Inspect float needle and if seat is worn or damaged, replace. Also be sure needle is perfectly straight. Reinstall float needle and float, with brass float locks engaged in top and bottom notches in float needle.

Inspect both needle valves for damaged or bent tips. Replace if damaged. Reinstall, preferably using new packings. Slide needle into packing gland nut; slide packing over needle; screw needle into place. Slide packing into place and turn in packing gland nut. Draw up tightly with wrench until tension keeps needle valves in position. Do not force or use hard packing as pressure may crack carburetor body.

Reinstall float bowl cover and float needle lock, pin and sleeve. The air inlet valve on top of float bowl requires only cleaning with gasoline and air.

### NEEDLE VALVE SETTINGS

The approximate setting of the low speed mixture valve is 1 turn from closed position and of the high speed mixture valve  $\frac{1}{2}$  turn from closed position.

Always adjust low speed mixture valve first and do not change this setting when adjusting high speed valve.

**CAUTION:** To eliminate the necessity of readjusting the high and low speed mixture valves every time motor is used it is advisable to measure the quantity of lubricating oil mixed with gasoline very accurately. Care should also be taken that the same grade and type of both oil and gasoline are always used.

### FLOODING

It sometimes happens that too much gasoline is drawn into the crankcase and cylinders when starting motor, especially when the motor is warm. When this occurs, the charge cannot be fired as the mixture is too rich to be explosive, therefore this excess gasoline must be eliminated.

To do this, first note setting of needle valve(s) on carburetor so this can be returned to readily, then gently close needle valves and pull starter rope until motor starts, allowing motor to run until it stops. Now, reset needle valve(s) and follow instructions relative to starting WARM motor.

### MIXTURE LEVER FRICTION

Should the mixture lever needle become so loose that it will not remain in a set position, it can be tightened by drawing down on the packing nut through which the mixture lever needle passes. If tightening of the packing nut will not tighten mixture lever needle, it may be necessary to replace the packing. To replace packing, remove mixture lever from carburetor, also packing nut. Remove old packing, replace with new and reassemble. Be sure not to add too much packing as in some cases this makes nut protrude too far and cam collar on needle will stop needle before it seats.

The lever itself may come loose and move out of position on the needle. Set needle valve at best running position and move lever back to correct setting as called for by the instructions. Tighten set screw.



## CARBURETORS—(Continued)

**SPORTFOUR and FLEETWIN**—This carburetor is of the auto type with float chamber and throttle control and plunger type primer.

**TO DISASSEMBLE:** Remove 3 float cover screws and lift off float cover. Remove float lever pinion screw and lift out float and float valve.

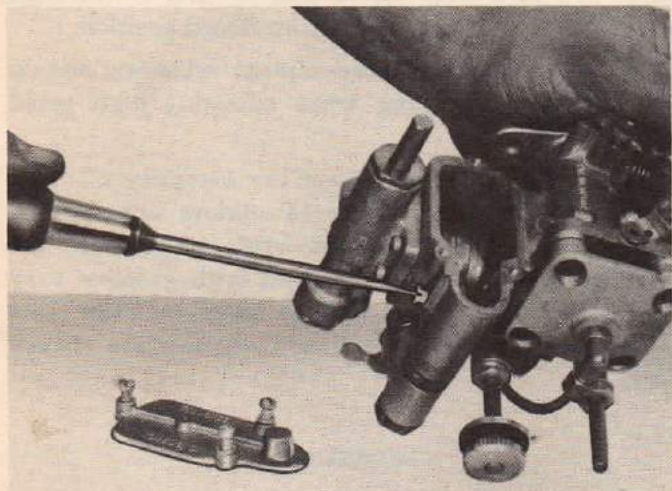

Figure 67

Check float for leak. If float leaks, replace, as soldering is a delicate operation because heat expands air inside. Check float needle and seat for wear. Replace both if either is worn or damaged.

**PRIMER:** Remove primer plunger stop; remove plunger and spring. Examine parts for wear. Replace if worn excessively. Primer check valve can be cleaned without removal (which sometimes damages the threads). Remove and clean primer pipe assembly. Remove and clean primer outlet check valve without attempting to disassemble valve.

By wiggling throttle shaft, check for wear. If worn, replace shaft. Remove needle valves. Proceed as outlined under Zephyr carburetor. Remove nozzle plug screw to permit cleaning inlet nozzle. Clean all parts thoroughly with gasoline and reassemble carefully. Assemble needle valves with care as outlined under Zephyr carburetor.

### CARBURETOR ADJUSTMENT

**SPORTFOUR and FLEETWIN**—For information on adjusting carburetor, see starting and operating instructions, page 20.

### FLOAT LEVELS

Float levels on ZEPHYR, LIGHTFOUR, SPORTFOUR carburetors are set at the factory with the float held in notches on float valve stem. These settings should not be changed. If the float locks become bent or otherwise damaged, they should be repaired or replaced.

On the SPEEDITWIN and SPEEDIFOUR the floats are also set at the factory. When properly set these are in approximately horizontal position.

**SPEEDITWIN**—This carburetor is also of the auto type with float feed and throttle adjustment.

**DISASSEMBLY:** The right hand side of this carburetor consists of the venturi and throttle valve. These parts rarely require dismantling for adjustment.

To disassemble float chamber, remove four screws from float cover and lift off cover with primer plunger.

The primer seldom requires replacement, except for breakage. The primer piston rod button is threaded to the rod. Remove primer pipe and primer body with primer check valve and spring. To check valve, remove primer body screw and push down on valve stem until valve is exposed. If worn or damaged, replace, or lap in with fine grinding compound. (See page 46.)

Remove carburetor float pinion screw and float, and float valve can be removed. Remove float valve seat. Check float for leaks. Check valve and seat for wear. Replace if worn.

Remove needle valves. The low speed (horizontal) valve is the one most likely to accumulate dirt. Check for wear or damage. These valves seldom require attention but should be replaced if necessary.

Remove clean-out screws.

Thoroughly clean all passages with gasoline. Reassemble carefully. Replace all gaskets that are worn or damaged.

### TO ADJUST MIXTURE VALVES

Although both high and low speed mixture valves are adjusted at factory, these for best operation should be adjusted under actual running conditions.

After motor has been warmed up, turn control grip on steering handle to "SLOW" position and retard spark by moving timer lever slowly to the left until desired slow speed has been obtained. Now adjust low speed mixture valve on lower front side of carburetor until motor runs smoothly at idling speed.

After best slow running setting has been obtained move timer lever to the right and turn control grip on steering handle towards "FAST." Now adjust high speed mixture valve by turning valve wheel slowly to the right or left until best operating setting has been obtained.

The approximate setting of the low speed mixture valve is  $\frac{1}{2}$  turn from closed position and of the high speed mixture valve  $\frac{3}{8}$  turn from closed position.

Always adjust low speed mixture valve first, and do not change this setting when adjusting high speed valve.

**SPEEDIFOUR**—This model is equipped with auto type, float feed carburetor with throttle control.

To disassemble, remove 3 float cover screws and lift off cover. Remove float lever tension screw and take out float and inlet needle valve.



Remove inlet valve seat adjacent to base of float bowl.

Remove drain plug at bottom of carburetor bowl. Remove needle valves. Check all valves for wear or damage. Replace valves with seats if necessary. Jets need not be removed unless damaged.

Clean all parts and channels carefully. Reassemble carefully.

## SECTION XXI

### SIMPLEX STARTER

**REMOVAL**—Remove 3 screws that hold starter housing on tank. Lift off starter assembly.

**DISASSEMBLY**—It is necessary to take the starter apart to replace a broken starter cord, spring or pin, or otherwise repair the starter.

**RANGER, SPORTSMAN, SPORTWIN, ZEPHYR, LIGHTFOUR:** To replace broken or worn starter rope—

1. Remove starter rope handle from old starter rope.
2. Disassemble starter. Remove acorn starter nut and starter lock nut and shim.
3. Remove starter pulley shaft.
4. Pull out starter pulley and spring. Leave starter spring plate in position. Be careful not to lose starter shim on plate.
5. Remove old rope from starter pulley.
6. Place spring in position on top of starter pulley with loop on inside end slipped over anchor pin.
7. Place spring and pulley on fixture as shown in photograph. Slide free end of spring between two pins on fixture.

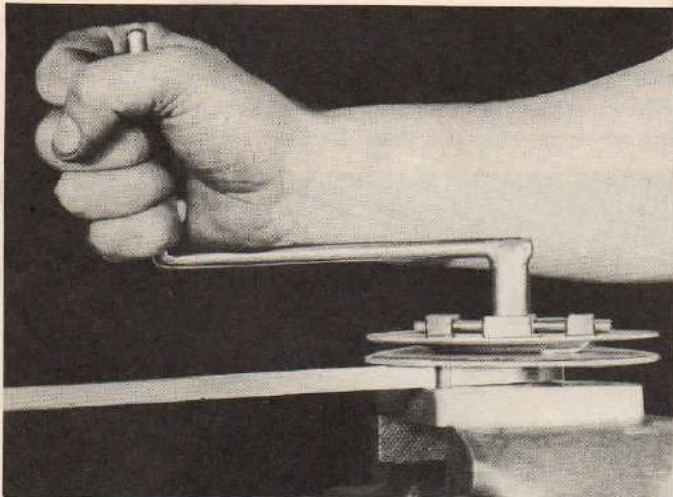

Figure 68

8. With fixture crank, wind spring tight. Be sure spring is wound counter clockwise, then release sufficiently to allow loop to line up with holes drilled in edges of pulley. Slide a pin through holes in pulley to engage loop or opening.

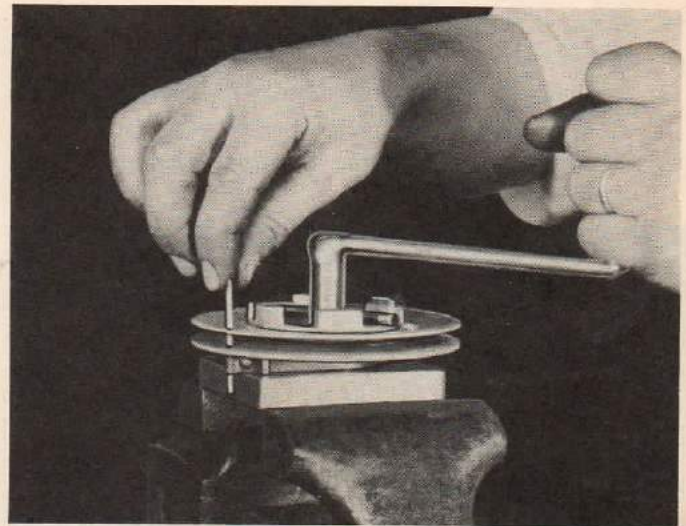

Figure 69

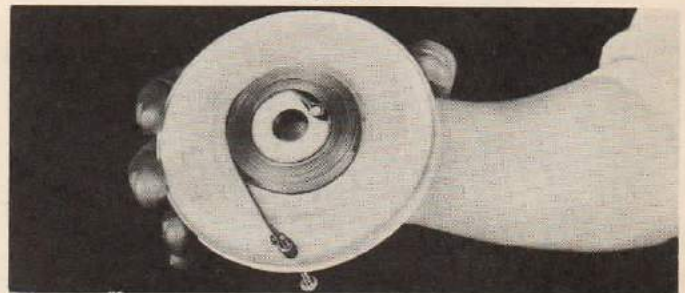

Figure 70

9. Slide free (starter handle) end of cord through slot in pulley. Engage anchor hook on end of cord on reinforced face of pulley.

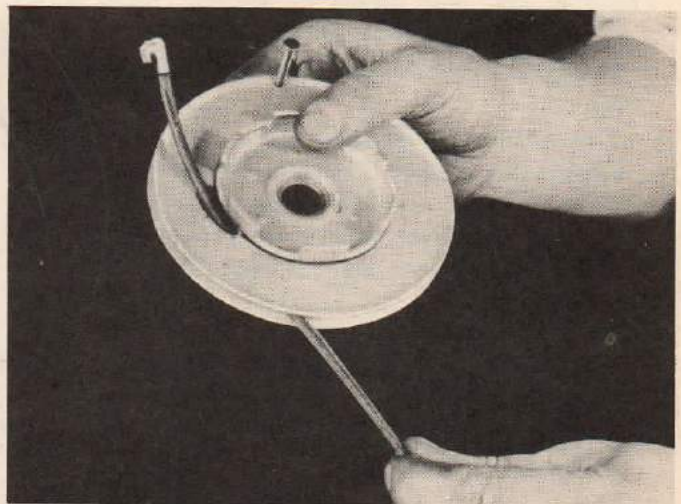

Figure 71

10. Slide free end of cord through hole in starter housing with a half coil of rope on pulley.
11. Place pulley with spring carefully into starter housing with shim in position on pulley plate, and with loop on spring lined up exactly with pin in starter housing. Insert starter pulley shaft in pulley.



12. Place shim on pulley shaft and install starter lock nut loosely.
13. Tie knot in starting cord close to starter housing so cord can't wind up on starter pulley.
14. Press pulley down into position forcing out pin which held spring.

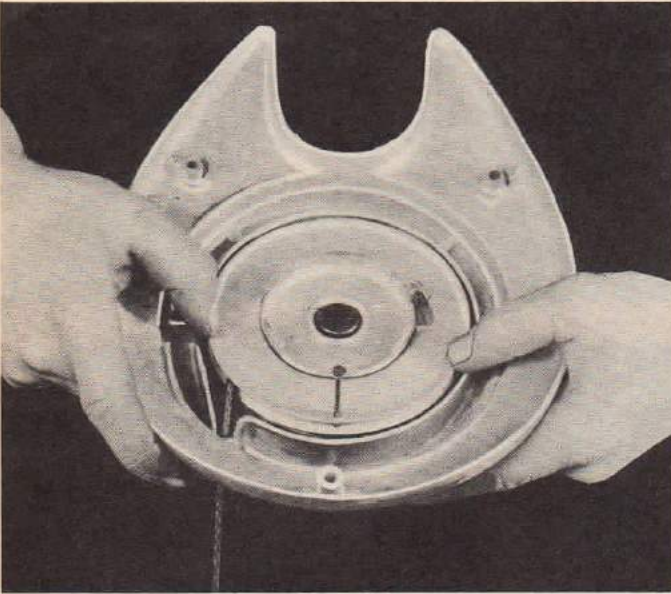

Figure 72

15. Draw up lock nut.
16. Slide starter handle on cord with small end toward starter housing. Install starter handle clamp on free end of cord. Separate 2 halves of clamp. Loop end of cord and clamp in position. Turn screw down tight. Slip clamp into handle.
17. Untie knot in cord and cord will wind up in pulley.
18. Reinstall starter assembly on motor. Do not pull screws down tight until starter centers exactly. While screws are still loose, pull starter rope slightly so starter rope drops into position with pulley engaged on starter pawl. Tighten starter housing screws.
19. **TO CENTER STARTER:** With the starter lock nut loose, insert a 3/16" x 4" pin through center of starter shaft into crankshaft. Pull starter rope slowly and release, and draw up lock nut. Install acorn nut.

**REPLACING STARTER CORDS BEFORE BREAKAGE OCCURS — SAVES TROUBLE**

It is far easier to replace a worn starter cord before actual breakage occurs. Merely pull cord out as far as possible, lock pulley in position, and replace worn cord with a new one.

The Simplex Starter cords of all motors that come in for repairs should be checked for wear.

**TO INSTALL NEW SPRING IN SIMPLEX STARTER**

Proceed exactly as above. New springs come ready for use.

**TO REPAIR SIMPLEX STARTER DRUM ASSEMBLY ON RANGER TO LIGHTFOUR INCLUSIVE**

In the event starter cord sticks, starter pulley may not be centered on crankshaft. If difficulty persists after centering accurately, look for cause of trouble in starter drum assembly. After removing starter, check the following:

1. Pawl springs broken
  2. Pawls or pawl pins bent or broken
  3. Equalizer damaged.
- Repair or replace parts as required.

**TO REPAIR SIMPLEX STARTER ON SPORTFOUR**

In this model the starter drum assembly is removed with the starter housing. If pins, pawls or springs become broken or bent, repair or replace as needed.

**TO CHANGE CORD ON SPORTFOUR SIMPLEX STARTER**

On this model it is necessary to disassemble the starter to change a worn or broken cord. Remove old cord by pulling it out from the anchored end.

To install new cord, hold starter housing in vise or on pegs, or lay on board and hold with nails through starter attaching holes. Turn starter drum 3 1/4 turns counter clockwise (as far as it will go) and hold in position with pin as shown in photo. Insert free end of starting cord in anchor slot, lead it through hole in starter cover. Install starter cord handle. While holding cord remove pin and allow starter cord to rewind.

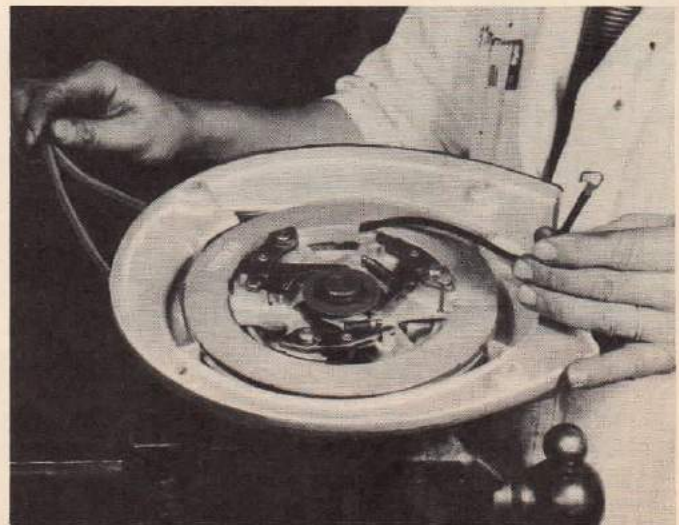

Figure 73



### TO CHANGE SPRING ON SPORTFOUR SIMPLEX STARTER

To replace spring remove acorn and lock nut and pulley shaft. Lift out starter pulley assembly and install new spring as outlined for other models, above.

This starter does not need to be centered on crankshaft. Care should be taken to reinstall all washers or shims in the position originally occupied.

## SECTION XXII STERN BRACKETS

Stern brackets on the CUB, MATE, RANGER, PAL, SPORTSMAN, ACE, SPORTWIN, HANDITWIN and ZEPHYR are die cast and require replacement in event of breakage. Brackets on remaining models are sand cast and experienced welders can often repair breaks satisfactorily.

**THUMB SCREWS**—When these become bent, causing the screw to bind, it is best to cut off screw, remove the stub and replace with new straight screw.

**THUMB SCREW BUTTONS**—When these become lost, new buttons should be installed. Rivet securely and carefully, using a vise or other solid base on which to rivet opposite end of screw.

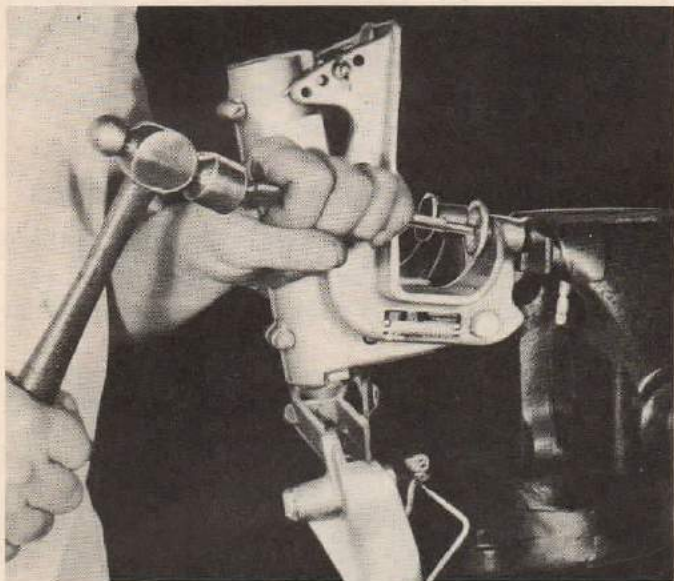

Figure 74

### PIVOT BEARING ASSEMBLY AND CO-PILOT

**MATE and CUB**—Two screws fasten the pivot bearing to the drive tube. A rubber bushing is located inside the bearing. Check this for wear or oil saturation. Replace if necessary, also lower one-half bushing at bottom of pivot bearing. In reassembling, tighten screws to point where friction is sufficient to hold motor on its course.

**PAL and RANGER**—This pivot bearing is equipped with rubber Co-pilot, located at bottom of pivot bearing. To disassemble, first remove six clamp screws. Replace steel bearing bushings if worn, both upper and lower. Replace pilot rubber if worn or swollen with oil. Apply small amount of grease, but do not apply this to rubber. Draw upper screws up to allow steering with slight amount of friction and lock with screw locks. Tighten lower screws, making sure that lockwashers are installed.

**TILTING BOLT** should be kept tight enough to keep motor tilted in any desired position.

**SPORTSMAN and SPORTWIN (with Full Pivot Reverse)**—To disassemble remove drive tube screw and pivot bearing clamp screw. Remove gear housing, after which motor can be lifted out of pivot bearing. Examine fiber bushing for wear; press in new one if necessary.

The Co-Pilot is properly adjusted at factory. When necessary, readjustment can be made by tightening or loosening the adjustment screw at upper end of pivot bearing.

**REVERSE LOCK**—This requires little attention. If spring or other parts are broken or damaged, replace.

**ZEPHYR**—To disassemble, remove drive tube screw and pivot bearing clamp screw. Housing can be removed and motor lifted out of pivot bearing. Remove tilting bolt nut and unscrew tilting bolt. Take two halves of pivot bearing apart and examine upper steel bushing for wear. Examine lower fiber bushing and rubber liner. Replace if necessary because of wear. Reassemble, drawing all screws up tight. In order to properly insert driveshaft tube screw it is necessary to apply pressure to top of motor to compress rubber shock absorber balls. Steering tension is adjusted by screw with spring near upper part of pivot bearing.

**STEERING HANDLE SUPPORT.** This member may become bent or broken. If not bent too badly, straighten. Rubber shock absorber balls (12) should be replaced if badly swollen or worn.

**LIGHTFOUR, SPORTFOUR, SPEEDITWIN, SPEEDIFOUR**—The two halves of the pivot bearings on these models are disassembled by removing the upper pivot bearing clamp stud nuts and the lower pivot bearing clamp screws. Examine fiber bushing. Replace if worn. Also replace steering handle support rubber if swollen or worn.

In reassembling, take special care to line up both halves, tapping with light hammer to line up. Also place bearing in its proper angle position before tightening clamp screws.



**SECTION XXIII**  
**GEAR HOUSINGS**  
**MATE AND CUB**

Before removing the gear housing, remove the propeller wheel. This housing is detached from the motor by removing the three pump body screws. The housing will then drop down with the drive shaft. Remove 2 gear housing cap screws, and remove gear housing cap. This releases the propeller shaft and gear. Pull out drive shaft and pump impeller assembly.

Remove drive shaft gear which has dropped off of drive shaft. Wash all parts. Be sure not to lose drive and propeller gear thrust washers.

Check gears, shafts and bushings for wear. Bushings are integral with gear housing. If any parts are badly worn, replace with new.

Check pump parts for wear. The gear housing forms the lower part of the pump body. If any parts are worn excessively, they should be replaced.

Check grease seals. Replace if damaged by having run dry, or otherwise injured.

To reassemble, first slide thrust washer over inserted end of driveshaft. Slide driveshaft gear into position on spline of shaft. Insert propeller shaft gear thrust washer, and slip propeller gear and shaft into position.

Insert new cap gasket and shellac to cap to hold in position. Assemble cap to housing. Turn shaft to see that gears run freely. If too tight it may be due to new grease seals. However, if gears are meshed too tight, this can usually be felt while turning shaft. To obtain free adjustment, add a brass shim between propeller shaft gear and the thrust washer.

Fasten housing to pump body, making sure that pump deflector pin is still in place in the groove in pump body. Remove both grease plugs and fill housing with Evinrude Gear Grease. Insert grease plugs. Install shear pin and propeller wheel. Do not draw propeller nut up too tight.

**RANGER AND PAL**

**BROKEN HOUSINGS, PROPELLER, PUMP BODIES**—These parts are die cast aluminum alloy and must be replaced if broken. Check all castings carefully for cracks.

To remove housing from motor, remove four drive tube screws. Slide housing off with pump and driveshaft.

Hold housing in copper jawed vise clamping housing at thin front section.

Remove propeller cotter pin, propeller nut, propeller and shear pin. Remove two cap screws and remove gear housing cap. Remove propeller shaft and gear, making sure thrust washer is not lost.

Remove three pump body screws. Separate and remove pump body from gear housing. Pull out driveshaft. Take driveshaft gear and thrust washer from gear housing.

Wash all parts. Examine sealing washer (cork) and replace if worn or damaged by removing aluminum sealing washer retainer.

Examine pump impellers and deflector for wear or sand scores. Replace if too badly worn or damaged. Scratch-mark driveshaft for position of pump parts. These parts must be pressed off and on in an arbor press, and pressure should be supplied at hubs of parts so that parts will not break during installation.

Check gears, shafts and bushings for wear. Replace if necessary.

Reassemble. Slide driveshaft into housing; place thrust washer over spline of shaft and slide shaft into gear. While making sure that deflector pin is in groove, install pump body, drawing three screws up tight. Turn driveshaft with fingers to make sure pump turns freely.

Put propeller shaft thrust washer over end of propeller shaft. Slide shaft with gear into position. Move shaft back and forth to check gear mesh. If too close add brass shim between gear and thrust washer.

Shellac new gasket to gear housing cap. Install cap; draw 2 screws up tight. Install propeller wheel and shear pin. Turn propeller wheel to see that gears run freely. A small amount of end play in the propeller shaft is normal and need not cause concern.

Remove grease plugs and fill gear housing with Evinrude Gear Grease. Install grease plugs.

**SPORTSMAN, ACE, SPORTWIN, HANDITWIN**

**BROKEN HOUSINGS, PROPELLER, PUMP BODIES**—These parts are die cast aluminum alloy and must be replaced if broken. Check all castings carefully for cracks.

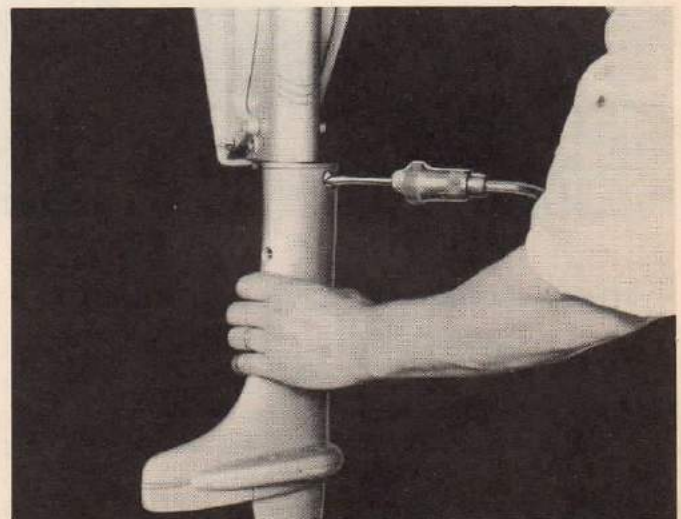

Figure 75



To disassemble, remove propeller nut cotter pin, propeller wheel and shear pin. The propeller clutch ring, hub washer and nut washer will come off with the wheel. If propeller clutch ring is worn or damaged, replace.

Remove drive tube screw and pump body clamp screw. Slide off housing with driveshaft and pump.

Take out six pump body screws (2 long, 4 short), and remove gear housing with driveshaft and pump assembly.

Clamp skeg of housing horizontally in copper jawed vise.

Remove 2 gear housing cap screws; remove cap. Remove propeller shaft and gear. Pull out driveshaft. Remove thrust washer and gear from housing.

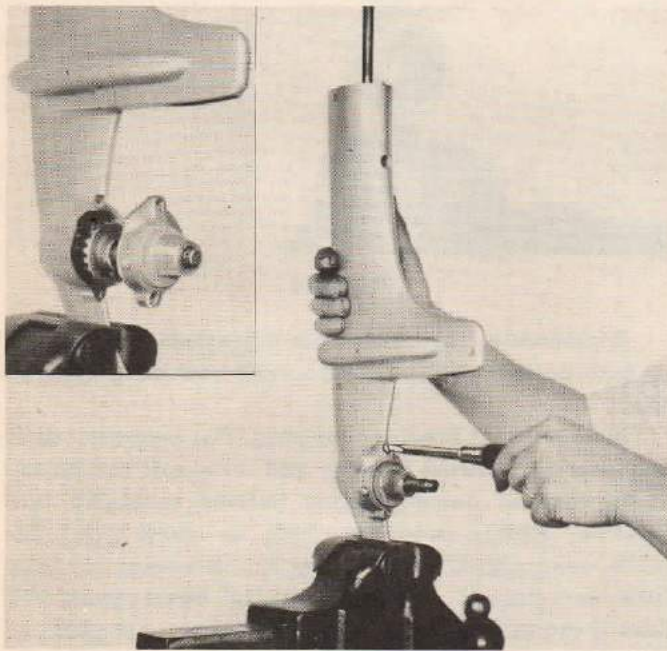

Figure 76

Wash all parts. Remove propeller shaft thrust plug and shims (if any) from gear housing.

Check grease seals. Remove retainer and seals. Replace if worn by running dry or damaged. On motors that have had considerable service, it is always good policy to replace grease seals.

Check pump parts, bushings, gears and shafts for wear. Replace if necessary. See Ranger gear housing, page 52, for pump parts installation.

Reassemble, slide driveshaft into housing (Figure 77), making sure that deflector pin is in pump body groove. Slip thrust washer into place and slip key into gear and gear onto shaft. Be careful that drive gear key is not lost or does not get out of position.

Assemble gear housing to pump body, drawing six screws up tight. Check freeness of pump parts by rotating driveshaft.

Install propeller shaft shims and thrust plug. Slide propeller shaft and gear into place. Rotate shaft to

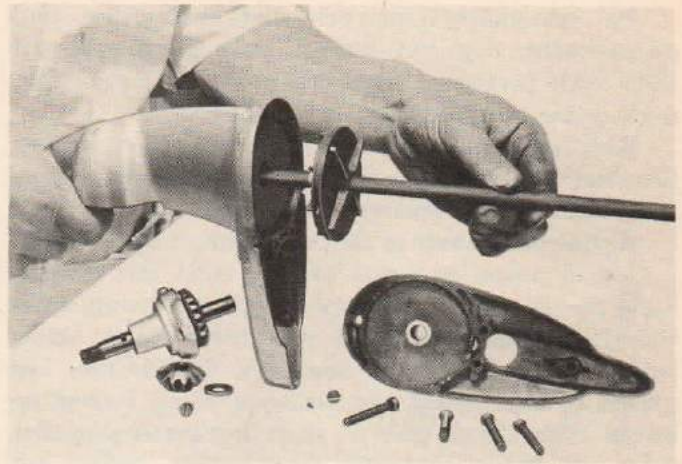

Figure 77

check for gear mesh. Use more or less shims as required. Install gear housing cap after shellacking new gasket to cap. Draw screws up tight. Rotate shaft to check freeness of assembly. (If tight, gasket may have doubled or otherwise gone askew.)

Install propeller clutch hub and clutch washer. Slide clutch ring into propeller hub. Install shear pin and propeller.

### ZEPHYR

**BROKEN HOUSINGS, PROPELLER, PUMP BODIES**—These parts are die cast aluminum alloy and must be replaced if broken. Check all castings carefully for cracks.

To disassemble, remove driveshaft tube screw; then pump body clamp screw. Pull gear housing off with driveshaft and pump.

Remove propeller cotter, nut, spring and propeller wheel.

Remove propeller shear pin and slide off clutch cone.

Clamp gear housing skeg horizontally in copper jawed vise.

Remove 3 pump body screws. Separate upper half of pump body and slide off over driveshaft.

Remove gear housing cap screws and cap. Remove propeller shaft and thrust washer. Remove driveshaft. Drive out driveshaft gear key and thrust washer from gear housing.

Wash all parts. Check grease seal for wear or injury. Replace if necessary.

If either upper or lower piece of gear housing is broken or worn, requiring replacement, remove gear housing screw and pump body to gear housing screw. (This requires a special, heavy T handle screw driver with pilot. See Tool Listing, page 62.)

Replace broken part and reassemble firmly.

Check all bushings, shafts, gears and pump parts for wear and replace as required. For replacing pump parts see instructions under Ranger model.



To reassemble, insert driveshaft in housing. Slip thrust washer over end of shaft, place key in gear and slide shaft into gear engaging key in keyway. Spin shaft to see whether it turns freely.

Slide upper part of pump body into place, making sure that deflector pin is in place in pump body groove. Insert and tighten securely 3 pump body screws.

Again rotate shaft to check whether it turns freely.

Install propeller thrust bearing shim and washer. Slide propeller shaft and gear into place. Rotate shaft slowly to check for proper gear mesh, using shims behind thrust washer as necessary. Shellac new cap gasket to cap. Install cap, drawing 2 cap screws up firmly. Slide clutch cone on shaft and insert propeller drive pin. Install propeller, cone washer, spring, nut and cotter pin.

Remove grease plugs and fill housing with Evinrude Gear Grease.

#### LIGHTFOUR

**BROKEN HOUSINGS, PROPELLER, PUMP BODIES**—These parts are die cast aluminum alloy and must be replaced if broken. Check all castings carefully for cracks.

Remove two gear housing flange stud nuts. This permits removal of housing.

#### PUMP

On this model the pump impeller assembly is on the upper driveshaft. To check this pull shaft downward far enough to inspect. If necessary to replace pump parts, pull upper shaft out entirely. Press shaft out of coupler. Pump parts must be pressed off and on drive coupler. Make sure that these are placed in exact position they originally occupied. Deflector should have  $1/32''$  clearance on each side. Slide assembly back in place.

#### DISASSEMBLE GEAR HOUSING

Remove cotter pin, propeller nut, collar, shear pin and propeller wheel. Remove two gear housing cap screws and gear housing cap. Remove propeller shaft and gear and look for thrust plug on end of propeller shaft. Remove propeller shaft thrust bearing (and plug). Driveshaft gear will drop down. Remove key from lower driveshaft and pull shaft out upwards.

Wash all parts. Check bushings, gears, shafts, grease seals and other parts for wear. Replace those necessary. On this model bushings may be replaced separately, and can be pressed out on an arbor press and installed by using a long threaded bolt and nut. (Figure 78.) The upper grease seal has a retainer ring which must first be removed. To replace grease seals slide them on shaft, push them into place with a tube slipped over the shaft and then push retainer ring back into place with same tube.

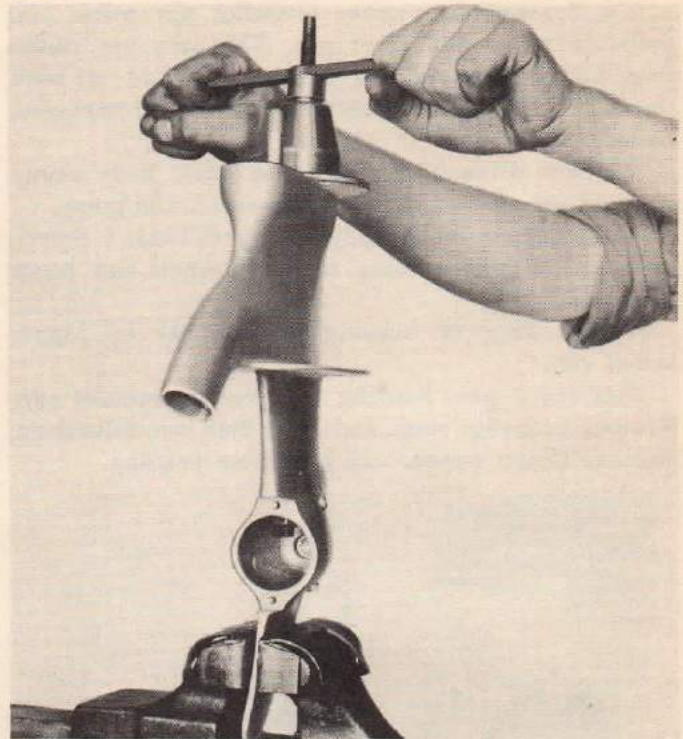

Figure 78

Reassemble, beginning with driveshaft, sliding this up into position. Place key in shaft and place gear on shaft.

Install thrust bearing and plug. Put propeller shaft and gear into thrust bearing and with soft mallet tap shaft, thereby putting thrust bearing assembly into position. Rotate propeller shaft to check gears for mesh, using shims as necessary. On this assembly very little end play is allowed, as spiral bevel gears will hum if meshed too close or too far apart. Set gears so they have just a little clearance, still turn smoothly.

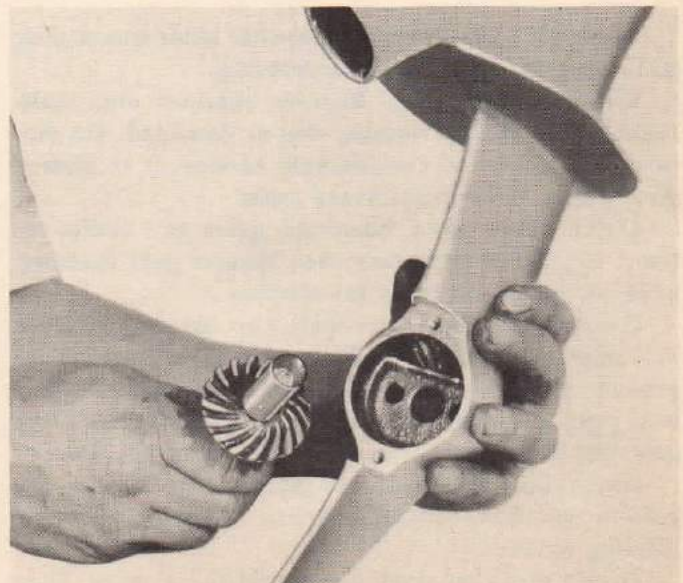

Figure 79



Install cap with gasket shellacked to it, and turn down 2 cap screws securely. Prick punch screws to prevent loosening.

Rotate shaft again to test freeness. If too tight remove cap and press gear housing cap bushing back to give more clearance between cap and gear. Replace cap and when shaft turns freely install propeller wheel shear pin, collar, nut and cotter pin.

Fasten housing to drive housing, replacing 2 nuts securely.

#### SPORTFOUR AND FLEETWIN

**BROKEN HOUSINGS**—This gear housing is sand cast and if broken can sometimes be welded successfully.

To remove gear housing remove two gear housing flange stud nuts.

#### PUMP REPAIRS

With housing removed, the pump impeller is exposed and should be checked for wear. Press on new impeller if necessary.

#### GEAR HOUSING DISASSEMBLY

Remove propeller cotter pin, nut, collar, shear pin and propeller. Remove two cap screws; remove cap and pull out propeller shaft and gear. Remove thrust bearing and plug. Drop out driveshaft gear and key. Pull driveshaft out separately.

#### GREASE SEALS

Proceed as outlined under LIGHTFOUR instructions, page 54.

#### REPLACEMENTS AND REASSEMBLY

Wash all parts. Check all bushings, gears, shafts and other parts for wear and replace those necessary.

To reassemble, first slide in lower driveshaft, insert key in keyway and slide gear on shaft.

Insert thrust bearing and plug, put propeller shaft with gear attached into position and with soft mallet tap on end of propeller shaft to put thrust bearing into place. Rotate propeller shaft to try gears for mesh, using shims back of plug, as required. When gears mesh properly, shellac gasket to gear housing cap and install cap, drawing two cap screws up securely. Prick punch screws to prevent loosening. Again rotate propeller shaft to test freeness. If too tight, add extra gasket to cap.

Install propeller, shear pin, collar, nut and cotter pin.

Remove grease plugs, and fill gear housing with Evinrude Gear Grease through bottom plug. Replace plugs.

Fasten housing to drive housing, replacing two nuts securely.

#### SPEEDITWIN AND SPEEDIFOUR

**BROKEN HOUSINGS**—This gear housing is sand cast and if broken can sometimes be welded successfully.

To remove gear housing remove two gear housing flange stud nuts. Gear housing will drop down with lower driveshaft to which pump impeller is pinned.

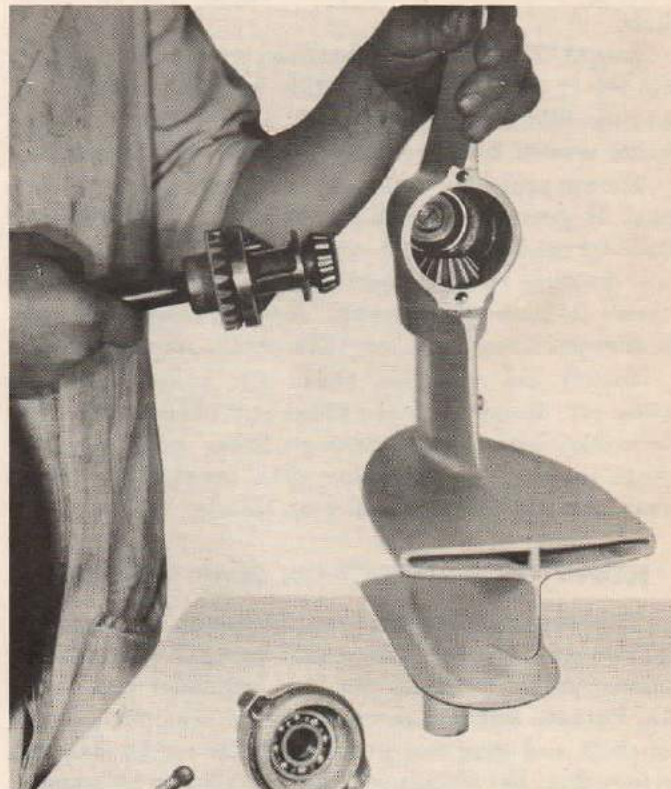

Figure 80

Remove propeller nut cotter pin, nut, collar, shear pin and propeller wheel. Remove two gear housing cap screws and cap in which the ball bearing is located. Remove propeller shaft and gear. Remove driveshaft thrust bearing.

Pull driveshaft upward which will release driveshaft gear. Remove gear, propeller shaft Timken thrust bearing, bronze driveshaft bearing which holds driveshaft and gear in place, propeller shaft thrust washer and driveshaft roller bearing from gear housing.

Wash all parts, making sure that bearings are washed clean of all grit.

Check housing for cracks. This sand casting can sometimes be welded successfully.

Check grease seals. If not in good order, replace by removing sealing washer retainer.

Check all parts including gears for wear or breakage. Check Timken roller bearing cone for wear. If necessary remove from housing, heat housing with torch and tap with hammer to loosen cone. Likewise check driveshaft roller bearing cone. New cones must



be pressed into heated housing. Remove ball bearing assembly from cap by heating and tapping cap. Check bearing for chipped, rusted, or broken ball or looseness indicating wear. Replace if necessary.

Check pump impeller on driveshaft for wear. Replace if necessary.

Reassemble housing, first sliding in driveshaft and slipping roller bearing into place. Install gear on driveshaft.

Install Timken thrust bearing, grease the washer, and lay it against bearing. Slide in driveshaft bronze bearing. Slide in propeller shaft, making sure it enters thrust washer before entering Timken thrust bearing.

Rotate propeller shaft slowly to test for gear clearance. If gears are too close, shim between propeller shaft thrust bearing and washer. Install gear housing cap, drawing two cap screws up tight. Prick punch screws to prevent loosening. Again rotate shaft gear to eliminate end play but with shafts turning freely.

Install the propeller, shear pin, collar, nut and cotter pin. Remove grease plugs and fill housing with Evinrude Gear Grease through lower plug. Replace plugs securely. In attaching gear housing to driveshaft housing draw two nuts up tightly.

### **HEAVY DUTY REDUCTION GEAR HOUSING**

This housing detaches from the motor by removing the two gear housing flange stud nuts. To disassemble remove propeller cotter pin, nut, propeller and shear pin. Remove four cap screws and cap. Pull out propeller shaft and gear and propeller roller thrust bearing and washer. Driveshaft will drop down and by removing cotter pin under gear, gear can be removed. Remove pinion gear key from driveshaft and draw out driveshaft.

Wash all parts.

Check grease seals and replace if not in good order by removing grease seal retainer ring and sealing washer base.

Check all parts, gears, bearings, for wear. Check housing for cracks. This sand-cast part may sometimes be welded successfully.

Check roller bearing cone for wear. Replace if necessary by heating and tapping housing to loosen cone.

If bronze propeller shaft bushing is worn, press out and replace bushing by pressing in new one. If driveshaft bushing is worn, press out and replace with new one.

Reassemble. Slide in driveshaft, place key in position in keyway and slide gear into place. Install new cotter pin under gear.

Slip thrust washer and roller thrust bearing on end of propeller shaft. Slide propeller shaft into position. Rotate propeller shaft to test gear mesh. If too tight, shim behind propeller shaft thrust washer. Install cap, drawing four screws up tight. Prick punch screws to

prevent loosening. Rotate propeller shaft to test end play. If too much end play shim back of propeller shaft gear. Shafts and gears should run free.

Install propeller shear pin, propeller, nut and cotter pin. Remove gear plugs and fill housing with No. 70 oil. See lubrication instructions, page 15.

### **NEW TYPE HEAVY DUTY HOUSING**

Used on heavy duty Lightfour motors, models 4325, 4326, and 4327, numbered 91001 up.

This housing has a ball bearing on the vertical driveshaft, directly above the drive gear. If worn, this bearing should be replaced.

## **SECTION XXIV**

### **RUNNING IN REPAIRED MOTORS BEFORE FINAL TEST ON YOUR TANK**

All motors that have been overhauled in your shop in which pistons, rings or cylinders have been replaced should be thoroughly run in before being operated under their own power. In reassembling, particular care should be taken to line up the motor correctly and to see that it is free.

The best way to run in motors is under belt power. If you have a small speed lathe, fasten the power head of the motor on the bench. Place the flywheel nut on the end of the crankshaft, then place the flywheel nut in the lathe chuck and start the lathe. Place a quantity of lubricating oil in each cylinder through the openings in the cylinders. Let the power head run in this way for 20 to 30 minutes, being sure to give it plenty of oil.

After about a half hour the rings and cylinders will be lapped in sufficiently to permit easy starting. Then assemble the entire motor and run it at half speed on your test tank under its own power until you are satisfied it is perfectly free.

If you do not have a speed lathe but have a drill press you can follow the same procedure by building a rack under the drill press, to which you can fasten the power head.

### **SERVICE BULLETINS**

Our Service Department, from time to time, issues Service Bulletins which are sent to all Evinrude dealers. These bulletins usually deal with some new subject of motor repair, new parts, or improvement in operation.

At nominal cost we supply a serviceable leatherette ring binder in which Service Bulletins may conveniently be filed. We urge all dealers, particularly those who offer service on outboard motors to keep all their Service Bulletins neatly filed in one of these binders, for quick reference and better service.



be pressed into heated housing. Remove ball bearing assembly from cap by heating and tapping cap. Check bearing for chipped, rusted, or broken ball or looseness indicating wear. Replace if necessary.

Check pump impeller on driveshaft for wear. Replace if necessary.

Reassemble housing, first sliding in driveshaft and slipping roller bearing into place. Install gear on driveshaft.

Install Timken thrust bearing, grease the washer, and lay it against bearing. Slide in driveshaft bronze bearing. Slide in propeller shaft, making sure it enters thrust washer before entering Timken thrust bearing.

Rotate propeller shaft slowly to test for gear clearance. If gears are too close, shim between propeller shaft thrust bearing and washer. Install gear housing cap, drawing two cap screws up tight. Prick punch screws to prevent loosening. Again rotate shaft gear to eliminate end play but with shafts turning freely.

Install the propeller, shear pin, collar, nut and cotter pin. Remove grease plugs and fill housing with Evinrude Gear Grease through lower plug. Replace plugs securely. In attaching gear housing to driveshaft housing draw two nuts up tightly.

#### HEAVY DUTY REDUCTION GEAR HOUSING

This housing detaches from the motor by removing the two gear housing flange stud nuts. To disassemble remove propeller cotter pin, nut, propeller and shear pin. Remove four cap screws and cap. Pull out propeller shaft and gear and propeller roller thrust bearing and washer. Driveshaft will drop down and by removing cotter pin under gear, gear can be removed. Remove pinion gear key from driveshaft and draw out driveshaft.

Wash all parts.

Check grease seals and replace if not in good order by removing grease seal retainer ring and sealing washer base.

Check all parts, gears, bearings, for wear. Check housing for cracks. This sand-cast part may sometimes be welded successfully.

Check roller bearing cone for wear. Replace if necessary by heating and tapping housing to loosen cone.

If bronze propeller shaft bushing is worn, press out and replace bushing by pressing in new one. If driveshaft bushing is worn, press out and replace with new one.

Reassemble. Slide in driveshaft, place key in position in keyway and slide gear into place. Install new cotter pin under gear.

Slip thrust washer and roller thrust bearing on end of propeller shaft. Slide propeller shaft into position. Rotate propeller shaft to test gear mesh. If too tight, shim behind propeller shaft thrust washer. Install cap, drawing four screws up tight. Prick punch screws to

prevent loosening. Rotate propeller shaft to test end play. If too much end play shim back of propeller shaft gear. Shafts and gears should run free.

Install propeller shear pin, propeller, nut and cotter pin. Remove gear plugs and fill housing with No. 70 oil. See lubrication instructions, page 15.

#### NEW TYPE HEAVY DUTY HOUSING

Used on heavy duty Lightfour motors, models 4325, 4326, and 4327, numbered 91001 up.

This housing has a ball bearing on the vertical driveshaft, directly above the drive gear. If worn, this bearing should be replaced.

### SECTION XXIV

#### RUNNING IN REPAIRED MOTORS BEFORE FINAL TEST ON YOUR TANK

All motors that have been overhauled in your shop in which pistons, rings or cylinders have been replaced should be thoroughly run in before being operated under their own power. In reassembling, particular care should be taken to line up the motor correctly and to see that it is free.

The best way to run in motors is under belt power. If you have a small speed lathe, fasten the power head of the motor on the bench. Place the flywheel nut on the end of the crankshaft, then place the flywheel nut in the lathe chuck and start the lathe. Place a quantity of lubricating oil in each cylinder through the openings in the cylinders. Let the power head run in this way for 20 to 30 minutes, being sure to give it plenty of oil.

After about a half hour the rings and cylinders will be lapped in sufficiently to permit easy starting. Then assemble the entire motor and run it at half speed on your test tank under its own power until you are satisfied it is perfectly free.

If you do not have a speed lathe but have a drill press you can follow the same procedure by building a rack under the drill press, to which you can fasten the power head.

#### SERVICE BULLETINS

Our Service Department, from time to time, issues Service Bulletins which are sent to all Evinrude dealers. These bulletins usually deal with some new subject of motor repair, new parts, or improvement in operation.

At nominal cost we supply a serviceable leatherette ring binder in which Service Bulletins may conveniently be filed. We urge all dealers, particularly those who offer service on outboard motors to keep all their Service Bulletins neatly filed in one of these binders, for quick reference and better service.



**THE EVINRUDE SERVICE SCHOOL**

Each year for ten years Evinrude has conducted a two weeks' service school of 2 to 3 classes at its plant in Milwaukee. This offers dealers' service men an excellent opportunity for a concentrated course in outboard servicing. Many men have taken advantage of this course in training, and the only cost is that of the student's travel and his maintenance while in Milwaukee. We cooperate in finding suitable, moderate priced living quarters.

Pictured here are some of the recent "graduating" classes, some of which had to be split into two sessions because of the large attendance.



Applicants should write to Evinrude Motors, attention Service Manager.

**WHEN YOU "GET STUCK" ON A REPAIR JOB**

Occasionally a motor will have been subjected to such severe service that it can be repaired only by the most completely equipped service shop or by the factory. When such motors are brought to a service shop with limited facilities, it is best to secure the owner's permission to ship it to the nearest FULLY EQUIPPED service station, or to the factory for overhauling. The advantage of this practice is to give the Evinrude owner better, quicker and complete service, which will benefit not only him but also yourself and the manufacturer.

**OBSTINATE TROUBLES**

Occasionally the best of outboard service men may get stuck on a severe outboard problem for reasons other than lack of repair equipment. Whenever a baffling repair problem like this occurs, write fully to our factory service department, giving all the available facts. We shall endeavor to supply information that will provide a prompt remedy. Better still, send the part, parts, assembly or complete motor to us promptly to enable us to immediately locate and remedy the cause of the difficulty.

We consider such action the best of dealer cooperation, since in new models, all possible troubles are

not discernable until hundreds of motors are run by actual owners. The more rapidly we are able to become conversant with all the service problems with which our dealers are confronted, the more rapidly are we able to extend efficient service to all our valued dealer outlets.

**MOTORS THAT HAVE BEEN SUBMERGED**

Accidents may happen to the most careful person, and it is by no means impossible to drop an outboard motor overboard. Careful boatmen safeguard themselves against such mishaps by tying a length of rope to their motors and tying the other end to the boat. A motor so secured cannot be lost.

A motor that has been submerged is temporarily out of commission. Such a motor must, of course, be



dried out thoroughly before it can be restored to service.

Whatever may have been the cause for the motor's falling off the boat or dock, the one most important thing is to get all the water out and lots of oil into it—**QUICKLY!**

As soon as possible after the motor has been brought to the shore clean and dry it in the following manner:

1. Drain fuel tank; flush thoroughly with clean gasoline.
2. Remove spark plugs.
3. Remove and clean carburetor, fuel line and spark plugs. Make sure all water is removed from these parts.
4. Hold motor in position with carburetor opening in crankcase down, and revolve flywheel slowly to remove water from cylinders and crankcase.
5. Put about two to three tablespoonfuls of oil in each cylinder, through each spark plug hole, and with the spark plugs removed pull the flywheel over rapidly with the starter rope. Repeat this process several times.
6. Reassemble carburetor and gasoline line.
7. Check spark by grounding one wire from magneto to some part of motor, then holding other wire about one-quarter inch from cylinder, pull flywheel over rapidly with starter rope. Reverse above procedure so that both wires will be checked.
8. If no spark or a very faint spark is produced it is an indication that there is some water on the armature base or contact points.
9. Replace magneto and again check for spark as above. If still no spark is apparent, again remove flywheel and check complete magneto. If no spark, or only a weak spark is obtained, place the armature assembly in an oven and dry it thoroughly for 2 to 3 hours at about 250° F. If it still offers no satisfactory spark it should be checked thoroughly and will probably be found to require a new coil.
10. It is advisable to run a submerged motor as soon as possible after submerging as this positively gets rid of any moisture that may still lodge in the cylinders or bearings. Put spark plugs in cylinders, fill fuel tank with proper gasoline mixture and proceed to start motor. Due to the excess oil in cylinders as well as the possibility of some water which may still remain in cylinders it may be necessary to remove and clean the spark plugs once or twice during the process of starting.

### **MOTORS DAMAGED BY SUBMERSION**

If a motor is submerged while running, serious damage may result if a sufficient quantity of water enters the cylinder heads and due to the water being non-compressible, forces the cylinder(s) to break. This or other concealed damage may make it impossible or difficult to "crank" the motor. Such a motor should be disassembled and dried out by immediately and thoroughly washing all parts in clean gasoline.

### **SALT WATER INSTRUCTIONS**

Evinrude and Elto motors are built for use in either fresh or salt water. Yet science has not succeeded in developing any metal which is totally impervious to the corrosive action of salt water. The materials with which your motor is built, and corrosion protected, are commercially "salt water-proof."

A few instructions, easily carried out, will extend the life and satisfactory performance of your motor when it is used in salt water.

If a motor's been out on salt water, it isn't much trouble to flush it with fresh water when you come ashore. The cylinder jackets, water pipes and muffler jacket can all be easily flushed with fresh water by using the flushing nozzle described in our accessory catalog. A motor that is consistently thoroughly flushed with fresh water, will stand up just as well as one used in fresh water.

Filling the gear housing with grease will also force out any water that may have entered housing and give added protection to gear housing parts.

### **CARE OF MOTOR IN COLD WEATHER**

A motor will freeze in cold weather just as the radiator of an automobile will, if not given proper attention. A frozen motor usually means cracked pipes and water jackets.

There is not the slightest danger of a motor freezing while running. But, when a motor is idle, or before storing it away in cold weather, drain the motor by setting it in an upright position and revolving flywheel. This lets the water out of the cylinder jackets and pipes, preventing costly freezing and bursting of parts.

Also fill gear housing with grease to remove any water from housing.

### **STORING THE MOTOR AWAY**

If a motor is not going to be used for a while, don't store it away in a cellar or other place where it will be exposed to dampness or dust. No sportsman would do such a thing with his guns or fishing rods, and there is no reason why a motor should not receive the same care that would be accorded to other personal property of even less value. Dampness and dust may injure the



magneto of your motor, cause deterioration and do other damage almost beyond repair.

When storing motor away, **PUT IT IN A DRY PLACE.** If it has been used in salt water, clean it thoroughly with fresh water, and let it dry before putting it away. Drain the water out of the pipes and cylinder jackets as instructed under "CARE OF MOTOR IN COLD WEATHER." Drain fuel from fuel tank and carburetor. It is also a wise precaution to remove the spark plugs, put a couple of teaspoonfuls of pure lubricating oil into the cylinders, and then revolve the flywheel several times to spread the oil over the cylinder walls before putting the spark plugs back. Pack the gear housing with grease. Wipe the entire motor with a cloth saturated with oil. An exterior film of oil won't hurt any piece of machinery, but dampness and rust **WILL.** When these instructions have been carried out, wrap the motor in a piece of canvas, an old blanket, or in a piece of heavy paper, and store in a dry place.

If these simple instructions are carried out, storing will not injure your motor in the least. Further, it will be ready to run faithfully when you are ready to use it again. It may require a few extra "pulls" because of the excess lubricating oil in the cylinders.

**WHEN READY TO USE IT AGAIN**

If a motor has been idle for some time, or has been stored without the following the instructions—"Storing the Motor Away,"—it is a good plan to squirt a little pure lubricating oil into the cylinders through the spark plug holes. This done, the flywheel should be revolved a few times, to spread the oil around the cylinder walls.

When you take the motor out, polish it up. Be sure that the **GEARS, PROPELLER SHAFT and BEARINGS** are in good condition. Pack the gear case full of new, clean outboard motor grease and reassemble.

Remove the flywheel, and clean the contact points by running a piece of hard paper or cardboard between them. If they are very dirty or rough, use a very fine file to polish them. See that the points open the proper distance (.020). Be sure that flywheel is put back properly and that nut is tight. See page 31.

Clean the screen in the gasoline tank. Clean out the gasoline tank, the gasoline feed pipe and the carburetor.

Mix gasoline and oil in a clean can, and in the right proportion. Fill the tank. See that the fuel is flowing to the carburetor.

**N. O. A. HORSEPOWER**

Time was, when advertised horsepowers of outboard motors were by no means accurate measures of capability. Figures on horsepower were often greatly

exaggerated—the result of unfounded competitive claims.

To end this rather chaotic situation, certain manufacturers signed agreements in 1932 with the National Outboard Association under which they have since abided by a fair, standard method of horsepower determination.

Each model is scientifically tested on the electric dynamometer, under the supervision of an impartial engineer of the Pittsburgh Testing Laboratory. The horsepower figures are then submitted to the National Outboard Association for certification.

During tests, the engine is run at speeds recommended for constant service, so that the horsepower is not the peak performance obtainable, but a measure of the power the owner can expect in ordinary operation on his boat, (deducting for such minor items as muffler, pump and gear loss).

The N. O. A. rating method has proved popular with manufacturers, (all but a few are signatories to the agreement) and apparently the public appreciates having a dependable power standard that proves helpful as a guide during the process of outboard purchase.

**N. O. A. INSURANCE—** Discontinued for the Duration

You are very apt to be questioned about insurance available on outboard motors and boats.

The National Outboard Association in Chicago is in position to obtain excellent low cost insurance coverage for its members, and dues in the association are nominal.

Each motor registration card carries information on insurance, and all inquiries and applications on insurance should be directed to the National Outboard Association, 201 N. Wells Street, Chicago, Illinois.

**FEDERAL REQUIREMENTS**

**NOTE:** No all-embracing definition of what constitutes Federal waters can be given. However, in general it may be said that craft operating on navigable waters in or opening into the Great Lakes, an ocean or gulf, and all navigable waters tributary to such waters, upstream to the first lockless dam, are under Federal supervision and should carry the proper government equipment.

1. A bright white light aft to show all around the horizon. Visible at least 2 miles.\*
2. Combination light in the fore part of boat showing green to starboard and red to port, from right ahead to two points abaft the beam on their respective sides. Visible at least 1 mile.\*
3. A whistle or other sound-producing mechanical appliance capable of producing a blast of 2 seconds or more in duration. (On boats 16 feet or more in length.)



4. A life preserver or ring buoy (or approved cushion) for every person on board.
5. An approved fire extinguisher. Motor boats propelled by outboard motors and not carrying passengers for hire are not required to carry fire extinguishers.
6. Persons who operate any motor boat in a reckless or negligent manner so as to endanger life, limb or property of any person shall be termed guilty of a misdemeanor and, on conviction, shall be punished by a fine not to exceed \$2,000 or by imprisonment for a term not exceeding one year or by both such fine and imprisonment.

\* From sunset to sunrise.

#### BOAT NUMBERS REQUIRED BY DEPARTMENT OF COMMERCE

We quote from the Department Regulations:

1. Application for numbers will be made by the owner or master to the collector of customs of the district in which the owner resides. The owner will then receive full instructions as to the number awarded, how it is to be placed on the vessel, etc.

\* \* \*

3. The following undocumented vessels are required to be numbered:
  1. All boats equipped with permanently fixed engines.
  2. All boats over 16 feet in length equipped with detachable engines.
  3. All boats not more than 16 feet in length equipped with detachable engines as the ordinary means of propulsion.
4. The following undocumented vessels are not required to be numbered:
  1. All boats not exceeding 16 feet in length equipped with detachable engines and falling within the following classes:
    - (a) Rowboats and canoes designed and intended for the use of oars or paddles as the ordinary means of propulsion.
    - (b) Sailboats.
    - (c) Boats designed and used solely for the purpose of racing or operation incident to racing.

Evinrude dealers should maintain adequate stocks of correct boat equipment and accessories.



**LIST OF TOOL BLUEPRINTS AVAILABLE**

MODEL	DESCRIPTION	DRAWING NO.
Lightwin, Lightweight	$\frac{9}{16} \times 15$ " Special Exp. Reamer	1
Lightweight	$\frac{7}{16} \times 13 \frac{1}{2}$ " Special Exp. Reamer	2
Lightwin, Fisherman	Special Reamer and Counter Bore	3
Sportwin, Lightwin, Fisherman, Sport Single, Super Single	$1 \frac{1}{16} \times 12$ " Special Exp. Reamer and Guide Bush	4
Foldlite	$\frac{5}{8} \times 14$ " Special Shell Reamer and Guide Bush	5
All Motors, Lightwin and up	Special Facing Cutter for Gear Housing Caps	6
Foldlite	Spec. Reamer for Gear Housing Bearing	7
Lightfour	$1 \frac{3}{16} \times 20$ " Special Adj. Reamer	8
Lightfour	$\frac{1}{2} \times 25$ " Spec. Adj. Reamer and Guide Bush. for Cr. Case	9
Lightfour	$\frac{5}{8} \times 13 \frac{1}{2}$ " Spec. Adj. Reamer and Guide Bush	10
Lightfour	$\frac{1}{2} \times 13 \frac{1}{2}$ " Spec. Adj. Reamer and Guide Bush	11
Speeditwin, Speedifour, Sr. Quad	$1 \times 18$ " Exp. Reamer and Guide Bush	12
Advanced Speeditwin	$1 \frac{1}{4} \times 15$ " Special Adj. Reamer	13
Sportwin "N", Elto Sr. Quad—1929, Sportfour, Jr. Quad	$1 \frac{1}{16} \times 12$ " Special Exp. Reamer	14
Sportfour, Speeditwin, Super "C", Elto Sr. Quad—1929, Sr. Speedster	$2 \frac{3}{32}$ to $2 \frac{5}{32}$ " Adj. Hand Reamer	15
Sportfour, Speeditwin, Super "C", Elto Sr. Quad—1928, Service Speedster	$2 \frac{1}{32}$ to $2 \frac{3}{32}$ " Adj. Hand Reamer	16
Adv. Speeditwin, Fastwin "H", Speeditwin 10-143-156, Sportfour, Jr. Quad	$\frac{3}{4} \times 16$ " Exp. Reamer and Guide Bush	17
Speeditwin, Speedifour	$1 \frac{3}{16}$ " Exp. Hand Reamer	18
Adv. Speeditwin, Speedifour	.790x16 Spec. Adj. Reamer and Guide Bush	19
Fleetwin, Speeditwin—1927, Lockwood Ace	$\frac{7}{8} \times 18$ " Exp. Reamer	20
Fleetwin, Fastwin "H"	$\frac{5}{8} \times 21$ " Spec. Exp. Reamer	21
Fleetwin, Elto Sr. Quad—1928, Svc. Speedster, Sportfour, Jr. Quad	$\frac{5}{8} \times 18 \frac{7}{8}$ Spec. Shell Reamer and Guide Bush	22
Fleetwin, Sportfour, Jr. Quad	.677x12 Adj. Reamer and Guide Bush	23
Speedifour	Spec. Facing Tool Drive Housing Brg.	24
Speedifour	Spec. Facing Tool Gear Housing Cover	25
Speedifour	Spec. Facing Tool Gear Housing Cover (Ball Brg.)	26
Foldlite	$\frac{3}{8} \times 16$ " Special Reamer	27
Lightwin, Lightweight	$\frac{5}{16}$ " Exp. Hand Reamer	28
Lightwin, Lightweight	Spec. Back Facing Bar and Cutters for Gear Housing	29
Sportwin "N", Foldlite, Lightfour, Lightwin Imp., Sportwin—37-38, Sportsman—35 thru 38	$\frac{7}{16}$ " Hand Exp. Reamer	30
Lightwin, Fisherman, Sport Single, Super Single, Speedibike, Fleetwin "F", Lockwood Ace, Sportfour, Jr. Quad, Lightfour, Lightwin Imp.	$\frac{1}{2}$ " Hand Exp. Reamer	31
Service Twin, Sr. Quad—1928, Svc. Speedster, Fleetwin, Super "A", Sturdtwin, Service "A"	$\frac{9}{16}$ " Hand Exp. Reamer	32
Chief, Sportwin "N", Sportfour, Sr. Quad—1929, Elto Svc. Twin A to H, Elto Svc. Twin J to K, Scout, Pal, Ranger	$\frac{5}{8}$ " Hand Exp. Reamer	33
Sportwin, Fisherman, Lightwin, Lightweight, Sport Single, Super Single, Speedibike	$1 \frac{1}{16}$ " Hand Exp. Reamer	34
Foldlite, Elto Svc. Twin A to H, Lightwin Imperial, Lightfour, Sportwin 37-38, Sportsman 35 thru 38	$\frac{3}{4}$ " Hand Exp. Reamer	35
Service Twin, Service Speedster	$1 \frac{3}{16}$ " Hand Expansion Reamer	36
Fleetwin "F", Lockwood Ace, Elto Svc. Twin J to K, Elto Sr. Quad 1928, Elto Svc. Speedster, Sportfour, Jr. Quad	$\frac{7}{8}$ " Hand Expansion Reamer	37
Sr. Quad 1929, Elto Svc. Twin A to H	$1 \frac{5}{16}$ " Hand Exp. Reamer	38
Speeditwin "T", Elto Svc. Twin J to K, Elto Sr. Quad 1928, Elto Svc. Speedster	1" Hand Exp. Reamer	39
Chief	$1 \frac{1}{16}$ " Hand Expansion Reamer	40
Sportwin "N"	$\frac{29}{64}$ to $\frac{31}{64}$ " Adj. Reamer	41
Service Twin	6° Taper Reamer	42
Jr. Quad 1929, Elto Sr. Quad 1929	$1 \frac{5}{16} \times 17$ " Spec. Adj. Reamer	43
Sr. Quad 1929	Spec. Adj. Reamer and Guide Bush. $1 \frac{1}{16} \times 20$ "	44



**CHART OF CLEARANCES**

MOTOR Part	MATE and CUB		RANGER and PAL		SPORTSMAN and ACE		SPORTWIN & HANDITWIN	
	Max.	Min.	Max.	Min.	Max.	Min.	Max.	Min.
Cylinder and Piston.....	.0022	.0012	.003	.0015	.0035	.002	.0035	.002
Crankshaft—upper .....	.00175	.00075	.0023	.0013	.0023	.0013	.0023	.0013
Crankshaft—lower .....	.00225	.00125	.0028	.0018	.0028	.0018	.0028	.0018
Connecting Rod—Piston ends .....	.0015	.0005	.0011	.0004	.0015	.0008	.0015	.0008
Connecting Rod—Crankshaft ends.....	.0027	.0017	.0025	.0015	.003	.002	.003	.002
Drive Shaft—lower .....	.0015	.0005	.0035	.0015	.0025	.001	.0025	.001
Propeller Shaft in Gear Housing .....	.0025	.001	.003	.001	.0035	.002	.0035	.002
Gear Housing Cap .....	.003	.001	.003	.001	.0035	.002	.0035	.002
Propeller on Shaft .....	.0035	.0015	.0025	.0005	.003	.0015	.003	.0015

MOTOR Part	ZEPHYR		LIGHT- FOUR		SPORT- FOUR		SPEEDI- TWIN		SPEEDI- FOUR	
	Max.	Min.	Max.	Min.	Max.	Min.	Max.	Min.	Max.	Min.
Cylinder and Piston.....	.0025	.001	.0035	.002	.004	.0025	.006	.004	.008	.0065
Crankshaft—upper .....	.0023	.0013	.0024	.0015	.00275	.00175	.00275	.00175	.00275	.00175
Crankshaft—lower .....	.0028	.0018	.0024	.0015	.00275	.00125	.00275	.00125	.0033	.0022
Crankshaft—center .....	.0024	.0015	.0023	.0015	.00275	.00175			.0031	.0022
Crankshaft—width .....	.005	.008	.003	.006	.004	.007			.004	.008
Connecting Rod— Piston ends .....	.0015	.0008	.0015	.0008	.0012	.0005	.003	.002	.003	.002
Connecting Rod— Crankshaft ends .....	.003	.002	.003	.002	.003	.002	Roller	Roller	Roller	Roller
Drive Shaft—upper .....			.004	.0025	.0045	.003	.00525	.00425	.00525	.00425
Drive shaft—lower .....	.003	.001	.0025	.0015	.0035	.0025	.00325	.00225	.00325	.00225
Propeller Shaft in Gear Housing .....	.0035	.0015	.004	.0025	.003	.0015	.00575	.00425	.00575	.00425
Gear Housing Cap .....	.0035	.0015	.0025	.001	.003	.0015	.00475	.00375	.00475	.00375
Propeller on Shaft .....	.002	.0005	.004	.0025	.003	.0015	.00425	.00275	.00425	.00275



**1912-1942 EVINRUDE-ELTO CYLINDER CLEARANCES**

YEAR	MODEL	CYLINDER CASTING NO.	PISTON NO.	MIN. MAX.
1912-28	A & B	A1B	A2B-3	.0015-.0035
1923-29	N-Ns-In-183	A1M-A1N	A2F	.002-.0035
1927	R-Rs	A1T-A1T-1, A1U-A1U-1	A2-K	.002-.0035
1927	T-TS	A1R-A1S-A1S-1	A2J	.003-.0045
1928-30	F-1F-139	A1T-a-A1U-2-110518-110519	100044	.0055-.007
1929-30	H-HL-1H	A1AA-A1AB-110516-110517	A2N	.006-.0075
1928-31	U-UL-1U-143-156-167	A1X-A1Y-110514-110515	100024	.009-.0101
1939-42	Mate and Cub	195503	102323	.0012-.0022
1937	Scout	101913	101963	.0015-.003
1938-39	Ranger	101913	101963	.0015-.003
1940-42	Ranger	195430	101963	.0015-.003
1937-39	Pal	101913	101963	.0015-.003
1940-42	Pal	195430	101963	.0015-.003
1933-34	Sport Single	101373	101861	.0025-.004
1933-34	Super Single	101373	101861	.0025-.004
1935-42	Sportsman	101635-102128-101947-200577	101756	.002-.0035
1936-42	Ace	101801-102017	101756	.002-.0035
1930-31	Fold-Light	100107-100108	100096	.004-.006
1932-33	Sportwin and Fisherman	101152-101153	100904	.0015-.003
1936-42	Sportwin	101827-101828-200120-200121	101757	.002-.0035
1932-33	Fisherman	101152-101153	100481	.004-.0055
1934-39	Fisherman	101772-101773-101979-101980	101860-102103	.0025-.004
1936-37	Service Twin	101152-101153	101861	.0025-.004
1936-42	Handitwin	101825-101826-101922-101923	101757	.002-.0035
1931-32	Lightwin	101152-101153	100481	.004-.0055
1933-42	Lightwin	101152-101153-101772-101773-101979-101980- 102268-102269	101861-102103- 101860	.0025-.004
1932-33	Sturdtwin	102316-102317	100861	.0045-.006
1932-33	Service "A"	102316-102317	100861	.0045-.006
1932-34	Fleetwin	102316-102317	100861	.0045-.006
1932-33	Super "A"	102316-102317	100861	.0045-.006
1939-42	Fleetwin	102316-102317	100861	.0045-.006
1934-36	Lightwin Imp.	101694	101471	.004-.0055
1940-42	Zephyr	275150-275151	200549	.001-.0025
1934-42	Lightfour Imp.	101411-101412-102308-102309	101814-101481- 102102	.002-.0035
1931-38	Sportfour	100509-100510-101579-101580	100513-102102- 100101	.004-.0055
1939-42	Sportfour	200300-200301	102275-200005- 200738	.0025-.004
1931-33	Junior Quad	100509-100510	100513-102101	.004-.0055
1931-42	Speeditwin, Super "C"	100435-100436-101247-101248-102249-102250	100440	.010-.012
1933-39	Speeditwin	101247-101248	101181	.004-.006
1930-42	Speedifour, Speediquad, Senior Quad	101900-101901	100348-200764	.0065-.008
1928	Quad	370-7A-373-7A	HD310	.0025-.004
1929	Quad	100637-100638	100639	.006-.008
1931-32	Big Four, Big Quad	100751	100440	.010-.012
1921-25	Service Twin	307-325-370-373	310	.0025-.004
1926	Service Twin	370-6, 373-6	310-6	.0025-.004
1927-31	Service Twin	370-7A, 373-7A	310-7	.0025-.004
1931	Service Twin Models 358-359	370-8, 373-8	310-8	.0025-.004
1928-31	Service Speedster	370-7A, 373-7A	HD310	.0025-.004
1929-30	High Speed Speedster	HD390-HD391	HD392	.004-.005
1929-31	Lightweight	ID13-ID14	ID9	.0045-.0055
1931-32	Lightweight	101152-101153	100481	.004-.0055
1932-33	Lightweight	101152-101153	101861	.0025-.004
1937	Handifour	101989	101814	.0025-.004
1931	Model 340 Speedster	HD390-HD391	HD392	.004-.005
1931-33	Special Speedster	100637-100638	100639	.006-.008
1930-33	Senior Speedster	100140-100141	100152	.0065-.0075



PISTON RING SPECIFICATIONS

Model Motor	Ring Part No.	No. of Rings Used Ea. Piston	Diameter of Ring	Width of Ring	Lb. Compression Recommended When Compressed	Gap Clearance
39, 44.....	A3H	2	3.25	.5625-.563		.002-.012
46, 71, 77, 82-84, 94, 97, 105, 118.....	A3D	3	2.625	3/32	4 to 7	.008-.012
90.....	A3L	3	2.250	.1240-.1245	4 to 7	.030-.040
92, 106, 137, 143, 156, 177, 305, 306, 322, 323, 329, 340.....	100055	3	2.750	.1240-.1245	6½	.030-.040
102, 114, 140, 145.....	A3R	3	2.375	.1240-.1245	4 to 7	.020-.030
111, 139, 142, 158.....	100077	3	2.109375	.1240-.1245	4 to 7	.020-.030
148, 183, 309, 360.....	100710	2	2.00	.1240-.1245	4 to 7	.030-.040
160, 171, 173, 175.....	100288	3	2.375	.1245-.125	3 to 5 lbs.	.006-.010
161, 169.....	100180	3	2.100	.1245-.125	2½ to 4½	.005-.010
162, 403, 404.....	100372	3	1.750	.1240-.1245	3¾ to 5	.006-.016
174.....	561	3	2.250	.1245-.125	4 lbs.	.005 .010
176.....	SK1291	3	2.375	.1245-.125	3½ to 5½	.006-.016
178, 336, 601, 605, 610, 618, 624, 634, 638, 800, 802, 814, 820, 6000, 6004, 6011-6016, 6018, 6019, 6021-6024, 6026-6029, 6031-6032, 6034-6037, 6039, 6041.....	100489	2	2.750	.1240-.1245	4½ to 7	.006-.016
300, 304, 307, 318, 319, 321, 328, 348, 355.....	HD311	3	2.4987 to 2.49875	.1875	9 to 12	.006-.009
302, 308, 314, 333-335, 344, 700, 704, 715, 721, 728, 732, 7000, 7004, 7008, 7009, 7011-7029.....	100425	3	2.500	.1240-.1245	5½ lbs.	.006-.016
310, 361, 363.....	100194	2	2.500	.1240-.1245	5½ lbs.	.025-.035
337, 354.....	311-6	2	2.4985-2.499	.4061	12 to 15	.006-.009
343, 353.....	311	2	2.086	.4061	11 to 13	.003-.010
358.....	311-8	2	2.500	.4061	12 to 15	.006-.009
401, 402, 407, 409, 411, 413, 426, 428, 432, 434, 436, 438, 442, 444, 446, 448, 460, 462, 464, 466, 468, 470, 472, 474, 476, 478, 483, 484, 900, 902, 912, 914, 916, 918, 920, 924, 928, 4000, 4002, 4004, 4008, 4010, 4012, 4016, 4018, 4020, 4022, 4024, 4026, 4030, 4032, 4092-4099, 4101-4109, 4121-4129, 4131-4133, 4138, 4142-4144, 4148, 4149, 4151-4155, 4161-4169, 4171-4177, 4192-4194, 4196-4198, 4214-4218, 4221-4229, 4251, 4267-4269, 4289, 4291-4295, 4309, 4311-4314, 4337-4339, 4341, 9000, 9004, 9008, 9009, 9011-9019, 9021-9029, 9031-9034.....	100490	2	2.000	.1240-.1245	3½ to 5	.006-.016
418, 420, 422, 424, 430, 450, 456, 904, 4034, 4038, 4335, 4336.....	100862	2	2.250	.1240-.1245	4 to 6	.006-.016
454, 4028, 4042, 4044, 4091, 4111-4119, 4134-4137, 4139, 4145-4147, 4156-4159, 4178, 4180-4191, 4195, 4199, 4200, 4205-4209, 4211-4213, 4219, 4231-4239, 4241-4243, 4245-4249, 4254-4259, 4261, 4262, 4271-4279, 4281-4288, 4296-4299, 4301-4308, 4315-4319, 4321, 4329, 4331-4333, 4346-4349, 4351-4358, 4364-4372.....	101267	2	1.750	.09275-.0928	2¾ to 3¾	.006-.016
610, 631, 642, 804, 826-829, 6008, 6017, 6025, 6033, 8000, 8002-8006.....	100801	2	2.750	.1240-.1245	3 to 5	.006-.016
905, 909-911.....	100643	2	2.750	.1240-.1245	9 to 12	.006-.009
6038, 6042, 6043.....	102188	2	2.750	.1245-.125	7¾ to 9¼	.010-.015
4263, 4264.....	102340	2	1.125	.09275-.09325	1 to 2	.004-.012
4201, 4203, 4252, 4253, 4265, 4266, 4334.....	102025	2	1.375	.09275-.09325	1¼ to 2¼	.004-.009
9035-9038—(1940).....	200006	3	2.000	.124-.1245	4½ to 6	.009-.014
9035-9038 (1941 and '42).....	200739	3	2.000	.1240-.1245	4½ to 6	.009-.014
4359, 4361-4363 (1940).....	200052	2	1.500	.09275-.09325	2 to 3	.005-.010
4359, 4361-4363 (1941 and '42).....	200547	2	1.500	.09275-.09325	2 to 3	.005-.010
7031-7034 (1941 and '42).....	200765	3	2.500	.0930-.0935	3 to 5½	.006-.016
6039, 6041 (1940).....	200206	2	2.750	.1240-.1245	4½ to 7	.006-.016
6039, 6041 (1941 and '42).....	200576	3	2.750	.0930-.0935	4½ to 7	.006-.016
938, 939.....	101805	3	2.000	.09275-.09325	2½ to 3¾	.009-.018
948, 952, 958.....	102175	2	2.126	.1235-.1240	5 to 8	.003-.008
948, 952, 958.....	102182	1	2.125	.1235-.1240	4 to 6½	.003-.008



INDEX

*(The following table contains extremely faint and illegible text, likely representing an index or table of contents for the manual.)*



CRANKSHAFT SIZES

Model Motor	Top Journal	Center Journal	Bottom Journal	Con. Rod Pin	Part No.
46, 77.....	.748-.749		.748-.749	.873-.874	A7B
71.....	.748-.749		.748-.749	.873-.874	A7B-3
94.....	.748-.749		.748-.749	.873-.874	A7B-4
82.....	.748-.749		.748-.749	.873-.874	A7E
97.....	.748-.749		.748-.749	.873-.874	A7E-1
84.....	.8745-.875		.8745-.875	.9975-.998	A7G
44.....	.9355-.936		.9355-.936	.998-.9985	A7H
39.....	.9355-.936		.9355-.936	.998-.9985	A7H-1
83.....	.748-.749		.748-.749	.873-.874	A7J
183.....	.686-.6865		.686-.6865	.624-.6245	A7L-1
92.....	.873-.8735		.873-.8735	.9985-.999	A7M
114, 140, 145.....	.748-.7485		.873-.8735	.8745-.875	A7S
300, 302, 318, 319, 333, 334, 340, 348, 355.....	.81225-.81275		.99975-1.00025	.8745-.87525	HD333
305, 306, 322, 323, 329.....	.93725-.92775	1.06225-1.06275	1.12475-1.12525	.937-.93775	ID-3
309, 360.....	.68725-.68775		.81225-.81275	.687-.68775	ID-10-100
307, 308, 328.....	.87475-.87525	1.06225-1.06275	1.12475-1.12525	.8745-.87525	QD-333
176.....	.9837-.9839		.9975-.9985		SK563
1780300 and UP.....	.99975-1.00025	1.1809-1.1813	1.1809-1.1813	.995-1.000	SK1224
353.....	.7475-.74825		.935-.93575	.8745-.87525	333
343.....	.7475-.74825		.935-.93575	.8745-.87525	333-1
337, 354.....	.7475-.74825		.935-.93575	.8745-.87525	333-6
304, 321, 358.....	.81225-.81275		.99975-1.00025	.8745-.87525	333-8
175.....	.9995-1.000		.9995-1.000	1.062-1.0625	20227
148.....	.686-.6865		.686-.6865	.624-.6245	160011
90, 102, 105, 111, 118, 139, 142, 158.....	.748-.7485		.748-.7485	.873-.8735	160038
106, 137, 143, 156, 177.....	.8370-.8375		.8370-.8375	.8745-.875	160054
161, 169, 174.....	.874-.875		.874-.875	.874-.875	160056
162, 403, 404.....	.686-.6865		.686-.6865	.749-.7495	160079
401, 402, 407, 409, 411, 413, 426, 428, 476, 478, 483, 484, 4016, 4018, 4092*, 4093*, 4094*, 4095*, 4096*, 4121*, 4122*, *Motor Nos. 0001 to 2000, 4097', 4098', 4099', 4101', 4127', 4128', *Motor Nos. 0001 to 0500.....	.68725-.6875		.81225-.8125	.6870-.68775	160097
418, 422, 450, 456, 904, 4034, 4038, 4335, 4336.....	.87475-.875		.99975-1.00	.8745-.875	160136
909-911.....	.93725-.9375		1.12475-1.125	.9370-.93775	160139
420, 424, 430.....	.87475-.875		.99975-1.00	.8745-.875	160143
916.....	.6688-.6693		.6870-.68775	.250-.2515	160148
9120200-up, 9140200-up, 920, 924, 9000, 9004, 9008, 9009, 9011-9019, 9021-9029, 9031-9038.....	.99975-1.00025	.99975-1.0025	1.12475-1.125	.8745-.875	160159
432, 434, 436, 438, 464, 466, 472, 474, 4000, 4002, 4004, 4008, 4010, 4012.....	.6875-.68775		.81225-.8125	.6870-.68775	160175
442, 444, 446, 448, 460, 462, 468, 470, 4020, 4022, 4024, 4026.....	.68725-.6875		.81225-.8125	.68725-.6875	160176
454, 4028, 4119, 4184, 4244, 4284, 4328.....	.68725-.6875		.81225-.8125	.749-.7495	160183
4030, 4032.....	.81225-.8125	.81225-.8125	.81225-.8125	.6870-.6875	160194
4042, 4044, 4111-4118, 4134-4137, 4178-4191, 4199, 4200, 4219, 4231-4243, 4245-4249, 4271-4279, 4281-4283.....	.81225-.8125	.81225-.8125	.81225-.8125	.750-.7505	160195
4091, 4139, 4145-4147, 4195, 4205-4208, 4254-4257, 4285, 4286, 4296-4299, 4301, 4302, 4329, 4331, 4346-4349, 4351, 4352.....	.6872-.6877		.6872-.6877	.7500-.7505	160214
4092#, 4093#, 4095#, 4096#, 4121#, 4122#, #Motor Nos. 2000 and up, 4097*, 4098*, 4099*, 4101*, 4127*, 4128*, *Motor Nos. 0500 and up 4123-4126, 4138, 4142-4144, 4148, 4149, 4151-4155, 4161-4165, 4192, 4194, 4196-4198, 4214-4218, 4221-4229, 4251, 4267-4269, 4289, 4291-4295, 4309, 4311-4314, 4337-4339, 4341.....	.68725-.68775		.81225-.81275	.687-.6875	160224
4156-4159, 4209, 4211-4213, 4258, 4259, 4261, 4262, 4287, 4288, 4303-4308, 4332, 4333, 4353-4358.....	.6872-.6877		.6872-.6877	.7500-.7505	160242
4201, 4203, 4252, 4253, 4265, 4266, 4334.....	.6872-.6877		.6872-.6877	.6250-.6255	160251



**CRANKSHAFT SIZES**

Model Motor	Top Journal	Center Journal	Bottom Journal	Con. Rod Pin	Part No.
4263, 4264, 4342.....	.4685-.4690		.4685-.4690	.4685-.4690	160294
4315' thru 4319', 4321' thru 4327' Motor Nos. 00001 to 2000 and 03001 and up.....	.81235-.81275	.9996-1.0000	.81235-.81275	.7500-.7505	160301
310, 361, 363.....	.99975-1.00025		1.12475-1.125	.8745-.875	190428
160, 171, 173.....	.999-1.000		.999-1.000	1.0615-1.0625	190442
1780001-0299, 314, 335, 336, 344, 700, 704, 715, 721, 728, 732, 7000, 7004.....	.99975-1.00025	1.1809-1.1813	1.1809-1.1813	.8745-.875	190644
601, 605.....	.99975-1.00025		1.24975-1.25	.9995-1.000	190869
6100001 to 0099.....	.99975-1.00025		1.24975-1.25	.9995-1.000	191006
900, 902, 912#, 914#, #Motor Nos. 0001 to 0199.....	.99975-1.00025	.99975-1.0025	1.12475-1.125	.8745-.875	191157
905.....	.93725-.93775		1.12475-1.12525	.937-.93775	191257
800, 802, 814, 820.....	.99975-1.00025	1.1809-1.1813	1.1809-1.1813	.9995-1.000	191521
804, 826, 827.....	.99975-1.00025	1.1809-1.1813	1.1809-1.1813	.9995-1.000	191536
618, 624, 634, 638, 6000, 6004, 6011-6016, 6018, 6019, 6021-6024, 6026-6029, 6031, 6032, 6034-6037, 6039, 6041.....	.99975-1.00025		1.24975-1.25	.9995-1.000	191984
7008, 7009, 7011-7019, 7021-7029, 7031-7034.....	1.000-1.00025	1.1809-1.1813	1.1809-1.1813	.8745-.8750	191985
6100100 and up, 631.....	.99975-1.00025		1.24975-1.25	.9995-1.000	192043
918, 928.....	.5899-.5902		.87475-.875	.6870-.68775	192048
828, 829, 8000, 8002, 80030001 to 00099.....	1.24975-1.25025	1.1809-1.1813	1.1809-1.1813	.9995-1.000	192577
642, 6008, 6017, 6025, 6033.....	.99975-1.00025		1.1809-1.1813	.9995-1.000	192630
4102-4109, 4129, 4131-4133, 4165-4169, 4171-4177.....	.81225-.81275	.81225-.81275	.81225-.81275	.6870-.6880	193154
800300100 and up, 8004, 8006.....	1.24975-1.25025	1.1809-1.1813	1.1809-1.1813	.9995-1.000	194483
6038, 6042, 6043.....	1.2495-1.2500		.9995-1.000	.9980-.99985	195419
4315* thru 4319*, 4321* thru 4327* *Motor Nos. 2001 to 3000.....	.81235-.81275	.9996-1.0000	.81235-.81275	.7500-.7505	200035
4359, 4361, 4362, 4363.....	.6872-.6877	.8746-.8750	.6872-.6877	.7500-.7505	200050
4368, 4369, 4371, 4372.....	.6872-.6877		.6872-.6877	.7500-.7505	200666
4364', 4365', 4366', 4367', 'Motor Nos. 00001 to 10,000.....	.6872-.6877		.6872-.6877	.7500-.7505	200667
4364# thru 4367# #Motor Nos. 10,000 and up.....	.6872-.6877		.6872-.6877	.7500-.7505	200815



**PROPELLER WHEELS**

Codé No. (Found on Propeller)	Model	Part No.	Type Propeller
1	162, 403-405.....	100105	Standard
2	401, 402, 406-408, 411, 444, 1929 Elto Lightweight.....	100745	Standard
3	Fleetwin Models F-FL.....	B28AB	Standard
4	145, 146, Fastwin Models H and 1H and up.....	B28AE	Standard
5	143, 144, 156, 157.....	110501	Standard
6	143, 144, 156, 157, 167, 168, 601, 604.....	100408	Heavy Duty
7	601-604.....	100615	Standard
8	C Racer 610.....	100755	Speed
9	902.....	100633	Standard
10	704-707.....	100580	Standard
12	Four Sixty Racer 804.....	100668	Speed
14	905-907.....	100726	Standard
15	310-313, 361, 900, 901.....	100275	Standard
16	605-608, 618-621, 624-627, 634-641, 6000-6007, 6018, 6019, 6021-6024, 6026-6029, 6031, 6032.....	100596	Standard
17	314, 315, 700-704, 715-717, 718, 721-726, 732, 7008, 7009, 7011-7015, 7021-7029.....	100276	Standard
19	161, 82A, 92A.....	100284	Standard (Alum.)
20	160, 163, 82B, 92B.....	100329	Standard
21	360.....	110576	Standard
22	601.....	100762	Speed
23	704-707.....	100763	Speed
24	802, 803, 808, 809.....	100764	Speed
25	800, 801, 806, 807.....	100791	Speed
26	143, 144, 156, 157.....	110503	Speed
27	800, 801, 806, 807.....	100793	Standard
28	802, 803, 808, 809.....	100792	Standard
30	902, 903.....	100769	Speed
31	310-313, 361.....	100427	Heavy Duty
33	401, 402, 406-408, 411, 444, 1929 Elto Lightweight.....	100765	Weedless
34	161, 169, 82A, 92A.....	100415	Standard (Bronze)
35	160, 163, 171, 82B, 92B.....	100417	Heavy Duty
36	1928 Quad (70,000 to 74,999).....	QK930	Standard
37	1929 Quad (75,000 to 80,000).....	100235	Standard
38	1929 Quad (75,000 to 80,000).....	100268	Speed
40	Four Sixty Racer 804.....	100840	Speed
41	1924 and 1925 Service Twin.....	932	Standard
42	418-420, 422-425, 450-453, 456-459.....	100900	Speed
46	409, 410, 413, 414.....	100917	Standard
47	912-915, 920-927, 9000-9009, 9011-9015, 9021-9029.....	100966	Standard
48	420, 421, 424, 425, 452, 453, 458, 459.....	101002	Standard
50	Four Sixty 826.....	101040	Speed
52	418, 419, 422, 423, 450-453, 456, 457, 4034, 4036.....	100754	Standard
53	605-608, 618-621, 624-627, 634-641, 6000-6007, 6018, 6019, 6021-6024, 6026-6029, 6031, 6032.....	101051	Heavy Duty



**EVINRUDE SERVICE MANUAL**

**PROPELLER WHEELS**

Code No. (Found on Propeller)	Model	Part No.	Type Propeller
54	Sportwin Models N and NS and 183.....	B281-2	Standard
56	Fleetwin, Super "A".....	101070	Heavy Duty
57	Four Sixty 826.....	101071	Speed
58	"C" Racer 642, 643, 6008.....	100700	Speed
59	Four Sixty Racer 804.....	100669	Speed
60	432, 433, 436, 437.....	101136	Standard
61	409, 410, 478, 479, 4016-4019, 4093, 4095, 4122, 4151, 4161-4164, 4214-4217.....	101308	Standard
61C	4227, 4228, 4267, 4268.....	192838	Standard
62	442-444, 4016.....	101229	Standard
62C	442-445.....	192675	Standard (Prot. Clutch)
62C	4020-4027.....	192675	Standard
64	432, 433, 436, 437, 4000-4005, 4008-4013.....	101236	Standard
64A	4006, 4007, 4013, 4014.....	101370	Standard
64B	4006, 4007, 4013, 4014.....	193338	Standard (Prot. Clutch)
65	Four Sixty 828.....	101245	Speed
66	"C" Racer 642.....	101246	Speed
67	143, 144, 156, 167.....	101249	Standard (Bronze)
68	143, 144, 156, 167.....	101250	Heavy Duty (Bronze)
72	481.....	101346	Standard
73	4042-4049.....	101366	Heavy Duty
73A	4219, 4245-4249.....	102116	Heavy Duty
73C	4030-4033, 4050-4057, 4070-4073.....	193543	Heavy Duty
75	4042-4049.....	101478	Standard
75B	4030-4033, 4050-4057, 4070-4073.....	193438	Standard
76	4042, 4043, 4045, 4046-4049, 4111, 4114, 4115, 4118.....	101529	Standard
76A	4042-4049.....	101539	Standard
76B	4219, 4245.....	101971	Standard
78	4121, 4152, 4229, 4251, 4269, 4312, 4341.....	193808	Standard
79	4097-4099, 4101, 4127, 4128.....	193741	Standard
80	4111-4118, 4178-4183, 4185-4190, 4231, 4232, 4237, 4238, 4271-4273, 4277-4279, 4315, 4316, 4322, 4323.....	193742	Standard
81	4091, 4139, 4145, 4205, 4206.....	101636	Standard
82	4102-4109, 4129-4133, 4165-4177.....	193743	Standard
83	4233, 4239, 4283, 4317, 4324.....	193964	Heavy Duty
84	"C" Racer 6017, 6038, 6042, 6043.....	101538	Speed
85A	4146, 4147, 4207, 4208, 4256, 4257, 4301, 4302, 4329, 4331.....	101787	Standard (Alum.)
87	4091, 4139, 4145.....	101721	Standard (Bronze)
88	4148, 4149.....	194163	Standard
92	4146, 4147.....	101823	Standard (Bronze)
93	4156-4159, 4209, 4211-4213, 4262, 4307, 4308, 4332, 4333.....	101820	Standard
94	4221-4223, 4289, 4291, 4292.....	194660	Standard
95	4223, 4292.....	194674	Heavy Duty
96	4201, 4203, 4252, 4253, 4265, 4266, 4334.....	102024	Standard
97	9026-9029, 9031-9038.....	102107	Standard



**EVINRUDE SERVICE MANUAL**

**PROPELLER WHEELS**

Code No. (Found on Propeller)	Model	Part No.	Type Propeller
101	4254, 4255, 4285, 4286.....	102117	Standard
102	4258, 4259, 4287, 4288.....	102121	Standard
103	6034-6037, 6039, 6041.....	102125	Standard
104	7026-7029, 7031-7034.....	102137	Standard
110	4309, 4311, 4313, 4314.....	102226	Standard
110A	4313-4315, 4359, 4361-4363.....	200175	Standard
111	4296-4299, 4346-4349, 4351, 4352, 4364-4367.....	102229	Standard
112	4303-4306, 4353-4358, 4368, 4369, 4371, 4372.....	102230	Standard
113	4263, 4264.....	102285	Standard
116	4315-4318.....	275207	High Speed
117	9026-9029, 9031-9038.....	200278	Heavy Duty
118	9026-9029, 9031-9038.....	200279	High Speed
119	6034-6037, 6039, 6041, 7026-7029, 7031-7034.....	200281	Heavy Duty
121	4190, 4234-4236, 4241-4243, 4247-4249, 4274-4276, 4281, 4282, 4318, 4319, 4321, 4325-4327.....	101906	Heavy Duty
122	4224-4226, 4293-4295, 4337-4339.....	101908	Heavy Duty
		Part No. (Found on Propeller)	
	1921-1922 Service Twin.....	900	Standard
	G & H Service Twin.....	932-6	Standard
	Early J & K Service Twin.....	932-7	Standard
	Lockwood Single.....	1069	Standard
	Lockwood Single.....	1312	Standard
	1928 Quad (70,000 to 74,999).....	100272	Heavy Duty
	1928 Quad (70,000 to 74,999).....	100273	Heavy Duty
	160, 163, 171, 175, 82B, 92B.....	100419	Speed
	310-313, 361.....	100430	Heavy Duty
	1928 Quad (70,000 to 74,999).....	100434	Speed
	1929 Quad (70,000 to 75,000).....	100605	Heavy Duty
	4258, 4259, 4287, 4288.....	102211	Standard (Prot. Clutch)
	4254, 4255, 4285, 4286.....	102212	Standard (Prot. Clutch)
	358 J & K.....	191905	Standard
	478, 479.....	192853	Standard
	62T Lockwood.....	20031	Standard (Alum.)
	62T Lockwood.....	20097	Standard (Bronze)
	72T Lockwood.....	20145	Standard (Alum.)
	72T Lockwood.....	20198	Standard (Bronze)
	Single—Model K.....	B28B	Standard (Alum.)
	Big Twin L, LA, LAT.....	B28F	Standard
	Sportwin Models N and NS and 183.....	B28I-2A	Standard (Bronze)
	Fastwin Model "R".....	B28P	Standard (Alum.)
	Fastwin Model "R".....	B28PA	Standard (Brass)
	Speedtwin Model "T".....	B28TA	Standard
	348—1928-1929 Speedster.....	HK930	Standard
	340.....	IK930	Standard







**MODELS AND YEAR MANUFACTURED**

Model Number	Description	Horsepower	Year Built
	Evinrude Single Cylinder Motor numbers 1 to 9,999	1½ H.P.	1911-1912
	Evinrude Single Cylinder Motor numbers 10,000 to 19,000	2 H.P.	1913
	Evinrude Single Cylinder Motor numbers 20,000 to 49,999	2 H.P.	1914
	Elto Service Twin Motor numbers 1,000 to 1,920	3 H.P.	1921
	Elto Service Twin Motor numbers 1,921 to 6,519	3 H.P.	1922
	Elto Service Twin Motor Models A-B, motor numbers 6,520 to 12,000	3 H.P.	1923
39	Evinrude Single Cylinder Centrifugal Pump	3½ H.P.	1916-1919
44	Evinrude Single Cylinder Motor	3½ H.P.	1916-1923
46	Evinrude Single Cylinder Inboard Motor—Model CC	2 H.P.	1917-1924
71	Evinrude Single Cylinder High Pressure Pump—Model CCV	2 H.P.	1923-1926
77	Evinrude Single Cylinder Motor—Models A-B	2 H.P.	1915-1928
82	Evinrude Twin Cylinder Inboard—Model DD	4-5 H.P.	1916-1926
83	Evinrude Twin Cyl. Inboard (Reverse Gear)—Model DDR	4-5 H.P.	1916-1926
84	Evinrude Big Twin Motor—Models L-LA	4 H.P.	1924-1926
90	Evinrude Fastwin Motor—Model R	4 H.P.	1927
92	Evinrude Speeditwin Motor—Model T	8 H.P.	1927
94	Evinrude Single Cylinder Centrifugal Pump—Model P	2 H.P.	1919-1928
97	Evinrude Twin Cylinder High Pressure Pump—Model DDV	4-5 H.P.	1923-1929
102	Evinrude Fastwin—Model R	4 H.P.	1927
105	Evinrude Twin Cylinder High Pressure Pump—Model RV	4 H.P.	1927
106	Evinrude Speeditwin—Model U	16 H.P.	1928
111	Evinrude Fleetwin—Model F	6 H.P.	1928
114	Evinrude Fastwin—Model H	12 H.P.	1928
118	Evinrude Twin Cylinder High Pressure Pump—Model FV	6 H.P.	1928
137	Evinrude Speeditwin—Model U	20 H.P.	1929
139	Evinrude Fleetwin—Model F	7 H.P.	1929
140	Evinrude Fastwin—Model H	14 H.P.	1929
142	Evinrude Twin Cylinder Centrifugal Pump	6 H.P.	1929
143	Evinrude Speeditwin (Underwater Exhaust)—Model U	20 H.P.	1929-1932
145	Evinrude Fastwin (Underwater Exhaust)—Model H	14 H.P.	1929-1933
148	Evinrude Folding Sportwin—Model 1N	2½ H.P.	1929
156	Evinrude Speeditwin—Utility	22 H.P.	1930-1934
158	Evinrude Fleetwin	7 H.P.	1930
160	Lockwood Chief	11 H.P.	1930
161	Lockwood Ace	7 H.P.	1930
162	O. M. C. Foldlight	2¾ H.P.	1930
169	Lockwood Ace	7 H.P.	1929
171	Lockwood Chief—Model 92B	11 H.P.	1929
173	Lockwood Racing Chief—Model 92BR		1929
174	Lockwood—Model 72T	7 H.P.	1927
175	Lockwood Chief—Model 82B	11 H.P.	1928
176	O.M.C. Speedibee Racer		1930
177	Evinrude Speeditwin Racer		1930
178	O.M.C. Four-Sixty Racer		1930
183	Evinrude Sportwin—Model N	2½ H.P.	1923-1928
300	Elto Service Speedster—Motor Numbers 80,000 to 89,999	7 H.P.	1929
302	Elto High Speed Speedster—Motor Numbers 80,000H to 89,999H	11 H.P.	1929
304	Elto Service Twin—Model J—Motor Numbers 45,000 to 59,999	4 H.P.	1927-1929
305	Elto Service Quad—Motor Numbers 75,000 to 79,999	25 H.P.	1929
306	Elto High Speed Quad—Motor Numbers 75,000H to 79,999H	25 H.P.	1929
307	Elto Service Quad—Motor Numbers 70,000 to 74,999	18 H.P.	1928
308	Elto High Speed Quad—Motor Numbers 70,000H to 74,999H	18 H.P.	1928
309	Elto Lightweight—Motor Numbers 90,000 to 99,999	3½ H.P.	1929



**EVINRUDE SERVICE MANUAL**

**MODELS AND YEAR MANUFACTURED**

Model Number	Description	Horsepower	Year Built
310	Elto Senior Speedster	14 H.P.	1930
314	Elto Quad	30 H.P.	1930
318	Elto Speedster with Rudder—Motor Numbers 80,000 to 89,999	7 H.P.	1929
319	Elto Service Speedster with Underwater Exhaust—Motor Numbers 80,000 to 89,999	7 H.P.	1929
321	Elto Service Twin—Model K—Motor Numbers 45,000 to 59,999	4 H.P.	1927-1929
322	Elto Service Quad—Bronze Rods—Motor Numbers 75,000S to 79,999S	25 H.P.	1929
323	Elto Service Quad—Underwater Exhaust—Motor Numbers 75,000 to 79,999	25 H.P.	1929
329	Elto High Speed Quad—Underwater Exhaust—Motor Numbers 75,000 to 79,999	25 H.P.	1929
333	Elto High Speed Speedster—Underwater Exhaust—Motor Numbers 80,000H to 89,999H	11 H.P.	1929
335	Elto High Speed Quad—50 cu. in.	35 H.P.	1930
336	Elto High Speed Quad—60 cu. in.	40 H.P.	1930
337	Elto Service Twin—Model G—Motor Numbers 30,000 to 39,999	4 H.P.	1926
340	Elto Special Speedster	9 H.P.	1929
343	Elto Service Twin—Models C-D—Motor Numbers 20,001 to 29,999	3 H.P.	1925
344	Elto High Speed Quad—50 cu. in. (Racing Lower Unit)	40 H.P.	1930
348	Elto Service Speedster	7 H.P.	1928-1930
353	Elto Service Twin—Model C—Motor Numbers 12,001 to 20,000	3 H.P.	1924
354	Elto Service Twin—Model H—Motor Numbers 30,000 to 39,999	4 H.P.	1926
355	Elto Service Speedster—Underwater Exhaust—Motor Numbers 60,000 to 69,999	7 H.P.	1928
358	Elto Service Twin	4 H.P.	1931
360	Elto Special Lightweight	3.5 H.P.	1931
361	Elto Senior Speedster—Cord Starter	13.7 H.P.	1933
363	Elto Senior Speedster—Knob Starter	13.7 H.P.	1933
401	Elto Lightweight	4 H.P.	1931
402	Evinrude Lightwin	4 H.P.	1931
403	Evinrude Foldlight	2¾ H.P.	1931
404	Elto Foldlight	2¾ H.P.	1931
407	Evinrude Lightwin	4 H.P.	1932
409	Evinrude Sportwin	4 H.P.	1932
411	Elto Lightweight	4 H.P.	1932
413	Elto Fisherman	4 H.P.	1932-1933
418	Evinrude Fleetwin	11 H.P.	1932
420	Evinrude Sturdtwin	5.8 H.P.	1932-1933
422	Elto Super "A"	11 H.P.	1932
424	Elto Service "A"	5.8 H.P.	1932-1933
426	Evinrude Lightwin—Underwater Exhaust	4 H.P.	1932
428	Elto Lightweight—Underwater Exhaust	4 H.P.	1932
430	Elto Service "A"—Closed Timer	5.8 H.P.	1932
432	Evinrude Sport Single	2.2 H.P.	1933
434	Evinrude Sport Single—Full Reverse	2.2 H.P.	1933
436	Elto Super Single	2.2 H.P.	1933
438	Elto Super Single—Full Reverse	2.2 H.P.	1933
442	Evinrude Lightwin	5.1 H.P.	1933
444	Elto Lightweight	5.1 H.P.	1933
446	Evinrude Lightwin—Full Reverse	5.1 H.P.	1933
448	Elto Lightweight—Full Reverse	5.1 H.P.	1933
450	Evinrude Fleetwin	8.5 H.P.	1933
454	O.M.C. Midget Racer		1933
456	Elto Super "A"	8.5 H.P.	1933
460	Evinrude Lightwin—Propeller Clutch	5.1 H.P.	1933
462	Elto Lightweight—Propeller Clutch	5.1 H.P.	1933
464	Evinrude Sport Single—Propeller Clutch	2.2 H.P.	1933
466	Elto Super Single—Propeller Clutch	2.2 H.P.	1933



**EVINRUDE SERVICE MANUAL**

**MODELS AND YEAR MANUFACTURED**

Model Number	Description	Horsepower	Year Built
468	Evinrude Lightwin—Full Reverse and Propeller Clutch.....	5.1 H.P.	1933
470	Elto Lightweight—Full Reverse and Propeller Clutch.....	5.1 H.P.	1933
472	Evinrude Sport Single (Full Reverse and Propeller Clutch).....	2.2 H.P.	1933
474	Elto Super Single—Full Reverse and Propeller Clutch.....	2.2 H.P.	1933
476	Evinrude Sportwin—Underwater Exhaust.....	4 H.P.	1933
478	Elto Fisherman—Underwater Exhaust.....	4 H.P.	1933
481	All-Electric.....		1933
483	Evinrude Sportwin—Propeller Clutch.....	4 H.P.	1933
484	Elto Fisherman—Propeller Clutch.....	4 H.P.	1933
601	Evinrude Speeditwin.....	25 H.P.	1931
605	Elto Super "C".....	25 H.P.	1931
610	O.M.C. Class "C" Racer.....		1931
618	Evinrude Speeditwin.....	25 H.P.	1932
624	Elto Super "C".....	25 H.P.	1932
631	O.M.C. Class "C" Racer.....		1932
634	Evinrude Speeditwin.....	21.1 H.P.	1933
638	Elto Super "C".....	21.1 H.P.	1933
642	O.M.C. Class "C" Racer.....		1933
700	Elto Senior Quad.....	35 H.P.	1931
704	Evinrude Speedifour.....	35 H.P.	1931
715	Evinrude Speedifour.....	36 H.P.	1932
721	Elto Senior Quad.....	36 H.P.	1932
728	Evinrude Speedifour.....	31.2 H.P.	1933
732	Elto Senior Quad.....	31.2 H.P.	1933
800	Elto Big Quad.....	40 H.P.	1931
802	Evinrude Big Four.....	40 H.P.	1931
804	O.M.C. Four-Sixty Racer.....		1931
814	Evinrude Big Four.....	40 H.P.	1932
820	Elto Big Quad.....	40 H.P.	1932
826	O.M.C. Four-Sixty.....		1932
827	O.M.C. Four-Sixty—Dual Ignition.....		1932
828	O.M.C. Four-Sixty.....		1933
829	O.M.C. Four-Sixty—Dual Ignition.....		1933
900	Elto Junior Quad.....	18 H.P.	1931
902	Evinrude Sport Four.....	18 H.P.	1931
904	O.M.C. Centrifugal Pump.....		1933
905	Elto Special Speedster.....	9 H.P.	1931-1933
909	O.M.C. High Pressure Pump—1½".....		1933
910	O.M.C. High Pressure Pump—1½".....		1931
911	O.M.C. High Pressure Pump—2".....		1933
912	Evinrude Sportfour.....	18 H.P.	1932
914	Elto Junior Quad.....	18 H.P.	1932
916	O.M.C. Speedibike.....		1932
918	O.M.C. Lawn-Boy Power Mower.....		1932
920	Evinrude Sportfour.....	18 H.P.	1933
924	Elto Junior Quad.....	18 H.P.	1933
928	O.M.C. Lawn-Boy Power Mower.....		1933-35
930	O.M.C. Shop-King Work Shop Combination.....		1933
938	Evinrude Lawn-Boy Power Mower.....		1936
948	Evinrude Lawn-Boy Power Mower Model D.....		1937-1938
952	Evinrude Lawn-Boy Power Mower Model D.....		1939-1942
958	Evinrude Lawn-Boy Power Mower Model S.....		1938-1941
4000	Evinrude Sport Single.....	2.2 H.P.	1934



EVINRUDE SERVICE MANUAL

MODELS AND YEAR MANUFACTURED

Model Number	Description	Horsepower	Year Built
4002	Evinrude Sport Single—Aluminum Lower Unit.....	2.2 H.P.	1934
4004	Evinrude Single—Full Reverse.....	2.2 H.P.	1934
4008	Elto Super Single.....	2.2 H.P.	1934
4010	Elto Super Single—Aluminum Lower Unit.....	2.2 H.P.	1934
4012	Elto Super Single—Full Reverse.....	2.2 H.P.	1934
4016	Evinrude Fisherman.....	4 H.P.	1934
4018	Elto Fisherman.....	4 H.P.	1934
4020	Evinrude Lightwin.....	5.1 H.P.	1934
4022	Evinrude Lightwin—Full Reverse.....	5.1 H.P.	1934
4024	Elto Lightwin.....	5.1 H.P.	1934
4026	Elto Lightwin—Full Reverse.....	5.1 H.P.	1934
4028	O.M.C. Midget Racer.....		1934
4029	O.M.C. All-Electric.....		1934-36
4030	Evinrude Lightwin Imperial.....	5.5 H.P.	1934
4032	Elto Lightwin Imperial.....	5.5 H.P.	1934
4034	Evinrude Fleetwin.....	8.5 H.P.	1934
4038	Elto Fleetwin.....	8.5 H.P.	1934
4042	Evinrude Lightfour Imperial.....	9.2 H.P.	1934
4044	Elto Lightfour Imperial.....	9.2 H.P.	1934
4091	Sportsman.....	1.5 H.P.	1935
4092	Evinrude Weedless Fisherman.....	4 H.P.	1935
4093	Evinrude Fisherman.....	4 H.P.	1935
4094	Evinrude Fisherman—5" Longer.....	4 H.P.	1935
4095	Elto Fisherman.....	4 H.P.	1935
4096	Elto Fisherman—5" Longer.....	4 H.P.	1935
4097	Evinrude Lightwin.....	4.6 H.P.	1935
4098	Evinrude Lightwin—5" Longer.....	4.6 H.P.	1935
4099	Elto Lightwin.....	4.6 H.P.	1935
4101	Elto Lightwin—5" Longer.....	4.6 H.P.	1935
4102	Evinrude Lightwin Imperial.....	5 H.P.	1935
4103	Evinrude Lightwin Imperial—5" Longer.....	5 H.P.	1935
4104	Evinrude Lightwin Imperial—Simplex starter.....	5 H.P.	1935
4105	Evinrude Lightwin Imperial—Simplex starter—5" Longer.....	5 H.P.	1935
4106	Elto Lightwin Imperial.....	5 H.P.	1935
4107	Elto Lightwin Imperial—5" Longer.....	5 H.P.	1935
4108	Elto Lightwin Imperial—Simplex Starter.....	5 H.P.	1935
4109	Elto Lightwin Imperial—Simplex Starter—5" Longer.....	5 H.P.	1935
4111	Evinrude Lightfour Imperial.....	9.2 H.P.	1935
4112	Evinrude Lightfour Imperial—5" Longer.....	9.2 H.P.	1935
4113	Evinrude Lightfour Imperial—Simplex Starter.....	9.2 H.P.	1935
4114	Evinrude Lightfour Imperial—Simplex Starter—5" Longer.....	9.2 H.P.	1935
4115	Elto Lightfour Imperial.....	9.2 H.P.	1935
4116	Elto Lightfour Imperial—5" Longer.....	9.2 H.P.	1935
4117	Elto Lightfour Imperial—Simplex Starter.....	9.2 H.P.	1935
4118	Elto Lightfour Imperial—Simplex Starter—5" Longer.....	9.2 H.P.	1935
4119	Midget Racing.....		1935
4121	Elto Weedless Fisherman.....	4 H.P.	1935
4122	Evinrude Fisherman—Full Reverse.....	4 H.P.	1935
4123	Evinrude Fisherman—Propeller Protection Clutch.....	4 H.P.	1935
4124	Evinrude Fisherman—Propeller Protection Clutch—5" Longer.....	4 H.P.	1935
4125	Elto Fisherman—Propeller Protection Clutch.....	4 H.P.	1935
4126	Elto Fisherman—Propeller Protection Clutch—5" Longer.....	4 H.P.	1935
4127	Evinrude Lightwin—15" Longer.....	4.6 H.P.	1935



**MODELS AND YEAR MANUFACTURED**

Model Number	Description	Horsepower	Year Built
4128	Elto Lightwin—15" Longer	4.6 H.P.	1935
4129	Evinrude Lightwin Imperial—15" Longer	5 H.P.	1935
4131	Elto Lightwin Imperial—15" Longer	5 H.P.	1935
4132	Evinrude Lightwin Imperial—Simplex Starter—15" Longer	5 H.P.	1935
4133	Elto Lightwin Imperial—Simplex Starter—15" Longer	5 H.P.	1935
4134	Evinrude Lightfour Imperial—15" Longer	9.2 H.P.	1935
4135	Elto Lightfour Imperial—15" Longer	9.2 H.P.	1935
4136	Evinrude Lightfour Imperial—Simplex Starter—15" Longer	9.2 H.P.	1935
4137	Elto Lightfour Imperial—Simplex Starter—15" Longer	9.2 H.P.	1935
4138	Evinrude Fisherman—Full Reverse, Propeller Protection Clutch	4 H.P.	1935
4139	Sportsman—5" Longer	1.5 H.P.	1935
4142	Evinrude Lightwin Less Underwater Exhaust	4.6 H.P.	1935
4143	Evinrude Fisherman—Less Underwater Exhaust	4 H.P.	1935
4144	Fisherman for Yacht	4 H.P.	1935
4144	Service Twin for Yacht	4.3 H.P.	1936
4145	Elto Ace	1.4 H.P.	1936-1937
4146	Sportsman	1.5 H.P.	1936
4147	Sportsman—5" Longer	1.5 H.P.	1936
4148	Fisherman	4.4 H.P.	1936
4149	Fisherman—5" Longer	4.4 H.P.	1936
4151	Elto Service Twin Reversing	4.3 H.P.	1936
4152	Weedless Fisherman	4.4 H.P.	1936
4153	Lightwin	4.7 H.P.	1936
4154	Lightwin—5" Longer	4.7 H.P.	1936
4155	Lightwin—15" Longer	4.7 H.P.	1936
4156	Sportwin	2.5 H.P.	1936
4157	Sportwin—5" Longer	2.5 H.P.	1936
4158	Elto Handitwin	2.5 H.P.	1936
4159	Elto Handitwin—5" Longer	2.5 H.P.	1936
4161	Elto Service Twin—Magneto	4.3 H.P.	1936
4162	Elto Service Twin—Magneto—5" Longer	4.3 H.P.	1936
4163	Elto Service Twin—Battery	4.3 H.P.	1936
4164	Elto Service Twin—Battery—5" Longer	4.3 H.P.	1936
4165	Lightwin Imperial—Magneto	5 H.P.	1936
4166	Lightwin Imperial—Magneto—5" Longer	5 H.P.	1936
4167	Lightwin Imperial—Magneto—15" Longer	5 H.P.	1936
4168	Lightwin Imperial—Magneto—Simplex Starter	5 H.P.	1936
4169	Lightwin Imperial—Magneto—Simplex Starter—5" Longer	5 H.P.	1936
4171	Lightwin Imperial—Magneto—Simplex Starter—15" Longer	5 H.P.	1936
4172	Lightwin Imperial—Battery	5 H.P.	1936
4173	Lightwin Imperial—Battery—5" Longer	5 H.P.	1936
4174	Lightwin Imperial—Battery—15" Longer	5 H.P.	1936
4175	Lightwin Imperial—Battery—Simplex Starter	5 H.P.	1936
4176	Lightwin Imperial—Battery—Simplex Starter—5" Longer	5 H.P.	1936
4177	Lightwin Imperial—Battery—Simplex Starter—15" Longer	5 H.P.	1936
4178	Lightfour Imperial—Magneto	9.2 H.P.	1936
4179	Lightfour Imperial—Magneto—5" Longer	9.2 H.P.	1936
4180	Lightfour Imperial—Magneto—15" Longer	9.2 H.P.	1936
4181	Lightfour Imperial—Magneto—Simplex Starter	9.2 H.P.	1936
4182	Lightfour Imperial—Magneto—Simplex Starter—5" Longer	9.2 H.P.	1936
4183	Lightfour Imperial—Magneto—Simplex Starter—15" Longer	9.2 H.P.	1936
4184	Midget Racing		1936
4185	Lightfour Imperial—Battery	9.2 H.P.	1936



**EVINRUDE SERVICE MANUAL**  
**MODELS AND YEAR MANUFACTURED**

Model Number	Description	Horsepower	Year Built
4186	Lightfour Imperial—Battery—5" Longer	9.2 H.P.	1936
4187	Lightfour Imperial—Battery—15" Longer	9.2 H.P.	1936
4188	Lightfour Imperial—Battery—Simplex Starter	9.2 H.P.	1936
4189	Lightfour Imperial—Battery—Simplex Starter—5" Longer	9.2 H.P.	1936
4190	Lightfour Imperial Heavy Duty	9.2 H.P.	1936
4191	Lightfour Imperial—Battery—Simplex Starter—15" Longer	9.2 H.P.	1936
4192	Fisherman for Yacht	4.4 H.P.	1936
4192	Fisherman for Yacht	4.4 H.P.	1938
4193	Service Twin—Propeller Protection Clutch	4.3 H.P.	1936
4194	Fisherman—Propeller Protection Clutch	4.4 H.P.	1936
4195	Elto Ace—5" Longer	1.4 H.P.	1936
4196	Lightwin Heavy Duty	4.7 H.P.	1936
4197	Lightwin Heavy Duty—15" Longer	4.7 H.P.	1936
4198	Lightwin Heavy Duty—5" Longer	4.7 H.P.	1936
4199	Lightfour Heavy Duty—15" Longer	9.2 H.P.	1936
4200	Lightfour Heavy Duty—5" Longer	9.2 H.P.	1936
4201	Scout	.9 H.P.	1937
4203	Elto Pal	.9 H.P.	1937
4205	Elto Ace	1.4 H.P.	1937
4206	Elto Ace—5" Longer	1.4 H.P.	1937
4207	Sportsman	1.6 H.P.	1937
4208	Sportsman—5" Longer	1.6 H.P.	1937
4209	Sportwin	2.5 H.P.	1937
4211	Sportwin—5" Longer	2.5 H.P.	1937
4212	Elto Handitwin	2.5 H.P.	1937
4213	Elto Handitwin—5" Longer	2.5 H.P.	1937
4214	Elto Service Twin—Battery	4.3 H.P.	1937
4215	Elto Service Twin—5" Longer—Battery	4.3 H.P.	1937
4216	Elto Service Twin—Magneto	4.3 H.P.	1937
4217	Elto Service Twin—Magneto—5" Longer	4.3 H.P.	1937
4218	Elto Service Twin—Reversing	4.3 H.P.	1937
4219	Elto Handifour	9.2 H.P.	1937
4221	Lightwin	4.7 H.P.	1937
4222	Lightwin—5" Longer	4.7 H.P.	1937
4223	Lightwin—15" Longer	4.7 H.P.	1937
4224	Lightwin—Heavy Duty	4.7 H.P.	1937
4225	Lightwin—Heavy Duty—5" Longer	4.7 H.P.	1937
4226	Lightwin—Heavy Duty—15" Longer	4.7 H.P.	1937
4227	Fisherman	4.4 H.P.	1937
4228	Fisherman—5" Longer	4.4 H.P.	1937
4229	Elto Service Twin—Weedless	4.3 H.P.	1937
4231	Lightfour	9.2 H.P.	1937
4232	Lightfour—5" Longer	9.2 H.P.	1937
4233	Lightfour—15" Longer	9.2 H.P.	1937
4234	Lightfour—Heavy Duty	9.2 H.P.	1937
4235	Lightfour—Heavy Duty—5" Longer	9.2 H.P.	1937
4236	Lightfour—Heavy Duty—15" Longer	9.2 H.P.	1937
4237	Lightfour—Simplex Starter	9.2 H.P.	1937
4238	Lightfour—Simplex Starter—5" Longer	9.2 H.P.	1937
4239	Lightfour—Simplex Starter—15" Longer	9.2 H.P.	1937
4241	Lightfour—Heavy Duty—Simplex Starter	9.2 H.P.	1937
4242	Lightfour—Heavy Duty—Simplex Starter—5" Longer	9.2 H.P.	1937
4243	Lightfour—Heavy Duty—Simplex Starter—15" Longer	9.2 H.P.	1937



**MODELS AND YEAR MANUFACTURED**

Model Number	Description	Horsepower	Year Built
4244	Midget Racing.....		1937
4245	Elto Handifour—5" Longer.....	9.2 H.P.	1937
4246	Elto Handifour—15" Longer.....	9.2 H.P.	1937
4247	Elto Handifour—Heavy Duty.....	9.2 H.P.	1937
4248	Elto Handifour—Heavy Duty—5" Longer.....	9.2 H.P.	1937
4249	Elto Handifour—Heavy Duty—15" Longer.....	9.2 H.P.	1937
4251	Weedless Fisherman.....	4.4 H.P.	1937
4252	Ranger.....	1.1 H.P.	1938
4253	Elto Pal.....	1.1 H.P.	1938
4254	Sportsman—Simplex Starter.....	2.0 H.P.	1938
4255	Sportsman—Simplex Starter—5" Longer.....	2.0 H.P.	1938
4256	Elto Ace.....	1.8 H.P.	1938
4257	Elto Ace—5" Longer.....	1.8 H.P.	1938
4258	Sportwin—Simplex Starter.....	3 H.P.	1938
4259	Sportwin—Simplex Starter—5" Longer.....	3 H.P.	1938
4261	Elto Handitwin.....	2.8 H.P.	1938
4262	Elto Handitwin—5" Longer.....	2.8 H.P.	1938
4263	Mate.....	.5 H.P.	1939-1942
4264	Elto Cub.....	.5 H.P.	1939-1941
4265	Ranger.....	1.1 H.P.	1939-1942
4266	Elto Pal.....	1.1 H.P.	1939-1941
4267	Fisherman.....	4.7 H.P.	1938
4268	Fisherman—5" Longer.....	4.7 H.P.	1938
4269	Weedless Fisherman.....	4.7 H.P.	1938
4271	Lightfour.....	9.2 H.P.	1938
4272	Lightfour—5" Longer.....	9.2 H.P.	1938
4273	Lightfour—15" Longer.....	9.2 H.P.	1938
4274	Lightfour—Heavy Duty.....	9.2 H.P.	1938
4275	Lightfour—Heavy Duty—5" Longer.....	9.2 H.P.	1938
4276	Lightfour—Heavy Duty—15" Longer.....	9.2 H.P.	1938
4277	Lightfour—Simplex Starter.....	9.2 H.P.	1938
4278	Lightfour—Simplex Starter—5" Longer.....	9.2 H.P.	1938
4279	Lightfour—Simplex Starter—15" Longer.....	9.2 H.P.	1938
4281	Lightfour—Simplex Starter—Heavy Duty.....	9.2 H.P.	1938
4282	Lightfour—Simplex Starter—Heavy Duty—5" Longer.....	9.2 H.P.	1938
4283	Lightfour—Simplex Starter—Heavy Duty—15" Longer.....	9.2 H.P.	1938
4284	Midget Racing.....		1938
4285	Sportsman.....	2.0 H.P.	1938
4286	Sportsman—5" Longer.....	2.0 H.P.	1938
4287	Sportwin.....	3.0 H.P.	1938
4288	Sportwin—5" Longer.....	3.0 H.P.	1938
4289	Lightwin.....	4.7 H.P.	1938
4291	Lightwin—5" Longer.....	4.7 H.P.	1938
4292	Lightwin—15" Longer.....	4.7 H.P.	1938
4293	Lightwin—Heavy Duty.....	4.7 H.P.	1938
4294	Lightwin—Heavy Duty—5" Longer.....	4.7 H.P.	1938
4295	Lightwin—Heavy Duty—15" Longer.....	4.7 H.P.	1938
4296	Sportsman.....	2.0 H.P.	1939
4297	Sportsman—5" Longer.....	2.0 H.P.	1939
4298	Sportsman—Simplex Starter.....	2.0 H.P.	1939
4299	Sportsman—Simplex Starter—5" Longer.....	2.0 H.P.	1939
4301	Elto Ace.....	1.8 H.P.	1939
4302	Elto Ace—5" Longer.....	1.8 H.P.	1939



**EVINRUDE SERVICE MANUAL**  
**MODELS AND YEAR MANUFACTURED**

Model Number	Description	Horsepower	Year Built
4303	Sportwin	3.3 H.P.	1939
4304	Sportwin—5" Longer	3.3 H.P.	1939
4305	Sportwin—Simplex Starter	3.3 H.P.	1939
4306	Sportwin—Simplex Starter—5" Longer	3.3 H.P.	1939
4307	Elto Handitwin	3.0 H.P.	1939
4308	Elto Handitwin—5" Longer	3.0 H.P.	1939
4309	Fisherman	5.4 H.P.	1939
4311	Fisherman—5" Longer	5.4 H.P.	1939
4312	Weedless Fisherman	5.4 H.P.	1939
4313	Elto Lightwin	5.0 H.P.	1939-1941
4314	Elto Lightwin—5" Longer	5.0 H.P.	1939-1941
4315	Lightfour	9.7 H.P.	1939-1942
4316	Lightfour—5" Longer	9.7 H.P.	1939
4317	Lightfour—15" Longer	9.7 H.P.	1939
4318	Lightfour—Heavy Duty	9.7 H.P.	1939
4319	Lightfour—Heavy Duty—5" Longer	9.7 H.P.	1939
4321	Lightfour—Heavy Duty—15" Longer	9.7 H.P.	1939
4322	Lightfour—Simplex Starter	9.7 H.P.	1939
4323	Lightfour—Simplex Starter—5" Longer	9.7 H.P.	1939
4324	Lightfour—Simplex Starter—15" Longer	9.7 H.P.	1939
4325	Lightfour—Simplex Starter—Heavy Duty	9.7 H.P.	1939
4326	Lightfour—Simplex Starter—Heavy Duty—5" Longer	9.7 H.P.	1939
4327	Lightfour—Simplex Starter—Heavy Duty—15" Longer	9.7 H.P.	1939
4328	Midget Racing		1939-1941
4329	Elto Ace	1.8 H.P.	Early 1939
4331	Elto Ace—5" Longer	1.8 H.P.	Early 1939
4332	Elto Handitwin	3.0 H.P.	Early 1939
4333	Elto Handitwin—5" Longer	3.0 H.P.	Early 1939
4334	Ranger—Simplex Starter	1.1 H.P.	1939-1942
4335	Elto Fleetwin	8.5 H.P.	1939-1941
4336	Elto Fleetwin—5" Longer	8.5 H.P.	1939-1941
4337	Elto Lightwin—Heavy Duty	5 H.P.	1939-1941
4338	Elto Lightwin—Heavy Duty—5" Longer	5 H.P.	1939-1941
4339	Elto Lightwin—Heavy Duty—15" Longer	5 H.P.	1939-1941
4341	Weedless Lightwin	5 H.P.	1940-1941
4346	Sportsman	2 H.P.	1940
4347	Sportsman—5" Longer	2 H.P.	1940
4348	Sportsman—Simplex Starter	2 H.P.	1940
4349	Sportsman—Simplex Starter—5" Longer	2 H.P.	1940
4351	Ace	1.8 H.P.	1940-1941
4352	Ace—5" Longer	1.8 H.P.	1940-1941
4353	Sportwin	3.3 H.P.	1940
4354	Sportwin—5" Longer	3.3 H.P.	1940
4355	Sportwin—Simplex Starter	3.3 H.P.	1940
4356	Sportwin—Simplex Starter—5" Longer	3.3 H.P.	1940
4357	Handitwin	3 H.P.	1940-1941
4358	Handitwin—5" Longer	3 H.P.	1940-1941
4359	Zephyr	5.4 H.P.	1940-1942
4361	Zephyr—5" Longer	5.4 H.P.	1940-1942
4362	Zephyr—Simplex Starter	5.4 H.P.	1940-1942
4363	Zephyr—Simplex Starter—5" Longer	5.4 H.P.	1940-1942
4364	Sportsman	2 H.P.	1941-1942
4365	Sportsman—5" Longer	2 H.P.	1941-1942



EVINRUDE SERVICE MANUAL

MODELS AND YEAR MANUFACTURED

Model Number	Description	Horsepower	Year Built
4366	Sportsman—Simplex Starter	2 H.P.	1941-1942
4367	Sportsman—Simplex Starter—5" Longer	2 H.P.	1941-1942
4368	Sportwin	3.3 H.P.	1941-1942
4369	Sportwin—5" Longer	3.3 H.P.	1941-1942
4371	Sportwin—Simplex Starter	3.3 H.P.	1941-1942
4372	Sportwin—Simplex Starter—5" Longer	3.3 H.P.	1941-1942
6000	Evinrude Speeditwin	21.1 H.P.	1934
6004	Elto Speeditwin	21.1 H.P.	1934
6008	Racing Speeditwin		1934
6011	Evinrude Speeditwin	21.1 H.P.	1935
6012	Evinrude Speeditwin—5" Longer	21.1 H.P.	1935
6013	Evinrude Speeditwin—Electric Starter	21.1 H.P.	1935
6014	Evinrude Speeditwin—Electric Starter—5" Longer	21.1 H.P.	1935
6015	Elto Speeditwin	21.1 H.P.	1935
6016	Elto Speeditwin—5" Longer	21.1 H.P.	1935
6017	Speeditwin Racing		1935
6018	Elto Speeditwin—Magneto	21.1 H.P.	1936
6019	Elto Speeditwin—Magneto—5" Longer	21.1 H.P.	1936
6021	Elto Speeditwin—Electric Starter	21.1 H.P.	1936
6022	Elto Speeditwin—Electric Starter—5" Longer	21.1 H.P.	1936
6023	Elto Speeditwin—Battery	21.1 H.P.	1936
6024	Elto Speeditwin—Battery—5" Longer	21.1 H.P.	1936
6025	Speeditwin Racing		1936
6026	Elto Speeditwin—Magneto	22.5 H.P.	1937
6027	Elto Speeditwin—Magneto—5" Longer	22.5 H.P.	1937
6028	Elto Speeditwin—Electric Starter	22.5 H.P.	1937
6029	Elto Speeditwin—Electric Starter—5" Longer	22.5 H.P.	1937
6031	Elto Speeditwin—Battery	22.5 H.P.	1937
6032	Elto Speeditwin—Battery—5" Longer	22.5 H.P.	1937
6033	Speeditwin Racing		1937
6034	Elto Speeditwin—Magneto	22.5 H.P.	1938
6035	Speeditwin—Magneto—5" Longer	22.5 H.P.	1938
6036	Elto Speeditwin—Electric Starter	22.5 H.P.	1938
6037	Elto Speeditwin—Electric Starter—5" Longer	22.5 H.P.	1938
6038	Speeditwin Racing		1938
6039	Speeditwin	22.5 H.P.	1939-1942
6041	Speeditwin—5" Longer	22.5 H.P.	1939-1942
6042	Speeditwin Racing		1939-1940
6043	Speeditwin Racing		1941*
7000	Evinrude Speediquad	31.2 H.P.	1934
7004	Elto Speediquad	31.2 H.P.	1934
7008	Evinrude Speediquad	31.2 H.P.	1935
7009	Evinrude Speediquad—5" Longer	31.2 H.P.	1935
7011	Evinrude Speediquad—Electric Starter	31.2 H.P.	1935
7012	Evinrude Speediquad—Electric Starter—5" Longer	31.2 H.P.	1935
7013	Elto Speediquad	31.2 H.P.	1935
7014	Elto Speediquad—5" Longer	31.2 H.P.	1935
7015	Speediquad—Magneto	31.2 H.P.	1936
7016	Speediquad—Magneto—5" Longer	31.2 H.P.	1936
7017	Speediquad—Electric Starter	31.2 H.P.	1936
7018	Speediquad—Electric Starter—5" Longer	31.2 H.P.	1936
7019	Speediquad—Battery	31.2 H.P.	1936
7021	Speediquad—Battery—5" Longer	31.2 H.P.	1936



**EVINRUDE SERVICE MANUAL**  
**MODELS AND YEAR MANUFACTURED**

Model Number	Description	Horsepower	Year Built
7022	Speedifour—Magneto	33.4 H.P.	1937
7023	Speedifour—Magneto—5" Longer	33.4 H.P.	1937
7024	Speedifour—Electric Starter	33.4 H.P.	1937
7025	Speedifour—Electric Starter—5" Longer	33.4 H.P.	1937
7026	Speedifour	33.4 H.P.	1938
7027	Speedifour—5" Longer	33.4 H.P.	1938
7028	Speedifour—Electric Starter	33.4 H.P.	1938
7029	Speedifour—Electric Starter—5" Longer	33.4 H.P.	1938
7031	Speedifour	33.4 H.P.	1939-1942
7032	Speedifour—5" Longer	33.4 H.P.	1939-1942
7033	Speedifour—Electric Starter	33.4 H.P.	1939-1941
7034	Speedifour—Electric Starter—5" Longer	33.4 H.P.	1939-1941
8000	Four—Sixty		1934
8002	Four—Sixty		1935
8003	Four—Sixty		1936
8004	Four—Sixty		1937
8005	Four—Sixty		1938
8006	Four—Sixty		1939-1941
9000	Evinrude Sportfour	16.2 H.P.	1934
9004	Elto Sportfour	16.2 H.P.	1934
9008	Evinrude Sportfour	16.2 H.P.	1935
9009	Evinrude Sportfour—5" Longer	16.2 H.P.	1935
9011	Evinrude Sportfour—Electric Starter	16.2 H.P.	1935
9012	Evinrude Sportfour—Electric Starter—5" Longer	16.2 H.P.	1935
9013	Elto Sportfour	16.2 H.P.	1935
9014	Elto Sportfour—5" Longer	16.2 H.P.	1935
9015	Sportfour—Magneto	16.2 H.P.	1936
9016	Sportfour—Magneto—5" Longer	16.2 H.P.	1936
9017	Sportfour—Electric Starter	16.2 H.P.	1936
9018	Sportfour—Electric Starter—5" Longer	16.2 H.P.	1936
9019	Sportfour—Battery	16.2 H.P.	1936
9021	Sportfour—Battery—5" Longer	16.2 H.P.	1936
9022	Sportfour—Magneto	16.2 H.P.	1937
9023	Sportfour—Magneto—5" Longer	16.2 H.P.	1937
9024	Sportfour—Electric Starter	16.2 H.P.	1937
9025	Sportfour—Electric Starter—5" Longer	16.2 H.P.	1937
9026	Sportfour—Magneto	16.2 H.P.	1938
9027	Sportfour—Magneto—5" Longer	16.2 H.P.	1938
9028	Sportfour—Electric Starter	16.2 H.P.	1938
9029	Sportfour—Electric Starter—5" Longer	16.2 H.P.	1938
9031	Sportfour	16.2 H.P.	1939
9032	Sportfour—5" Longer	16.2 H.P.	1939
9033	Sportfour—Electric Starter	16.2 H.P.	1939
9034	Sportfour—Electric Starter—5" Longer	17.6 H.P.	1939
9035	Sportfour	17.6 H.P.	1940-1942
9036	Sportfour—5" Longer	17.6 H.P.	1940-1942
9037	Sportfour—Simplex Starter	17.6 H.P.	1940-1942
9038	Sportfour—Simplex Starter—5" Longer	17.6 H.P.	1940-1942
9039	Heavy Duty Twin	15 H.P.	1941



# LUBRICATION CHART

## EVINRUDE AND ELTO OUTBOARD MOTORS

**GASOLINE RECOMMENDED**—A good grade of regular gasoline is entirely satisfactory. Ethyl or high test gasoline can be used, but give no added advantage.

**LUBRICANT RECOMMENDED**—Use a high grade oil of S. A. E. No. 30 body such as Mobiloil A, or Mobiloil Marine Heavy Medium for service motors. For racing motors use a high grade oil of S. A. E. No. 60 body such as Mobiloil "B", or Mobiloil Marine Extra Heavy. Quantities shown are for motors already run in. For brand new motors, we recommend using approximately 50% more oil for the first four hours. Keep gear housing filled with Evinrude Gear Grease.

(Names of current models printed in bold type.)

NAME	H.P. or Year	MODEL	Amt. Per Gal. of Gas
<b>ACE</b> (ELTO)	1936 to 1942	4145-4205-4256-4301-4329-4351	1/3 pt.
<b>CUB</b>	1939-42	4264	1/3 pt.
BIG FOUR	1931-32	802-814	1 1/2 pt.
BIG TWIN EVINRUDE	4 H.P.	L-LA	1/2 pt.
FASTWIN	1927	R-RS	3/8 pt.
FASTWIN	1928-33	H-145	1 1/2 pt.
FISHERMAN	1936	4148-4152	1/3 pt.
FISHERMAN	1932 to 1935-37-39	413-4016-4093-4227-4267-4269-4309-4312	1/2 pt.
FLEETWIN	1928-29	F-IF-139	3/8 pt.
FLEETWIN	1932-34	418-450-4034	1 pt.
<b>FLEETWIN</b> (ELTO)	1939-42	<b>4335</b>	1 pt.
FOLDLIGHT	1930-31	<b>162-403-404</b>	3/4 pt.
HANDIFOUR	1937	4219	3/4 pt.
<b>HANDITWIN</b>	1936 to 1942	4158-4212-4261-4307-4332-4357	1/3 pt.
<b>LIGHTFOUR</b>	1934 to 1942	4042-4111-4178-4231-4271-4315	3/4 pt.
LIGHTWEIGHT	1929-30	90000-360	1/2 pt.
LIGHTWEIGHT	1931-32	401-411	1/3 pt.
LIGHTWEIGHT	1933	444	1/2 pt.
LIGHT TWIN (ELTO)	1920-25	A-B-C-D	1/4 pt.
LIGHT TWIN	1926-27-31-35-36	G-H-J-K-402-407-4097-4153	1/3 pt.
LIGHTWIN	1933-34-37-38	442-4020-4221-4289	1/2 pt.
<b>LIGHTWIN</b> (ELTO)	1939-42	4313	1/2 pt.
LIGHTWIN IMPERIAL	1934-35-36	4030-4102-4165	3/8 pt.
LOCKWOOD	1925-27	T	3/4 pt.
LOCKWOOD	1928-30	ACE	3/4 pt.
LOCKWOOD	1928-30	CHIEF	1 pt.
<b>MATE</b>	1939-42	4263	1/3 pt.
<b>PAL</b>	1937 to 1942	4203-4253-4266	1/3 pt.
QUAD	1928-29	70000-79999	1 pt.
QUAD	1930-33	314-700-721-732	1 1/2 pt.
JUNIOR QUAD	1931-33	900-914-924	1 pt.
<b>RANGER</b>	1938 to 1942	4252-4265	1/3 pt.
SCOUT	1937	4201	1/3 pt.
SERVICE "A"	1932-33	424-425	1 pt.

NAME	H.P. or Year	MODEL	Amt. Per Gal. of Gas
SERVICE TWIN	1936	4161	1/3 pt.
SERVICE TWIN	1937	4216	1/2 pt.
SERVICE TWIN ELTO	1928-31	J-K-358-359	1/3 pt.
SINGLE	1934	4000-4008	3/8 pt.
EVINRUDE SINGLE	2 & 3 1/2 H.P.	A	1/2 pt.
SPORT SINGLE	1933	432	3/8 pt.
SUPER SINGLE	1933	436	3/8 pt.
<b>SPEEDIFOUR</b>	1931-33-37 to 1942	704-715-728-7022-7026-7031	1 1/2 pt.
SPEEDIQUAD	1934	7000	1 1/2 pt.
SPEEDIQUAD IMPERIAL	1935-36	7008-7019	1 1/2 pt.
SPEEDITWIN	1927	T	1 1/4 pt.
<b>SPEEDITWIN (Advanced)</b>	1931 to 1942	6000-6011-6018-6026-6034-6039	1 1/2 pt.
SPEEDITWIN (Utility)	1928-31	U-IU-143-156	2 pt.
SPEEDSTER	1928-31	60000-80000-300-340-348	3/4 pt.
SENIOR SPEEDSTER	1930-34	310-312-361-363	3/4 pt.
SPECIAL SPEEDSTER	1931-33	905-907	1 pt.
<b>SPORTFOUR</b>	1931-34-37 to 1942	902-912-920-9000-9022-9026-9031-9035	1 pt.
SPORTFOUR IMPERIAL	1935-36	9008 to 9019	1 pt.
SPORTSMAN	1935 to 1940	4091-4146-4207-4254-4296-4346	1/3 pt.
<b>SPORTSMAN</b>	1941-42	4364	1/3 pt.
SPORTWIN	2 1/2 H.P.	N-IN-183	3/8 pt.
SPORTWIN	1936 to 1940	4156-4209-4258-4303-4353	1/3 pt.
<b>SPORTWIN</b>	1941-42	4368	1/3 pt.
STURDITWIN	1932-33	420-421	1 pt.
SUPER "A"	1932-33	422-456	1 pt.
SUPER "C"	1931-33	605-624-638	1 1/2 pt.
<b>ZEPHYR</b>	1940-42	4359-4363	1/2 pt.
CENTRIFUGAL PUMP	1929-32	1P-2P-142	3/8 pt.
CENTRIFUGAL PUMP	1933 to 1939	904	1 pt.
CENTRIFUGAL PUMP	2 H. P.	"P"	1/2 pt.
HI-PRESSURE PUMP	1926-31	DDV	1/2 pt.
HI-PRESSURE PUMP	1931-34	909-910-911	1 1/2 pt.
HI-PRESSURE PUMP	1935 to 1941	932-933	1 pt.
LAWN BOY	1932-36	918-928-938	1/4 pt.
<b>LAWN BOY</b>	1937 to 1942	948-952-958	None
SPEEDIBIKE	1932-37	916	1/2 pt.



# S H E A R P I N C H A R T

## EVINRUDE AND ELTO OUTBOARD MOTORS

**NOTE:—Part Numbers with respective Diameter, Length and Material Specifications\* are shown in bold type. Models applicable to each size follow in light face type.**

\*Subject to Substitutions

<b>B20C</b> 5/32" 3/4" H. H. Brass 1923-24 Sportwin N-NS	1933 Sport Single 432 1933 Super Single 436	1932-34 Sportfour 912-913-920 to 923-9000 to 9007	<b>131219</b> 1/4" 1-1/8" Mang. Screw Stock 1930 Racing "C" 177-179 1930-31 "4-60" 178-804
<b>B20C-1</b> 5/32" 1-1/4" H. H. Brass 1925-28 Sportwin N-NS-183	1934 Single 4000-4008 1929 Sportwin (Folding) IN 1932-33 Sportwin 409-476	1935-36 Sportfour Imperial 9008 to 9014-9015 to 9021 1937-42 Sportfour 9022 to 9025-9026 to 9029 9031 to 9034-9035 to 9038	<b>132092</b> 3/16" 15/16" 11S-T3 Aluminum 1939-42 Sportswin 4296 to 4299-4346 to 4349-4364-4367 1939-42 Sportwin 4303 to 4306-4353 to 4356-4368-4372
<b>B20C-2</b> 5/32" 1-1/4" Bessemer Rod 1927 Fastwin R-RS to No. 3000	<b>130173</b> 1/4" 1-7/16" 17 St. Aluminum 1929-33 Fastwin IH500 and up and 2H 1928-31 Speeditwin U and IU-2U-143 156	1932-33 Sturditwin 420-421 1932-33 Super "A" 422-423-456 to 459 1931-33 Super "C" 605 to 608-624 to 629-638 to 641	<b>132432</b> 3/16" 1-1/8" H. H. Brass 1936 Fisherman 4148-4149 1935-36 Weedless Fisherman 4092-4121-4152 1937 Service Twin "Weedless" 4229 1938-39 Fisherman "Weedless" 4269-4312 1940 Lightwin "Weedless" 4341 1934-36 Lightfour Imperial 4042 to 4049-4111 to 4118-4178 to 4191 1937-42 Lightfour 4231 to 4239-4271 to 4273-4277 to 4279-4315 to 4327
<b>B20D</b> 7/32" 1" H. H. Brass 1911-27 2 H.P. A Single 1923-26 4 H.P. L-LA	<b>130217</b> 3/16" 1-1/4" 17 St. Aluminum 1928-30 Fleetwin F-IF-139 1930-31 Foldlight 162-403-404	1937 Handifour (Heavy Duty) 4246 1937-42 Lightfour (Heavy Duty) 4241 to 4243-4274 to 4276-4281 to 4283 4318 to 4321 1937-42 Lightwin (Heavy Duty) 4224 to 4226-4293 to 4295-4337 to 4339	<b>132584</b> 3/16" 15/16" No. 3 Sh. Alum. Rod 1936-42 Ace (Elto) 4145-4195 4205-4206-4256-4257-4301-4329-4351 1936-42 Handitwin 4158-4159 4212-4213-4261-4262-4307-4332-4357 1935 Sportsman 4091-4139 1936-37-38 Sportsman 4146 4147-4207-4208-4254 4255-4285-4286 1936-37-38 Sportwin 4155 4157-4209-4211-4258-4259-4287-4288
<b>B20F</b> 3/16" 3/4" Phos. Bronze 1927 Fastwin R-RS No. 3000 up	<b>130321</b> 1/4" 1-1/8" H. H. Brass 1931-32 Big Quad 800-806-820 to 825 1932-34 Fleetwin 418-419-450 to 453-4034 to 4041	1937-42 Lightwin "T" 1928-30 Lockwood "Ace"	<b>132865</b> 5/32" 3/4" No. 3 Sh. Alum. Rod 1937-42 Pal 4203-4253-4266 1937 Scout 4201 1938-42 Ranger 4252-4265
<b>B20H</b> 1/4" 1-3/16" H. H. Brass Single A 3 1/2 H.P.	<b>130503</b> .1819" 1-3/16" Med. Hard Brass 1925-27 Lockwood "T" 1928-30 Lockwood "Ace"	<b>130614</b> .1819" 1-3/16" Tobin Bronze 1928-30 Lockwood "Chief"	<b>133179</b> 1/4" 1-1/8" Monel Metal 1938 Speeditwin 6034 to 6037 1938-42 Speedifour 7026 to 7029-No. 500 and up—7031 to 7034
<b>B20N</b> 1/4" 15/16" St. Aluminum 1928-29 Fastwin H to IH500	<b>130809</b> 7/32" 1" Cold Rid. Steel 1921-25 Lockwood "O. B. Single"	<b>130957</b> 1/4" 1-1/8" 17 St. Aluminum 1930 Speedy Bee 176	<b>133399</b> 1/8" 11/16" No. 3 Sh. Alum. Rod 1939-42 Cub 4264 1939-42 Mate 4263
<b>912</b> 3/16" 1-3/32" H. H. Brass 1921 Service Twin to Motor No. A8362	<b>130975</b> 1/4" 1-1/8" 17 St. Aluminum 1930 Speedy Bee 176	<b>131133</b> 1/4" 1-1/2" Mang. Screw Stock 1932-42 Racing "C" 630-632-642-643-6008-6017-6025-653-6038-6042	
<b>915</b> 7/32" 1-3/32" H. H. Brass 1922-23 Service Twin A-B-C-D	<b>131159</b> 1/4" 1-1/16" H. H. Brass 1931-32 Big Four 802 to 808-814 to 819 1931 Speedifour 704-707 1931 Speeditwin 601-604 1931 Sportfour 902-903	1932-42 "4-60" 826-827-828-829-8000-8002-8003-8004-6005-8C06 1934 36 "X" Racing 8001	
<b>130053</b> 3/16" 15/16" H. H. Brass 1932-35 Fisherman 413-478-4016 to 4019-4093 to 4096	<b>131159</b> 1/4" 1-1/16" H. H. Brass 1931-32 Big Four 802 to 808-814 to 819 1931 Speedifour 704-707 1931 Speeditwin 601-604 1931 Sportfour 902-903	1932-42 "4-60" 826-827-828-829-8000-8002-8003-8004-6005-8C06 1934 36 "X" Racing 8001	
<b>1940-42</b> Zephyr 4359-4363	<b>131159</b> 1/4" 1-1/16" H. H. Brass 1931-32 Big Four 802 to 808-814 to 819 1931 Speedifour 704-707 1931 Speeditwin 601-604 1931 Sportfour 902-903	1932-42 "4-60" 826-827-828-829-8000-8002-8003-8004-6005-8C06 1934 36 "X" Racing 8001	
<b>1937-38</b> Fisherman 4227-4228-4267-4268-4309	<b>131159</b> 1/4" 1-1/16" H. H. Brass 1931-32 Big Four 802 to 808-814 to 819 1931 Speedifour 704-707 1931 Speeditwin 601-604 1931 Sportfour 902-903	1932-42 "4-60" 826-827-828-829-8000-8002-8003-8004-6005-8C06 1934 36 "X" Racing 8001	
<b>1931-34</b> Lightwin 402-406-407-408-442-443-4020 to 4027	<b>131159</b> 1/4" 1-1/16" H. H. Brass 1931-32 Big Four 802 to 808-814 to 819 1931 Speedifour 704-707 1931 Speeditwin 601-604 1931 Sportfour 902-903	1932-42 "4-60" 826-827-828-829-8000-8002-8003-8004-6005-8C06 1934 36 "X" Racing 8001	
<b>1937-38</b> Lightwin 4221-4226-4287-4291-4292	<b>131159</b> 1/4" 1-1/16" H. H. Brass 1931-32 Big Four 802 to 808-814 to 819 1931 Speedifour 704-707 1931 Speeditwin 601-604 1931 Sportfour 902-903	1932-42 "4-60" 826-827-828-829-8000-8002-8003-8004-6005-8C06 1934 36 "X" Racing 8001	
<b>1939-42</b> Lightwin (Elto) 4313	<b>131159</b> 1/4" 1-1/16" H. H. Brass 1931-32 Big Four 802 to 808-814 to 819 1931 Speedifour 704-707 1931 Speeditwin 601-604 1931 Sportfour 902-903	1932-42 "4-60" 826-827-828-829-8000-8002-8003-8004-6005-8C06 1934 36 "X" Racing 8001	
<b>1929-33</b> Lightweight 90000 and up—360 401-405-411-444-445	<b>131159</b> 1/4" 1-1/16" H. H. Brass 1931-32 Big Four 802 to 808-814 to 819 1931 Speedifour 704-707 1931 Speeditwin 601-604 1931 Sportfour 902-903	1932-42 "4-60" 826-827-828-829-8000-8002-8003-8004-6005-8C06 1934 36 "X" Racing 8001	
<b>1933-42</b> Midget Racer 454-4028-4119-4184-4244-4284	<b>131159</b> 1/4" 1-1/16" H. H. Brass 1931-32 Big Four 802 to 808-814 to 819 1931 Speedifour 704-707 1931 Speeditwin 601-604 1931 Sportfour 902-903	1932-42 "4-60" 826-827-828-829-8000-8002-8003-8004-6005-8C06 1934 36 "X" Racing 8001	
<b>1936-37</b> Service Twin 4161 to 4164-4214 to 4218	<b>131159</b> 1/4" 1-1/16" H. H. Brass 1931-32 Big Four 802 to 808-814 to 819 1931 Speedifour 704-707 1931 Speeditwin 601-604 1931 Sportfour 902-903	1932-42 "4-60" 826-827-828-829-8000-8002-8003-8004-6005-8C06 1934 36 "X" Racing 8001	



# SPARK PLUG CHART

## EVINRUDE AND ELTO OUTBOARD MOTORS

Listed below for your convenience is all the spark plug information you need for servicing Evinrude and Elto motors of all models and years. Always order by part number.

Keep a good supply of spare spark plugs on hand at all times. The plug and contact point setting information proves of value to you in servicing motors.

Type	H. P. or Year	Model	Part No.	Name	Plug Setting	Contact Point Setting
ACE (ELTO)	1936 to 42	4145-4205-4256-4301-4329-4351	194404	Ch. * C7	.025 .020	.020
BIGFOUR	1931-32	802-814	194084	Ch. M5	.025 .020	.020
BIG-TWIN	4 H.P.	L-LA	S2301	Ch. 0	.025 .020	.020
EVINRUDE	1939-42	4264	195829, 200092	Ch. J4, H10	.025 .020	.020
CUB	1927	R-RS	S2301	Ch. 0	.025 .020	.020
FASTWIN	1928-29	H-IH	S2301	Ch. 0	.025 .020	.020
FASTWIN	1929-33	2H001-145	190724	Ch. M6	.025 .020	.020
FISHERMAN	1932-39	413-478 4016 4093 4148-4152-4227-4267-4269-4309-4312	190724	Ch. M6	.025 .020	.020
FLEETWIN	1928-29	F I F-139	S2301	Ch. 0	.025 .020	.020
FLEETWIN	1932-34	418-450-4034	190724	Ch. M6	.025 .020	.020
FLEETWIN (ELTO)	1939-42	4335	190724	Ch. M6	.025 .020	.020
FOLDLIGHT	1930 31	162 403	190724	Ch. M6	.025 .020	.020
FOLDLIGHT	1930 31	404 Battery	190724	Ch. M6	.025 .020	.020
HANDIFOUR	1937	4219	194084	Ch. M5	.025 .020	.020
HANDITWIN	1936 to 42	4158-4212-4261-4307-4332-4357	194404	Ch. C7	.025 .020	.020
LIGHTFOUR	1934 to 42	4042-4111-4178-4231-4271-4315	194084	Ch. M5	.025 .020	.020
LIGHTWEIGHT	1929 30	90000-360	190941	AC G8	.025 .009	.009
LIGHTWEIGHT	1931-32	401-411	190724	Ch. M6	.025 .020	.020
LIGHTWEIGHT	1933	444	190724	Ch. M6	.025 .020	.020
LIGHTWIN (ELTO)	1920-25	A B C D	190093	Ch. 7	.025 .009	.009
LIGHTWIN	1926-27	G-H-J-K	190093	Ch. 7	.025 .009	.009
LIGHTWIN	1931-35-36	402-407-4097-4153	190724	Ch. M6	.025 .020	.020
LIGHTWIN	1933-34-37-38	442-4020-4221-4289	190724	Ch. M6	.025 .020	.020
LIGHTWIN (ELTO)	1939-42	4313	190724	Ch. M6	.025 .020	.020
LIGHTWIN	1934-35-36	4030-4102-4165	193542	AC G5	.025 .020	.020
IMPERIAL	1925-27	T	190724	Ch. M6	.025 .020	.020
LOCKWOOD	1928-30	ACE	190724	Ch. M6	.025 .020	.020
LOCKWOOD	1928-30	CHIEF	190724	Ch. M6	.025 .020	.020
MATE	1939-42	4263	195829, 200092	Ch. J4, H10	.025 .020	.020
PAL	1937 to 42	4203-4253-4266	194553, 200092	Ch. J8, H10	.025 .020	.020
QUAD	1928	70000 to 74999	190093	Ch. 7	.025 .009	.009
QUAD	1929	75000 to 79999	IC123	AC G8	.025 .009	.009
QUAD	1930	314-317	194084	Ch. M5	.025 .009	.009
QUAD	1931-33	700-721-732	194084	Ch. M5	.025 .020	.020
JUNIOR QUAD	1931	900	194084	Ch. M5	.025 .009	.009
JUNIOR QUAD	1932-33	914-924	194084	Ch. M5	.025 .020	.020
RANGER	1938 to 42	4252-4265	194553, 200092	Ch. J8, H10	.025 .020	.020
SCOUT	1937	4201	194553	Ch. J8	.025 .020	.020
SERVICE "A"	1932-33	424-425	190724	Ch. M6	.025 .009	.009
SERVICE TWIN	1936	4158	190724	Ch. M6	.025 .020	.020
SERVICE TWIN	1937	4216	190724	Ch. M6	.025 .020	.020
SERVICE TWIN	1928-31	J-K-358-359	190093	Ch. 7	.025 .009	.009
ELTO SINGLE	1934	4000-4008	190724	Ch. M6	.025 .020	.020
EVINRUDE SINGLE	2 & 3 1/2 H. P. A		S2301	Ch. 0	.025 .020	.020
*Champion.						
SPORT SINGLE	1933	432	190724	Ch. * M6	.025 .020	.020
SUPER SINGLE	1933	436	190724	Ch. M6	.025 .020	.020
SPEEDIFOUR	1931-33-37 to 42	704-715-728-7022-7026-7031	194084	Ch. M5	.025 .020	.020
SPEEDIQUAD	1934	7000	194084	Ch. M5	.025 .020	.020
SPEEDIQUAD	1935-36	7008-7019	194094	Ch. M5	.025 .020	.020
IMPERIAL	1927	T	S2301	Ch. 0	.025 .020	.020
SPEEDITWIN	1931 to 42	6000-6011-6018-6026-6034-6039	194084	Ch. M5	.025 .020	.020
ADVANCED	1928-29	U-IU	S2301	Ch. 0	.025 .020	.020
SPEEDITWIN	1929-31	2U-143-156	190093	Ch. 7	.025 .020	.020
SPEEDSTER	1928-31	60000-80000-300-340-348	190093	Ch. 7	.025 .009	.009
SR. SPEEDSTER	1930-32	310-312	190724	Ch. M6	.025 .009	.009
SR. SPEEDSTER	1933	361-363	190724	Ch. M6	.025 .020	.020
SPECIAL	1931-33	905-907	190093	Ch. 7	.025 .009	.009
SPEEDSTER	1931-34-37 to 42	902-912-920-9000-9022-9026-9031-9035	194084	Ch. M5	.025 .020	.020
SPORTFOUR	1935-36	9008-9019	194084	Ch. M5	.025 .020	.020
IMPERIAL	1935 to 38	4091-4146-4207-4254	194141	Ch. J1-15	.025 .020	.020
SPORTSMAN	1939-42	4296-4346-4364	200092	Ch. J8, H10	.025 .020	.020
SPORTSMAN	2 1/2 H. P.	N-IN-183	S2301	Ch. 0	.025 .020	.020
SPORTWIN	1936-38	4156-4209-4258	194141	Ch. J1-15	.025 .020	.020
SPORTWIN	1939-42	4303-4353-4368	200092	Ch. J8, H10	.025 .020	.020
STURDITWIN	1932-33	420-421	190724	Ch. M6	.025 .020	.020
SUPER "A"	1932-33	422-456	190724	Ch. M6	.025 .020	.020
SUPER "C"	1931-33	605-624-638	194084	Ch. M5	.025 .020	.020
ZEPHYR	1940-42	4359	200322	Ch. J10	.025 .020	.020
CENTRIFUGAL PUMP	2 H. P.	P	S2301	Ch. 0	.025 .020	.020
CENTRIFUGAL PUMP	1929	IP	S2301	Ch. 0	.025 .020	.020
CENTRIFUGAL PUMP	1930 32	2P-142	190093	Ch. 7	.025 .020	.020
CENTRIFUGAL PUMP	1933-38	904	190724	Ch. M6	.025 .020	.020
HI-PRESSURE PUMP	1926-31	DDV	S2301	Ch. 0	.025 .020	.020
HI-PRESSURE PUMP	1931-34	909-910-911	190724	Ch. M6	.025 .020	.020
HI-PRESSURE PUMP	1935 to 42	932-933	194084	Ch. M5	.025 .020	.020
LAWNBOY	1932-36	918-928-938	192197	AC-G4 1/2	.025 .020	.020
LAWNBOY	1937	948	190093	Ch. 7	.025 .020	.020
LAWNBOY	1938 to 42	948-952-958	195413	Ch. J8	.030 .020	.020
SPEEDBIKE	1932-37	916	190724	Ch. M6	.025 .020	.020



# Evinrude RANGER

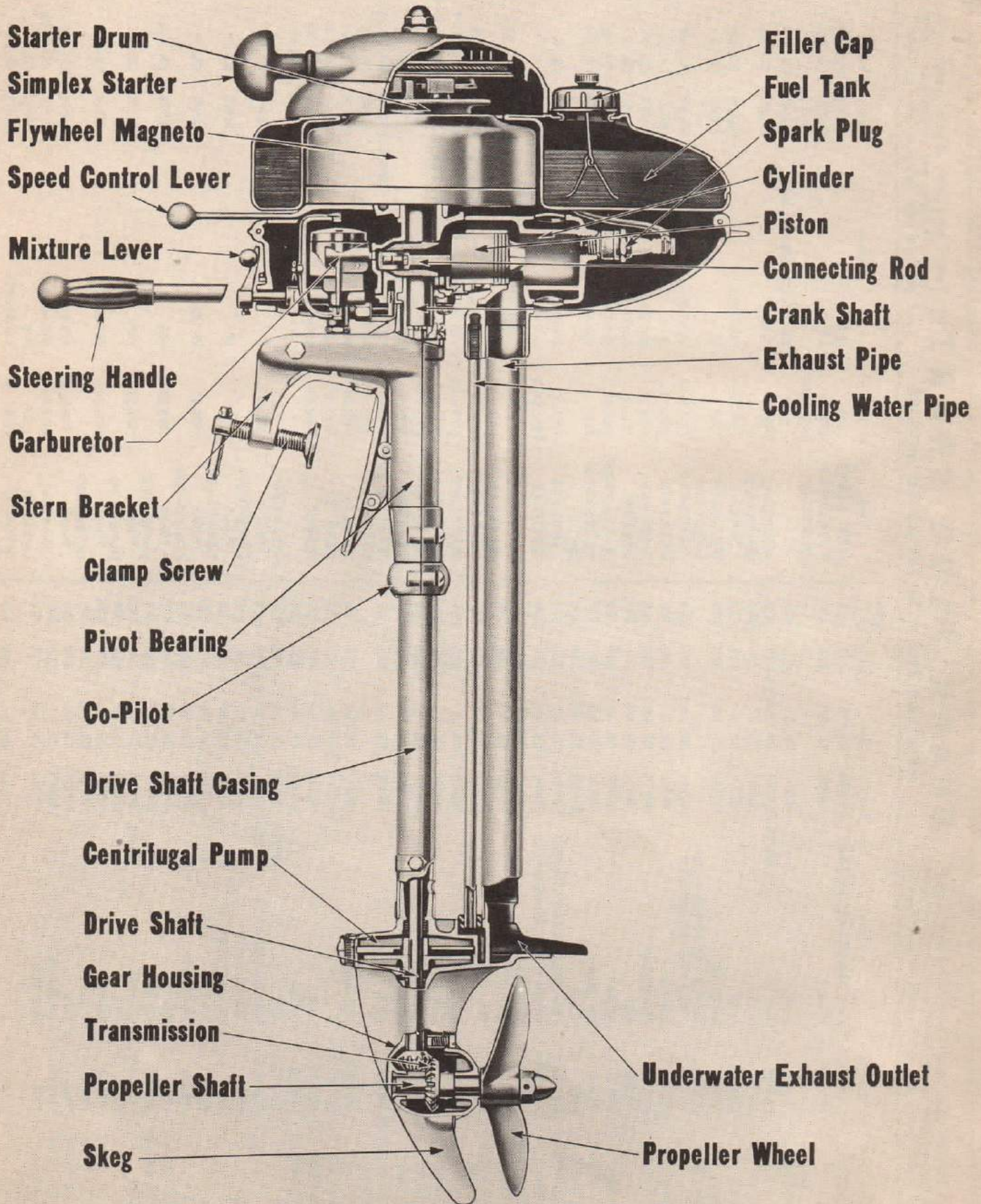



# Evinrude SPORTSMAN

# Evinrude SPORTWIN

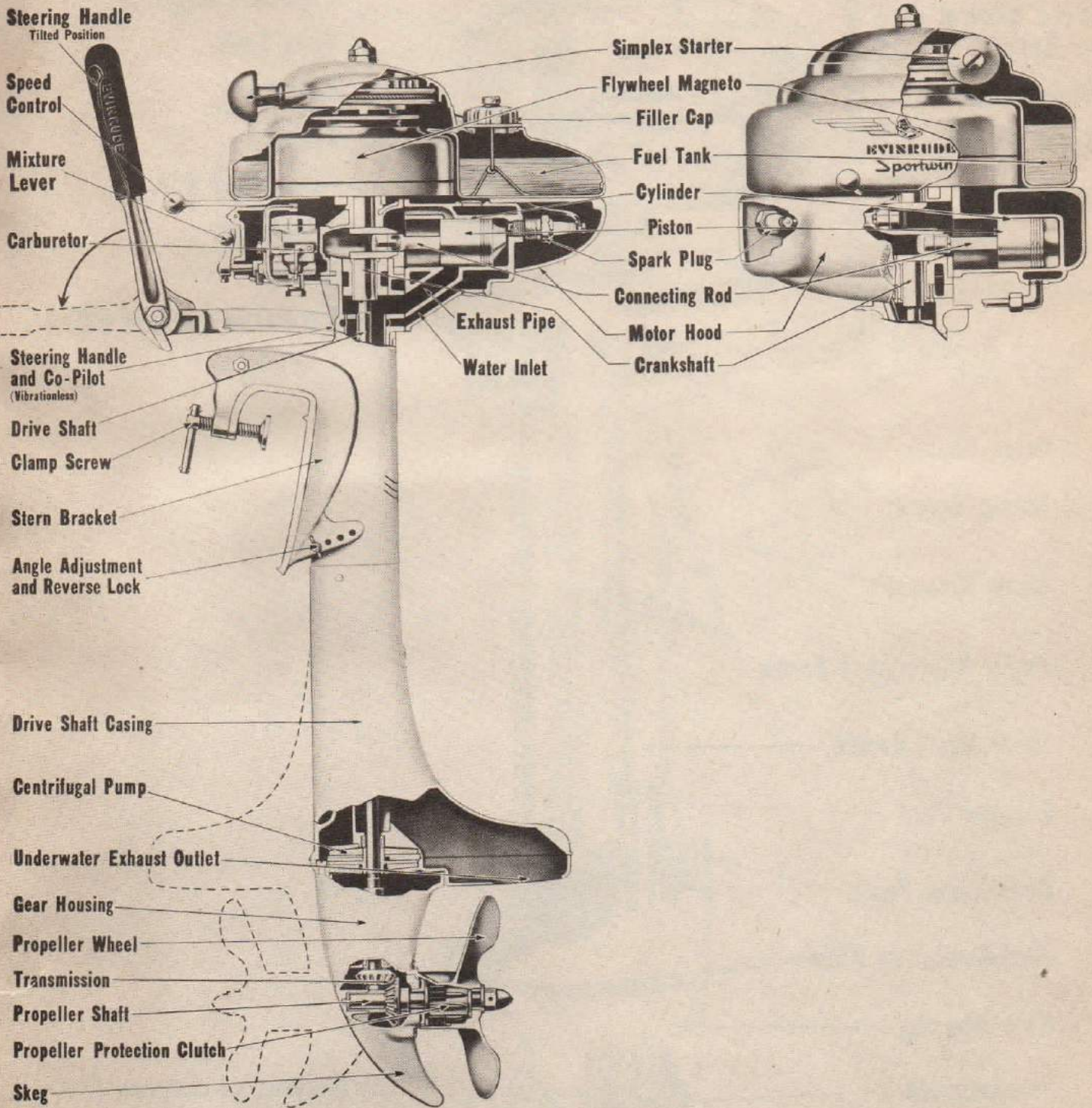



# Evinrude ZEPHYR

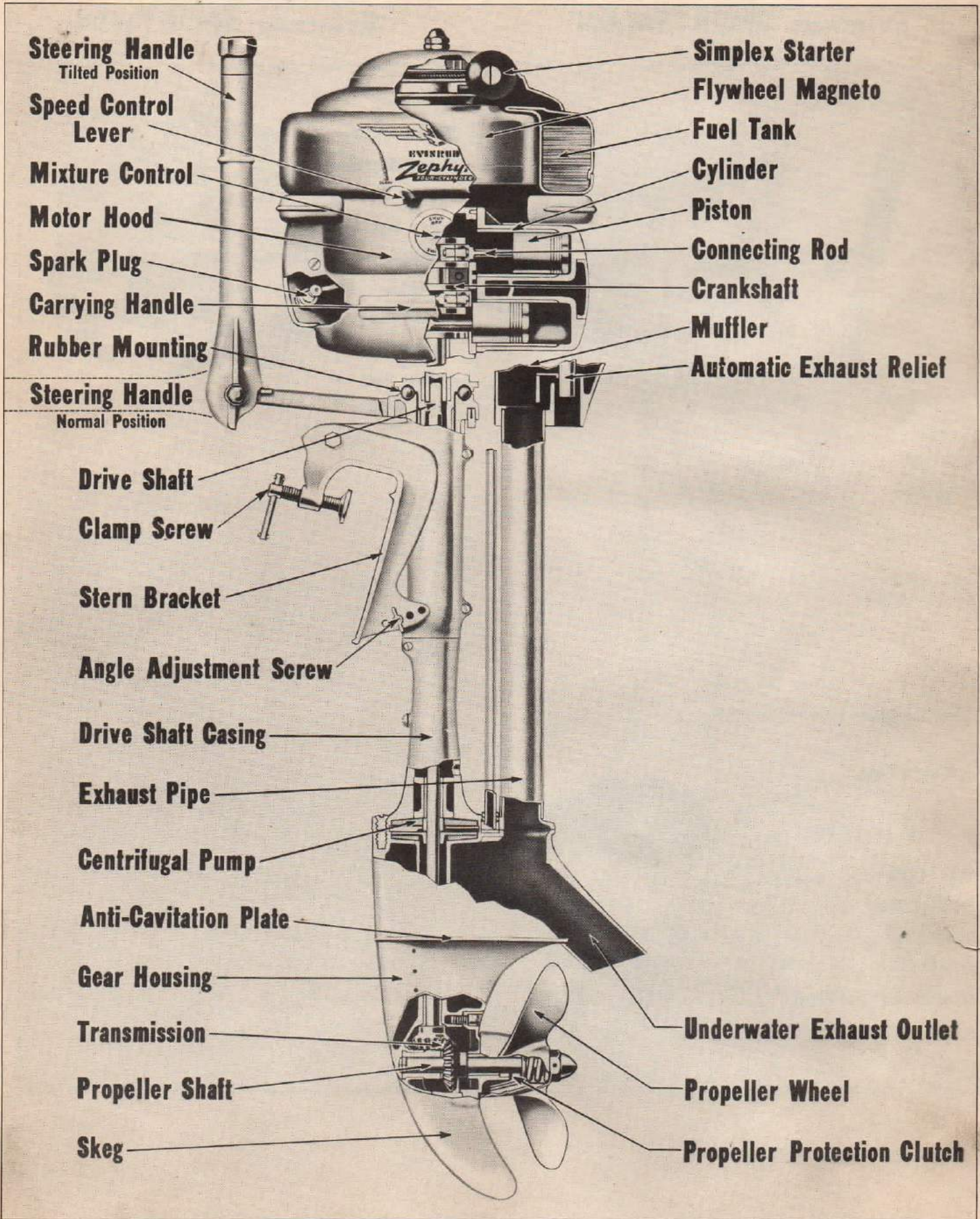



# EVINRUDE-ELTO

## SERVICE BULLETIN

EVINRUDE MOTORS  
Milwaukee, Wisconsin

2-20-42

NUMBER 6

### SUGGESTED EVINRUDE TRADE-IN ALLOWANCE SCHEDULE FOR 1942

YEAR & MODEL	MOTOR SERIAL NUMBER	SUGGESTED TRADE-IN VALUE	ORIGINAL LIST PRICE	BORE	STROKE	H. P.	SPARK PLUG
1920-28 "A" & "B" SINGLE	103800 to 130000	\$ 3.00 to \$12.50	\$110.00	2-5/8	2-1/2	2	Champ. 0
1923-26 "N" - "NS" SPORTWIN	1500 to 10000	3.00 to 10.00	145.00	2	1-1/2	2	0
1926-27 "N" - "NS" SPORTWIN	10500 to 14750	5.00 to 10.00	155.00	2	1-1/2	2-1/2	0
1927 "R" - "RS" FASTWIN	1 to 4429	5.00 to 10.00	165.00	2-1/4	2	4	0
1927 "T" - "TS" SPEEDITWIN	1 to 2712	5.00 to 10.00	215.00	2-3/4	2-1/2	8	0
1928 "F" FLEETWIN	F1001 to F4000	5.00 to 10.00	150.00	2-7/64	2	6	0
1928 "H" FASTWIN	H1001 to H2500	5.00 to 10.00	170.00	2-3/8	2-1/4	12	0
1928 "U" SPEEDITWIN	U1001 to U5200	7.50 to 15.00	210.00	2-3/4	2-1/2	16	0
1929 "IN" SPORTWIN	1N001 to 2N001	7.50 to 15.00	145.00	2	1-1/2	2-1/2	0
1929 "1F"-"4F" FLEETWIN	1F001 to 4F300	7.50 to 15.00	150.00	2-7/64	2	6	0
1929 "1H"-"13H" FASTWIN	1H001 to 13H250	12.50 to 20.00	170.00	2-3/8	2-1/4	14	0
1929 "1U"-"15U" SPEEDITWIN	1U001 to 15U000	12.50 to 20.00	210.00	2-3/4	2-1/2	20	7
1930 FLEETWIN	1390001 and up	7.50 to 15.00	155.00	2-7/8	2	7	0
1930-31-32-33 FASTWIN	1450001 and up	12.50 to 35.00	190.00	2-3/8	2-1/2	14	M6
1930 SPEEDITWIN	1430001 and up	25.00 to 40.00	220.00	2-3/4	2-1/2	20	7
MATE							
1939 MATE	426300001 to 426305000	\$10.00 to \$15.00	\$ 34.50	1-1/8	1	.5	J4
1940 MATE	426303001 and up	15.00 to 20.00	29.95	1-1/8	1	.5	H10
1941 MATE	426303001 and up	17.50 to 22.50	29.95	1-1/8	1	.5	H10
SCOUT							
1937 SCOUT	420100001 and up	\$ 7.50 to \$12.50	\$ 45.00	1-3/8	1-3/8	.9	J8
RANGER							
1938 RANGER	425200001 and up	\$12.50 to \$20.00	\$ 47.50	1-3/8	1-3/8	1.1	J8
1939 RANGER	426500001 to 426504000	15.00 to 25.00	47.50	1-3/8	1-3/8	1.1	J8
1940 RANGER	426504001 and up	20.00 to 30.00	47.50	1-3/8	1-3/8	1.1	H10
1941 RANGER	426504001 and up	22.50 to 30.00	47.50	1-3/8	1-3/8	1.1	H10
SPORT SINGLE							
1933 SPORT SINGLE	4320001 and up	\$ 7.50 to \$15.00	\$ 69.75	2	1-5/8	2.2	M6
1934 SPORT SINGLE	40000001 and up	10.00 to 20.00	79.50	2	1-5/8	2.2	M6
1934 SPORT SINGLE	40020001 and up	15.00 to 25.00	79.50	2	1-5/8	2.2	M6
SPORTSMAN							
1935 SPORTSMAN	40910001 and up	\$ 7.50 to \$12.50	\$ 55.00	1-3/4	1-35/64	1.5	J1-15
1936 SPORTSMAN	41460001 and up	10.00 to 15.00	55.00	1-3/4	1-35/64	1.5	J1-15
1937 SPORTSMAN	42070001 and up	15.00 to 20.00	59.50	1-3/4	1-35/64	1.6	J1-15
1938 SPORTSMAN	42650001 and up	20.00 to 27.50	59.50	1-3/4	1-35/64	2.0	J1-15
1939 SPORTSMAN	42960001 and up	25.00 to 32.50	59.50	1-3/4	1-35/64	2.0	J8
1940 SPORTSMAN	43460001 and up	30.00 to 37.50	59.50	1-3/4	1-35/64	2.0	H10
1941 SPORTSMAN	436400001 and up	35.00 to 42.50	65.50	1-3/4	1-35/64	2.0	H10
2-3/4 H.P. FOLDLIGHT							
1930 FOLDLIGHT	1620001 and up	\$ 7.50 to \$15.00	\$145.00	1-3/4	1-5/8	2-3/4	M6
1931 FOLDLIGHT	4030001 and up	10.00 to 20.00	125.00	1-3/4	1-5/8	2-3/4	M6
SPORTWIN							
1931 SPECIAL SPORTWIN	1830001	\$ 7.50 to \$10.00	\$ 87.50	2	1-1/2	2-1/2	0
1932 SPORTWIN	4090001 and up	7.50 to 10.00	87.75	2	1-5/8	4	M6
1933 SPORTWIN	4093500 and up	10.00 to 15.00	82.75	2	1-5/8	4	M6
1936 SPORTWIN	41560001 and up	15.00 to 30.00	77.00	1-3/4	1-3/8	2.5	J1-15
1937 SPORTWIN	42090001 and up	20.00 to 30.00	82.50	1-3/4	1-3/8	2.5	J1-15
1938 SPORTWIN	42870001 and up	25.00 to 35.00	82.50	1-3/4	1-3/8	3.0	J1-15
1939 SPORTWIN	43030001 and up	30.00 to 40.00	82.50	1-3/4	1-3/8	3.3	J8
1940 SPORTWIN	43530001 and up	40.00 to 50.00	82.50	1-3/4	1-3/8	3.5	H10
1941 SPORTWIN	436800001 and up	42.50 to 55.00	89.50	1-3/4	1-3/8	3.3	H10
FISHERMAN							
1934 FISHERMAN	40160001 and up	\$15.00 to \$30.00	\$ 94.50	2	1-5/8	4	M6
1935 FISHERMAN	40930001 and up	20.00 to 40.00	95.00	2	1-5/8	4	M6
1936 FISHERMAN	41480001 and up	25.00 to 45.00	110.00	2	1-5/8	4.4	M6
1937 FISHERMAN	42270001 and up	30.00 to 50.00	115.00	2	1-5/8	4.4	M6
1938 FISHERMAN	42670001 and up	35.00 to 55.00	115.00	2	1-5/8	4.7	M6
1939 FISHERMAN	43090001 and up	40.00 to 60.00	115.00	2	1-5/8	5.4	M6
ZEPHYR							
1940 ZEPHYR	435900001 to 435905299	\$60.00 to \$75.00	\$127.50	1-1/2	1-3/8	5.4	J10 Com.
1941 ZEPHYR	435905000 and up	65.00 to 80.00	127.50	1-1/2	1-3/8	5.4	J10 Com.
WEEDLESS FISHERMAN							
1935 WEEDLESS FISHERMAN	40920001 and up	\$25.00 to \$35.00	\$105.00	2	1-5/8	4	M6
1936 WEEDLESS FISHERMAN	41520001 and up	30.00 to 40.00	120.00	2	1-5/8	4.4	M6
1938 WEEDLESS FISHERMAN	42690001 and up	35.00 to 45.00	135.00	2	1-5/8	4.7	M6
1939 WEEDLESS FISHERMAN	43120001 to 431202000	45.00 to 55.00	135.00	2	1-5/8	5.4	M6
1940 WEEDLESS FISHERMAN	431202001 and up	55.00 to 65.00	135.00	2	1-5/8	5.4	M6
LIGHTWIN							
1931 LIGHTWIN	4020001 and up	\$ 7.50 to \$12.50	\$ 99.75	2	1-5/8	4	M6
1932 LIGHTWIN	4070001 and up	12.50 to 20.00	97.75	2	1-5/8	4	M6
1933 LIGHTWIN	4420001 and up	15.00 to 22.50	99.75	2	1-5/8	5.1	M6
1934 LIGHTWIN	40200001 and up	17.50 to 30.00	110.00	2	1-5/8	5.1	M6
1935 LIGHTWIN	40970001 and up	35.00 to 50.00	115.00	2	1-5/8	4.6	M6
1936 LIGHTWIN	415300001 and up	37.50 to 52.50	115.00	2	1-5/8	4.7	M6
1937 LIGHTWIN	422100001 and up	40.00 to 55.00	125.00	2	1-5/8	4.7	M6
1938 LIGHTWIN	428900001 and up	45.00 to 60.00	125.00	2	1-5/8	4.7	M6
STURDITWIN							
1932 STURDITWIN	4200001 and up	\$15.00 to \$25.00	\$128.50	2-1/4	1-7/8	8	M6
1933 STURDITWIN	4200001 and up	15.00 to 25.00	115.00	2-1/4	1-7/8	5.8	M6



YEAR & MODEL	MOTOR SERIAL NUMBER	SUGGESTED TRADE-IN VALUE	ORIGINAL LIST PRICE	BORE	STROKE	H. P.	SPARK PLUG
LIGHTTWIN IMPERIAL							
1934	LIGHTTWIN IMPERIAL	40300001 and up	\$25.00 to \$30.00	\$140.00	2	1-5/8	5.5 AC-G5
1935	LIGHTTWIN IMPERIAL	41020001 and up	30.00 to 40.00	145.00	2	1-5/8	5 AC-G5
1936	LIGHTTWIN IMPERIAL	41650001 and up	40.00 to 50.00	145.00	2	1-5/8	5 AC-G5
FLEETWIN							
1932	FLEETWIN	4180001 and up	\$20.00 to \$30.00	\$157.50	2-1/4	1-7/8	11 M6
1933	FLEETWIN	4500001 and up	25.00 to 35.00	149.50	2-1/4	1-7/8	8.5 M6
1934	FLEETWIN	40340001 and up	30.00 to 45.00	149.50	2-1/4	1-7/8	8.5 M6
LIGHTFOUR							
1934	LIGHTFOUR IMPERIAL	40420001 and up	\$35.00 to \$50.00	\$170.00	1-3/4	1-35/64	9.2 M5
1935	LIGHTFOUR IMPERIAL	41110001 and up	45.00 to 65.00	167.50	1-3/4	1-35/64	9.2 M5
1936	LIGHTFOUR IMPERIAL	41780001 and up	55.00 to 70.00	167.50	1-3/4	1-35/64	9.2 M5
1937	LIGHTFOUR	42310001 and up	55.00 to 80.00	175.00	1-3/4	1-35/64	9.2 M5
1938	LIGHTFOUR	42710001 and up	60.00 to 80.00	177.50	1-3/4	1-35/64	9.2 M5
1939	LIGHTFOUR	43150001 to 431503000	65.00 to 85.00	177.50	1-3/4	1-35/64	9.7 M5
1940	LIGHTFOUR	431503001 and up	70.00 to 90.00	177.50	1-3/4	1-35/64	9.7 M5
1941	LIGHTFOUR	431503001 and up	80.00 to 105.00	185.00	1-3/4	1-35/64	9.7 M5
SPORTFOUR							
1931	SPORTFOUR	9020001 and up	\$25.00 to \$35.00	\$275.00	2	2	18 M5
1932	SPORTFOUR	9120001 and up	30.00 to 40.00	220.00	2	2	18 M5
1933	SPORTFOUR	9200001 and up	40.00 to 50.00	215.00	2	2	16.2 M5
1934	SPORTFOUR	90000001 and up	45.00 to 60.00	225.00	2	2	16.2 M5
1935	SPORTFOUR	90080001 and up	55.00 to 70.00	235.00	2	2	16.2 M5
1936	SPORTFOUR	90150001 and up	65.00 to 75.00	235.00	2	2	16.2 M5
1937	SPORTFOUR	90220001 and up	70.00 to 80.00	245.00	2	2	16.2 M5
1938	SPORTFOUR	90260001 and up	75.00 to 85.00	245.00	2	2	16.2 M5
1939	SPORTFOUR	90310001 and up	80.00 to 90.00	245.00	2	2	16.2 M5
1940	SPORTFOUR	903500001 and up	90.00 to 110.00	245.00	2	2	17.4 M5
1941	SPORTFOUR	903500001 and up	95.00 to 115.00	255.00	2	2	17.4 M5
22 H.P. SPEEDITWIN (3 Port)							
1930	SPEEDITWIN	1560001 and up	\$25.00 to \$35.00	\$250.00	2-3/4	2-1/2	22 7
1930	SPEEDITWIN ELECTRIC	1670001 and up	45.00 to 55.00	315.00	2-3/4	2-1/2	22 7
1931	SPEEDITWIN	1560001 and up	30.00 to 40.00	220.00	2-3/4	2-1/2	22 7
1931	SPEEDITWIN ELECTRIC	1670001 and up	50.00 to 60.00	265.00	2-3/4	2-1/2	22 7
SPEEDITWIN (Rotary Valve)							
1931	SPEEDITWIN	6010001 and up	\$30.00 to \$40.00	\$250.00	2-3/4	2-1/2	25 M5
1932	SPEEDITWIN	6180001 and up	35.00 to 45.00	235.00	2-3/4	2-1/2	25 M5
1933	SPEEDITWIN	6340001 and up	40.00 to 70.00	230.00	2-3/4	2-1/2	21.1 M5
1933	SPEEDITWIN	1560001 and up	35.00 to 45.00	175.00	2-3/4	2-1/2	18.9 7
1934	SPEEDITWIN	60000001 and up	55.00 to 75.00	245.00	2-3/4	2-1/2	21.1 M5
1935	SPEEDITWIN	60110001 and up	60.00 to 85.00	245.00	2-3/4	2-1/2	21.1 M5
1939	SPEEDITWIN	60390001 to 603900900	75.00 to 95.00	270.00	2-3/4	2-1/2	22.5 M5
1940	SPEEDITWIN	603900901 and up	90.00 to 115.00	270.00	2-3/4	2-1/2	22.5 M5
1941	SPEEDITWIN	603900901 and up	100.00 to 120.00	280.00	2-3/4	2-1/2	22.5 M5
SPEEDIFOUR AND SPEEDIQUAD							
1931	SPEEDIFOUR	7040001 and up	\$35.00 to \$50.00	\$325.00	2-1/2	2-1/2	35 M5
1932	SPEEDIFOUR	7150001 and up	40.00 to 60.00	310.00	2-1/2	2-1/2	36 M5
1933	SPEEDIFOUR	7280001 and up	55.00 to 65.00	295.00	2-1/2	2-1/2	31.2 M5
1934	SPEEDIQUAD	70000001 and up	65.00 to 75.00	325.00	2-1/2	2-1/2	31.2 M5
1935	SPEEDIQUAD	70080001 and up	75.00 to 90.00	325.00	2-1/2	2-1/2	31.2 M5
1936	SPEEDIQUAD	70150001 and up	85.00 to 100.00	325.00	2-1/2	2-1/2	31.2 M5
1937	SPEEDIFOUR	70220001 and up	90.00 to 115.00	335.00	2-1/2	2-1/2	33.4 M5
1938	SPEEDIFOUR	70260001 and up	100.00 to 125.00	335.00	2-1/2	2-1/2	33.4 M5
1939	SPEEDIFOUR	70310001 to 703100500	110.00 to 135.00	335.00	2-1/2	2-1/2	33.4 M5
1940	SPEEDIFOUR	703100501 and up	125.00 to 150.00	335.00	2-1/2	2-1/2	33.4 M5
1941	SPEEDIFOUR	703100501 and up	145.00 to 175.00	347.50	2-1/2	2-1/2	33.4 M5
BIG FOUR							
1931	BIG FOUR	8020001 and up	\$20.00 to \$40.00	\$375.00	2-3/4	2-3/4	40 M5
1932	BIG FOUR	8140001 and up	25.00 to 45.00	375.00	2-3/4	2-3/4	40 M5

On motors equipped with Electric Starter add \$12.50 to allowance listed.  
 On motors equipped with Simplex Starter add \$5.00 to allowance listed.

NOTE: Prices are for motors in fair condition -- deductions should be made for repairs or reconditioning.

SUGGESTED ELTO TRADE-IN ALLOWANCE SCHEDULE FOR 1942

YEAR & MODEL	MOTOR SERIAL NUMBER	SUGGESTED TRADE-IN VALUE	ORIGINAL LIST PRICE	BORE	STROKE	H. P.	SPARK PLUG
SERVICE TWIN (Battery Ignition)							
1921	SERVICE TWIN	1000 to 1920	\$ 5.00 to \$10.00	\$135.00	2-1/4	2	Champ. 7
1922	SERVICE TWIN	1921 to A6519	5.00 to 10.00	135.00	2-1/4	2	3 7
1923	SERVICE TWIN	A6520 to C12000	5.00 to 10.00	145.00	2-1/4	2	3 7
1924	SERVICE TWIN	C12001 to C20000	5.00 to 10.00	145.00	2-1/4	2	3 7
1925	SERVICE TWIN	C20001 to G30000	5.00 to 10.00	145.00	2-1/4	2	3 7
1926	SERVICE TWIN	G30001 to G44900	5.00 to 10.00	145.00	2-1/2	2	4 7
1927	SERVICE TWIN	J45000 to J54800	5.00 to 12.50	145.00	2-1/2	2	4 7
1928	SERVICE TWIN	J54800 to J56859	7.50 to 17.50	145.00	2-1/2	2	4 7
1931	SERVICE TWIN	3580001 and up	10.00 to 20.00	145.00	2-1/2	2	4 7
SERVICE SPEEDSTER (Battery Ignition)							
1928	SERVICE SPEEDSTER	60000 to 69999	\$15.00 to \$20.00	\$165.00	2-1/2	2	7 7
1929	SERVICE SPEEDSTER	80000 to 89999	15.00 to 20.00	165.00	2-1/2	2	7 7
1930	SERVICE SPEEDSTER	3000001 and up	20.00 to 30.00	165.00	2-1/2	2	7 M6
1930	HI-SPEED SPEEDSTER	3020001 and up	20.00 to 30.00	185.00	2-1/2	2	11 M6
1931	SERVICE SPEEDSTER	3480001 and up	20.00 to 30.00	165.00	2-1/2	2	8 7



YEAR & MODEL	MOTOR SERIAL NUMBER	SUGGESTED TRADE-IN VALUE	ORIGINAL LIST PRICE	BORE	STROKE	H. P.	SPARK PLUG
LIGHTWEIGHT (Battery Ignition)							
1929	LIGHTWEIGHT	90000 to 99999	\$10.00 to \$15.00	\$150.00	2	1-5/8	3 AC-G8
1930	LIGHTWEIGHT	3090001 and up	10.00 to 15.00	150.00	2	1-5/8	3-1/2 AC-G8
1931	SPECIAL LIGHTWEIGHT	3600001 and up	12.50 to 17.50	87.50	2	1-5/8	3-1/2 AC-G8
1931	LIGHTWEIGHT	4010001 and up	7.50 to 12.50	99.75	2	1-5/8	4 M6
1932	LIGHTWEIGHT	4110001 and up	10.00 to 15.00	97.75	2	1-5/8	4 M6
1933	LIGHTWEIGHT	4440001 and up	15.00 to 20.00	99.75	2	1-5/8	5.1 M6
CUB (Magneto)							
1939	CUB	426400001 to 426403850	\$10.00 to \$15.00	\$ 29.50	1-1/8	1	.5 J4
1940	CUB	426403851 and up	12.50 to 20.00	26.50	1-1/8	1	.5 H10
1941	CUB	426403851 and up	14.50 to 20.00	26.50	1-1/8	1	.5 H10
PAL (Magneto)							
1937	PAL	420300001 and up	\$ 5.00 to \$10.00	\$ 37.50	1-3/8	1-3/8	.9 J8
1938	PAL	425300001 and up	7.50 to 15.00	37.50	1-3/8	1-3/8	1.1 J8
1939	PAL	426600001 to 426607000	12.50 to 20.00	37.50	1-3/8	1-3/8	1.1 H10
1940	PAL	426607001 and up	18.00 to 25.00	37.50	1-3/8	1-3/8	1.1 H10
1941	PAL	426607001 and up	20.00 to 27.50	37.50	1-3/8	1-3/8	1.1 H10
ACE (Magneto)							
1936	ACE	414500001 to 414503000	\$ 7.50 to \$10.00	\$ 45.00	1-3/4	1-35/64	1.4 C7
1937	ACE	414503001 and up	10.00 to 15.00	47.50	1-3/4	1-35/64	1.4 C7
1937	ACE	420500001 and up	10.00 to 15.00	47.50	1-3/4	1-35/64	1.4 C7
1938	ACE	425600001 and up	15.00 to 20.00	47.50	1-3/4	1-35/64	1.8 C7
1939	ACE	430100001 and up	20.00 to 25.00	47.50	1-3/4	1-35/64	1.8 C7
1939	ACE	432900001 and up	20.00 to 25.00	47.50	1-3/4	1-35/64	1.8 C7
1940	ACE	435100001 and up	22.50 to 27.50	47.50	1-3/4	1-35/64	1.8 C7
1941	ACE	435100001 and up	25.00 to 30.00	47.50	1-3/4	1-35/64	1.8 C7
SUPER SINGLE (Battery - Ignition)							
1933	SUPER SINGLE	4360001 and up	\$ 7.50 to \$15.00	\$ 69.75	2	1-5/8	2.2 M6
1934	SUPER SINGLE	40080001 and up	10.00 to 20.00	79.50	2	1-5/8	2.2 M6
1934	SUPER SINGLE	40100001 and up	12.50 to 22.50	79.50	2	1-5/8	2.2 M6
HANDITWIN (Magneto)							
1936	HANDITWIN	415800001 to 415802500	\$15.00 to \$20.00	\$ 65.00	1-3/4	1-3/8	2.5 C7
1937	HANDITWIN	415802501 and up	17.50 to 25.00	67.50	1-3/4	1-3/8	2.5 C7
1937	HANDITWIN	421200001 and up	17.50 to 25.00	67.50	1-3/4	1-3/8	2.5 C7
1938	HANDITWIN	426100001 and up	22.50 to 30.00	67.50	1-3/4	1-3/8	2.8 C7
1939	HANDITWIN	430700001 and up	27.50 to 35.00	67.50	1-3/4	1-3/8	3.0 C7
1939	HANDITWIN	435200001 and up	27.50 to 35.00	67.50	1-3/4	1-3/8	3.0 C7
1940	HANDITWIN	435700001 and up	32.50 to 40.00	67.50	1-3/4	1-3/8	3.0 C7
1941	HANDITWIN	435700001 and up	35.00 to 42.50	68.50	1-3/4	1-3/8	3.0 C7
FOLDLIGHT							
1930	FOLDLIGHT MAGNETO	1620001 and up	\$ 7.50 to \$15.00	\$145.00	1-3/4	1-5/8	2-3/4 M6
1931	FOLDLIGHT BATTERY	4040001 and up	7.50 to 12.50	125.00	1-3/4	1-5/8	2-3/4 M6
FISHERMAN (Battery Ignition)							
1932	FISHERMAN	4130001 to 4133499	\$ 7.50 to \$12.50	\$ 87.75	2	1-5/8	4 M6
1933	FISHERMAN	4133500 and up	10.00 to 15.00	82.75	2	1-5/8	4 M6
1934	FISHERMAN	40180001 and up	12.50 to 20.00	94.50	2	1-5/8	4 M6
1935	FISHERMAN	40950001 and up	17.50 to 25.00	95.00	2	1-5/8	4 M6
SERVICE TWIN (Magneto)							
1936	SERVICE TWIN	41610001 and up	\$17.50 to \$25.00	\$ 95.00	2	1-5/8	4.3 M6
1936	SERVICE TWIN	41630001 and up	17.50 to 25.00	95.00	2	1-5/8	4.3 M6
1936	SERVICE TWIN Revers-	41510001 and up	17.50 to 25.00	100.00	2	1-5/8	4.3 M6
1937	SERVICE TWIN ing	42160001 and up	25.00 to 35.00	97.50	2	1-5/8	4.3 M6
1937	SERVICE TWIN	422900001 and up	25.00 to 35.00	112.50	2	1-5/8	4.3 M6
LIGHTWIN							
1934	LIGHTWIN BATTERY	40240001 and up	\$22.50 to \$32.50	\$110.00	2	1-5/8	5.1 M6
1935	LIGHTWIN BATTERY	40990001 and up	27.50 to 37.50	115.00	2	1-5/8	4.6 M6
1939	LIGHTWIN	431300001 to 431303000	32.50 to 42.50	97.50	2	1-5/8	5.0 M6
1940	LIGHTWIN	431303001 and up	55.00 to 70.00	97.50	2	1-5/8	5.0 M6
1941	LIGHTWIN	431303001 and up	60.00 to 75.00	99.50	2	1-5/8	5.0 M6
LIGHTWIN IMPERIAL (Battery Ignition)							
1934	LIGHTWIN IMPERIAL	403200001 and up	\$20.00 to \$30.00	\$140.00	2	1-5/8	5.5 AC-G5
1935	LIGHTWIN IMPERIAL	410600001 and up	27.50 to 37.50	145.00	2	1-5/8	5 AC-G5
SERVICE "A" (Battery Ignition)							
1932	SERVICE "A"	4240001 and up	\$10.00 to \$15.00	\$128.50	2-1/4	1-7/8	5.8 M6
1933	SERVICE "A"	4240001 and up	10.00 to 15.00	115.00	2-1/4	1-7/8	5.8 M6
SUPER "A" (Battery Ignition)							
1932	SUPER "A"	4220001 and up	\$15.00 to \$25.00	\$157.50	2-1/4	1-7/8	11 M6
1933	SUPER "A"	4560001 and up	20.00 to 30.00	149.50	2-1/4	1-7/8	8.5 M6
FLEETWIN							
1934	FLEETWIN BATTERY	40380001 and up	\$25.00 to \$35.00	\$149.50	2-1/4	1-7/8	8.5 M6
1939	FLEETWIN MAGNETO	433500001 to 433500600	55.00 to 70.00	145.00	2-1/4	1-7/8	8.5 M6
1940	FLEETWIN	433500601 and up	65.00 to 80.00	145.00	2-1/4	1-7/8	8.5 M6
1941	FLEETWIN	433500601 and up	70.00 to 85.00	150.00	2-1/4	1-7/8	8.5 M6
HANDIFOUR (Magneto)							
1937	HANDIFOUR	421900001 and up	\$40.00 to \$50.00	\$157.50	1-3/4	1-35/64	9.2 Champ. M5
SPECIAL SPEEDSTER (Battery Ignition)							
1931	SPECIAL SPEEDSTER	3400001 and up	\$20.00 to \$30.00	\$165.00	2-1/2	2	8 7
1931	SPECIAL SPEEDSTER	9050001 and up	12.50 to 20.00	170.00	2-3/4	2-3/32	9 7
1932	SPECIAL SPEEDSTER	9050001 and up	12.50 to 20.00	155.00	2-3/4	2-3/32	9 7
1933	SPECIAL SPEEDSTER	9050001 and up	12.50 to 20.00	125.00	2-3/4	2-3/32	9 7



YEAR & MODEL	MOTOR SERIAL NUMBER	SUGGESTED TRADE-IN VALUE	ORIGINAL LIST PRICE	BORE	STROKE	H. P.	SPARK PLUG	
SENIOR SPEEDSTER (Battery Ignition)								
1930	SENIOR SPEEDSTER	3100001 to 3100999	\$15.00 to \$20.00	\$215.00	2-1/2	2-1/2	14	M6
1931	SENIOR SPEEDSTER	3101000 to 3101499	15.00 to 25.00	185.00	2-1/2	2-1/2	14	M6
1932	SENIOR SPEEDSTER	3101500 and up	20.00 to 30.00	180.00	2-1/2	2-1/2	14	M6
1933	SENIOR SPEEDSTER	3610001 and up	20.00 to 35.00	145.00	2-1/2	2-1/2	13.7	M6
LIGHTFOUR IMPERIAL (Battery Ignition)								
1934	LIGHTFOUR IMPERIAL	40440001 and up	\$20.00 to \$35.00	\$170.00	1-3/4	1-35/64	9.2	M5
1935	LIGHTFOUR IMPERIAL	41150001 and up	30.00 to 40.00	167.50	1-3/4	1-35/64	9.2	M5
JUNIOR QUAD (Battery Ignition)								
1931	JUNIOR QUAD	9000001 and up	\$20.00 to \$35.00	\$275.00	2	2	18	M5
1932	JUNIOR QUAD	9140001 and up	30.00 to 45.00	220.00	2	2	18	M5
1933	JUNIOR QUAD	9240001 and up	40.00 to 55.00	215.00	2	2	16.2	M5
SPORTFOUR (Battery Ignition)								
1934	SPORTFOUR	90040001 and up	\$45.00 to \$60.00	\$225.00	2	2	16.2	M5
1935	SPORTFOUR	90130001 and up	50.00 to 65.00	235.00	2	2	16.2	M5
SUPER "C" (Battery Ignition)								
1931	SUPER "C"	6050001 and up	\$30.00 to \$45.00	\$250.00	2-3/4	2-1/2	25	M5
1932	SUPER "C"	6240001 and up	35.00 to 50.00	235.00	2-3/4	2-1/2	25	M5
1933	SUPER "C"	6380001 and up	40.00 to 55.00	230.00	2-3/4	2-1/2	21.1	M5
SPEEDITWIN								
1934	SPEEDITWIN BATTERY	60040001 and up	\$40.00 to \$50.00	\$245.00	2-3/4	2-1/2	21.1	M5
1935	SPEEDITWIN BATTERY	60150001 and up	50.00 to 60.00	245.00	2-3/4	2-1/2	21.1	M5
1936	SPEEDITWIN MAGNETO	601800001 and up	65.00 to 80.00	245.00	2-3/4	2-1/2	21.1	M5
1937	SPEEDITWIN MAGNETO	602600001 and up	70.00 to 90.00	250.00	2-3/4	2-1/2	22.5	M5
1938	SPEEDITWIN MAGNETO	603400001 and up	75.00 to 90.00	260.00	2-3/4	2-1/2	22.5	M5
SENIOR QUAD AND SPEEDIQUAD (Battery Ignition)								
1928	QUAD	70000 to 74999	\$10.00 to \$20.00	\$275.00	2-1/2	2	18	7
1929	QUAD	75000 to 79999	5.00 to 12.50	275.00	2-3/4	2-3/32	25	AC-GB
1930	SENIOR QUAD	3140001 and up	30.00 to 40.00	325.00	2-1/2	2-1/2	30	M5
1931	SENIOR QUAD	7000001 and up	35.00 to 45.00	325.00	2-1/2	2-1/2	35	M5
1932	SENIOR QUAD	7210001 and up	40.00 to 55.00	310.00	2-1/2	2-1/2	36	M5
1933	SENIOR QUAD	7320001 and up	45.00 to 60.00	295.00	2-1/2	2-1/2	31.2	M5
1934	SPEEDIQUAD	70040001 and up	60.00 to 70.00	325.00	2-1/2	2-1/2	31.2	M5
1935	SPEEDIQUAD	70130001 and up	70.00 to 85.00	325.00	2-1/2	2-1/2	31.2	M5
BIG QUAD (Battery Ignition)								
1931	BIG QUAD	8000001 and up	\$20.00 to \$40.00	\$375.00	2-3/4	2-1/2	40	M5
1932	BIG QUAD	8200001 and up	25.00 to 45.00	375.00	2-3/4	2-1/2	40	M5

NOTE: Prices are for motors in fair condition -- deduction should be made for repairs or reconditioning.



## Evinrude-Elto Distributors and Dealers

There are over 2,500 Evinrude-Elto distributors and dealers in the United States and Canada. Those listed below have been selected so as to give owners in various states fairly close contact with parts and service facilities, thereby saving time and expense. If you desire the name and address of the nearest service dealer, consult the local telephone directory. If no Elto or Evinrude dealer is listed, wire or write to the factory or the nearest distributor. \*Denotes Distributor. \*\*Denotes Parts Distributor only.

### ALABAMA

Alex D. Chambless,  
214 Moulton St.,  
Montgomery

### ALASKA

Alaska Transfer Company,  
Cordova

### ARIZONA

O. B. Marston Supply Co.,  
324-326 Central Ave. North,  
Phoenix

### ARKANSAS

Tedford's,  
700 Broadway,  
Little Rock

### CALIFORNIA

Marine Equipment Co.,  
5046 W. Pico Blvd.,  
Los Angeles  
\*John G. Rapp Co.,  
123 Second St.,  
San Francisco

### CANADA

\*The Alberta Motor Co., Ltd.,  
Low Level Bridge,  
Edmonton, Alta.  
\*H. E. Hebert,  
663 St. James St.,  
Montreal, Que.  
Evinrude Motors (Factory),  
Peterboro, Ont.  
\*A. A. Murphy & Sons, Ltd.,  
216 First Ave., North,  
Saskatoon, Sask.  
\*Maritime Oil & Supply Co.,  
Ltd.,  
81 Prince William St.,  
St. John, N. B.  
\*Watercraft Equipment Co.,  
146 King St., West,  
Toronto, Ont.  
\*R. Cliff Sangster,  
1925 Georgia St. W.,  
Vancouver, B. C.  
Breen Motor Co., Ltd.,  
247 Main St.,  
Winnipeg, Man.  
\*Canadian Automotive  
Equipment, Ltd.,  
175 Notre Dame East,  
Winnipeg, Man.

### CONNECTICUT

Harry H. Johnson,  
Boston Post Road,  
Branford  
\*C. E. French,  
56 Bridgeport Ave.,  
Devon  
A. T. Howe,  
441 S. Main St.,  
East Hartford  
Court Colver,  
Longhill Road,  
Groton

### DISTRICT OF COLUMBIA

\*\*S. King Fulton, Inc.,  
805 Main Ave., S. W.,  
Washington

### FLORIDA

\*Consolidated Automotive Co.,  
1167 W. Forsyth St.,  
Jacksonville  
Seminole Docks,  
2760 South Bayshore Drive,  
Miami  
D. M. Witherill,  
713 So. Palafox,  
Pensacola  
Edwards Motor Company,  
622 Zack St.,  
Tampa

### GEORGIA

P & G Service,  
142 Marietta St., Rear  
Atlanta  
F. Barney Smith,  
Augusta  
Motor Supply Co.,  
28 Abercorn St.,  
Savannah

### HAWAIIAN ISLANDS

Hawaiian Marine Sales,  
52 S. Queen St.,  
Honolulu

### IDAHO

Lud A. Drexler,  
Twin Falls

### ILLINOIS

Cramer's Outboard Motors  
1500 N. Wells St.,  
Chicago  
F. E. Ludolph,  
2257 Silverton Way,  
Chicago  
Maypole Boat & Motors,  
5901 W. Madison St.,  
Chicago  
Ted Kannig,  
Fox Lake, Ill.

### INDIANA

W. E. Nelson,  
127 E. Jefferson,  
South Bend

### IOWA

Waterloo Outboards,  
2153 E. Fourth St.,  
Waterloo

### LOUISIANA

\*Higgins Industries, Inc.,  
1755 St. Charles Ave.,  
New Orleans  
Holmes A. Thurmond,  
Box 233,  
Shreveport

### MAINE

Peters Outboard Service,  
633 Water St.,  
Randolph

### MARYLAND

Jenkins Marine Motor Sales  
329 N. Calvert,  
Baltimore

### MASSACHUSETTS

\*Thos. T. Parker, Inc.  
1022 Commonwealth Ave.,  
Boston  
Leo De Montigny,  
832 State St.,  
Springfield

### MICHIGAN

Mich. Outboard Motor Co.,  
6330 E. Jefferson Ave.,  
Detroit  
Evinrude Elto Flint Sales,  
2125 S. Saginaw St., Flint

### MINNESOTA

\*Reinhard Bros. Co., Inc.  
11-18 S. Ninth St.,  
Minneapolis  
R. L. Parks,  
Nisswa

### MISSOURI

\*\*Covert Boat & Engine Co.,  
1424 McGee St.,  
Kansas City  
\*\*Schneider Sales & Service,  
Neosho at So. Kingshighway,  
St. Louis

### MONTANA

Don Robertson,  
350 Dakota Ave.,  
Whitefish

### NEBRASKA

Van Avery Sptg. Goods Co.,  
1512 Harney St.,  
Omaha  
Mills Cycle Shop,  
117 West 5th St.,  
North Platte

### NEVADA

L. Lund,  
226 Chestnut St., Reno

### NEW HAMPSHIRE

McDuff Machine Co., Inc.  
Glendale and Lakeport

### NEW JERSEY

Edward L. McCarthy,  
616 Bayview Ave.,  
Absecon

### NEW YORK

\*Oluf Mikkelsen,  
393 Fourth Ave.,  
New York City  
\*Howard H. Vrooman,  
253 State St.,  
Watertown

### OHIO

\*Cleveland Yacht & Sup. Co.,  
3027 Detroit Ave.,  
Cleveland  
\*Schuler Marine Sales,  
Russells Point

### OKLAHOMA

\*Everett Motor Co.,  
420 E. Second St.,  
Tulsa

### OREGON

J. L. McCuddy,  
E. End Morrison St. Bridge,  
Portland

### PENNSYLVANIA

Outboard Boat & Motor Sales,  
Delaware River at Tacony-  
Palmyra Bridge,  
Philadelphia

\*\*Marine Equipment Co.,  
107 Federal St.,  
N. S. Pittsburgh

### RHODE ISLAND

H. L. Wood Co.,  
123 Dorrance St.,  
Providence

### SOUTH CAROLINA

J. J. W. Luden & Co.,  
Charleston

### TENNESSEE

R. Nowlin Boat & Cycle Co.,  
900 Church St.,  
Nashville

### TEXAS

Colonial Motor Co.,  
3219 Holmes St.,  
Dallas  
\*C. B. Delhomme,  
2101 Leeland Ave.,  
Houston

### UTAH

House of Hopper,  
140 E. Broadway,  
Salt Lake City

### VERMONT

Edgar Chiott & Son,  
Foot of King St.,  
Burlington

### VIRGINIA

Carwich Hardware,  
1711 East Main St.,  
Richmond

### WASHINGTON

\*S. V. B. Miller,  
79 Columbia St.,  
Seattle  
Ware, Cochrane & Coultas,  
422 Sprague Ave.,  
Spokane

### WISCONSIN

\*Morley-Murphy Co.,  
Green Bay  
Bergs, Inc.,  
2123 Atwood,  
Madison  
Evinrude Motors (Factory),  
4143 N. 27th St.,  
Milwaukee  
Thompson Boat Mart,  
Minocqua, Wis.  
Lem Willemsen,  
Phillips  
Art Miller, Jr.,  
Stevens Point  
\*Distributor.  
\*\*Parts Distributor.



MEMORANDA



Section XXV

INDEX

SUBJECT	PAGE No.	SUBJECT	PAGE No.
Advertising .....	7-8	Fuel System .....	33
Air Locks .....	33	Fuel Tanks—cleaning, dented .....	33
Aluminum Paint Formula .....	16	Fuel Tank, draining .....	13
Angle Adjustment .....	12	Fuel Tank, welding .....	34
Armature-Plate Installation, Straightening .....	30	Gaskets—cylinder, self-forming .....	35
Armature, Testing .....	25	Gasoline, regular, high test .....	15
Assembly, of motors shipped dismantled .....	13	Gear Housings .....	52-56
Bearings—bronze, fitting .....	42	Government requirements .....	59-60
Bearings—crankcase .....	44	Heavy Duty Reduction Gear .....	15-56
Boat Numbers .....	60	High Speed Boats .....	12
Breaker-arm—Assembly, Spring .....	25	Hoods, motor, removal .....	22
Carburetors, Check valve type .....	45	Horsepower, N.O.A. Certified .....	59
Cavitation .....	44	Identification .....	7-8
Center Bearing .....	44	Installation of motors on boats .....	12
Charts .....	5	Instructions, starting and operating .....	16-21
Chart, Magneto Check .....	32	Insurance, Outboard (N.O.A.) .....	59
Chromium plating cylinders .....	35	Keel, modification of .....	13
Cloverleaf Grinding Compound .....	45	Layout for Service Department .....	7
Coil—Tester .....	27-28	Lubrication Chart .....	83
Eiseman Tester .....	27	Lubrication, Heavy Duty Reduction Gear .....	15
Coil Testing .....	27-28	Lubrication Instructions .....	14
Cold weather precautions .....	58	Lubrication, lower units .....	15
Condenser—Tester, Testing .....	26-27	Lubrication, Magneto .....	24
Condenser, very weak .....	26	Lubrication, Racing Motors .....	14
Connecting Rods—bronze, clearances, roller bearing, straightening .....	38-39	Magnetos, types .....	24
Contact points, function of .....	25	Magneto, check chart .....	32
Contact points—adjusting, cleaning, installing .....	25-26	Magneto, testing .....	25
Co-Pilot .....	51	Magneto, testing equipment .....	32
Co-Pilot, adjustment .....	51	Magnets .....	24
Crankcase .....	40-42	Mixture Lever Friction .....	47
Crankshaft .....	40-42	Mufflers .....	45
Cylinders .....	35	Obstinate Trouble .....	57
Cylinder Gaskets .....	35	Operation, Principle of .....	11
Decalomania Transfers .....	35	Ordering, Instructions how to .....	10
Dents, in fuel tanks .....	33-34	Overhaul, Simple procedure .....	24
Dismantling motor .....	22	Permatex, gasket material .....	35
Dismantling "frozen" parts .....	22	Piston and Rings .....	36-37
Displacement Boats .....	12	Piston, burning .....	36
Eyelet Forming Tool .....	30	Piston, clearances .....	36
Federal Waters, requirements on .....	59	Piston Pin .....	38
Flooding .....	47	Piston Rings .....	36-37
Flywheels—installing, out of true .....	32	Piston Rings, lapping .....	37-38
Flywheels, removing .....	30-31	Pitch .....	43-44
Flywheel Tapers .....	32	Pivot Bearing Assembly .....	51
Forms .....	9	Planing Boats .....	12
Four-cycle Engine .....	11	Powerhead Assemblies .....	12
Frozen Parts .....	22	Propeller, bent .....	43
Fuel, confusion about .....	15	Propeller, cavitation .....	43
Fuel Line .....	33	Propeller, optional .....	43
Fuel Line Air Locks .....	33	Propeller, pitch and diameter .....	43
Fuel recommended .....	14-15	Propeller, slippage .....	43
		Propeller, standard .....	43



Section XXV

**INDEX— (Continued)**

SUBJECT	PAGE No.	SUBJECT	PAGE No.
Propeller, straightening .....	43	Spark Plug Chart .....	85
Publications; list of (Parts Book, Master, etc.) .....	9	Speed Control Lever Adjustment .....	30
Pump .....	52-56	Spray Elimination .....	13
Quick Tune-up .....	15-16	Spurious Parts .....	10
Racing, Service Motors .....	14	Steering Friction .....	51
Reduction Gear, Heavy Duty .....	15	Stern Brackets .....	51
Relief, Automatic Exhaust .....	45	Storage .....	8-58
Remagnetizing Magneto .....	24	Submerged Motor .....	57-58
Retainers .....	39	Tanks, fuel; see Fuel Tanks .....	33-34
Roller Bearing, Connecting Rod .....	39	Terminals, installing .....	30
Rooster Tails .....	13	Tilting friction .....	51
Rotary Valve .....	44	Timer Pin .....	25
Running in Motors .....	56	Transfer, decalcomania .....	35
Salt Water Precaution .....	58	Trouble Chart .....	89
Scoring, in cylinders .....	35	Tune-up .....	15-16
Scoring, Crankshaft .....	42	Two Cycle Engine .....	11
Selector, Boat and Motor .....	13	Warranty .....	9
Service Policy .....	9-10	Water, from muffler .....	45
Service School .....	57	Water, in cylinders .....	35
Shear Pin, Propeller .....	84	Water Jackets .....	35
Simplex Starter .....	22, 49, 50	Welding .....	34
Slippage, propeller .....	43	Wires, installing .....	30
Spark Plugs .....	25	Wires, old, worn .....	30
Spark Plug Adjustment .....	25	Wiring .....	30

**MEMORANDA**