

Johnson

Owners' Manual



Sea-Horse

"10"

MODELS
QD • QDL

INTRODUCTION

Welcome into the family of Johnson Sea-Horse owners — we are glad you chose a Johnson.

Your new Johnson Sea-Horse is designed and constructed to give you a maximum in service and performance for a motor of its size. You should study this instruction book in order to have a complete understanding of its operation and take full advantage of its many built-in features.

Your Johnson Sea-Horse is produced under the finest quality controlled production methods and built to give you many hours of dependable service. It has always been the belief of Johnson Motors that a sale does not complete the transaction between the manufacturer and the buyer. It establishes, rather, a new obligation — an obligation whereby Johnson Motors agrees to assist the buyer in obtaining utmost service from a Johnson Sea-Horse motor.

With this policy uppermost in our minds, it has been our endeavor to place a Johnson Service Station within easy reach of every Johnson Sea-Horse owner. Away from home, see the Dealer's Service Station list included with each motor.

Dependably yours,
JOHNSON MOTORS

INDEX

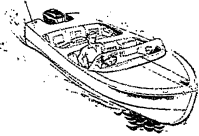
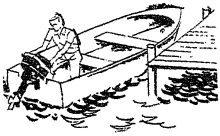

SPECIFICATIONS	Page
HERE'S HOW TO INSTALL YOUR MOTOR . . .	6
Proper Transom Height is Important . . .	6
Securing Motor to Boat . . .	6
Tilt Lock . . .	6
Angle Adjustment . . .	7
HOW TO GET STARTED . . .	8
Breaking In . . .	8
What Gasoline and Oil to Use . . .	8
Fuel Mixture . . .	8
Fuel Connection . . .	8
Starting . . .	9
Stopping . . .	9
EASY OPERATION—SIMPLE ADJUSTMENTS . . .	10
How to Shift and Control Speed . . .	10
Reverse Operation . . .	10
Proper Angle Adjustment . . .	10
Tilt Tension Adjustment . . .	10
Steering Tension Adjustment . . .	10
Idle Stop Adjustment . . .	11
Carburetor Adjustment . . .	11
Emergency Starting . . .	11
Removing Motor From Boat . . .	11
A MOTOR FOR EVERY PURPOSE . . .	12
TAKING CARE OF YOUR MOTOR . . .	14
Gear Lubrication . . .	14
Care of Motor When Operated in Salt Water . . .	14
Freezing Temperatures . . .	14
Drive Pin Replacement . . .	14
Lubrication Chart . . .	15
Removing Motor Shroud . . .	16
Spark Plug Recommendation and Replacement . . .	16
Cooling . . .	16
Adjusting Carburetor Levers . . .	17
Motors Dropped Overboard (Not Running) . . .	17

TAKING CARE OF YOUR MOTOR (Contd) Page	
Motors Dropped Overboard (Running) . . .	17
Motors Dropped Overboard (In Salt Water) . . .	17
Magneto Points Adjustment . . .	18
Cleaning Magneto Points . . .	18
Cleaning Fuel Filter . . .	18
Cleaning Carburetor Float Chamber . . .	19
Three Point Check List . . .	20
Before Storing Your Motor . . .	21
After Storing — Before Using . . .	21
EQUIPMENT FOR YOUR BOAT . . .	22
HOW TO GET PEAK PERFORMANCE . . .	23
Propeller . . .	23
Transom Height . . .	23
Angle Adjustment . . .	23
Carburetor Adjustment . . .	23
Gasoline . . .	23
Remote Controls . . .	23
JOHNSON ACCESSORIES INCREASE YOUR BOATING FUN . . .	24
Ship-Master Remote Control . . .	24
Single Fuel System . . .	24
Twin Fuel System . . .	24
Transom Plate . . .	24
Remote Control Adapter Kit . . .	24
Steering Handle . . .	25
Motor Stand . . .	25
Mile-Master Tank . . .	25
Generator Kit . . .	25
Chrome Pump Housing . . .	25
Choke and Start Plate — Twin . . .	25
Carrying Handle . . .	25
WHERE TO FIND MODEL AND SERIAL NUMBER . . .	26
REGISTRATION AND INSURANCE . . .	26
WARRANTY . . .	27

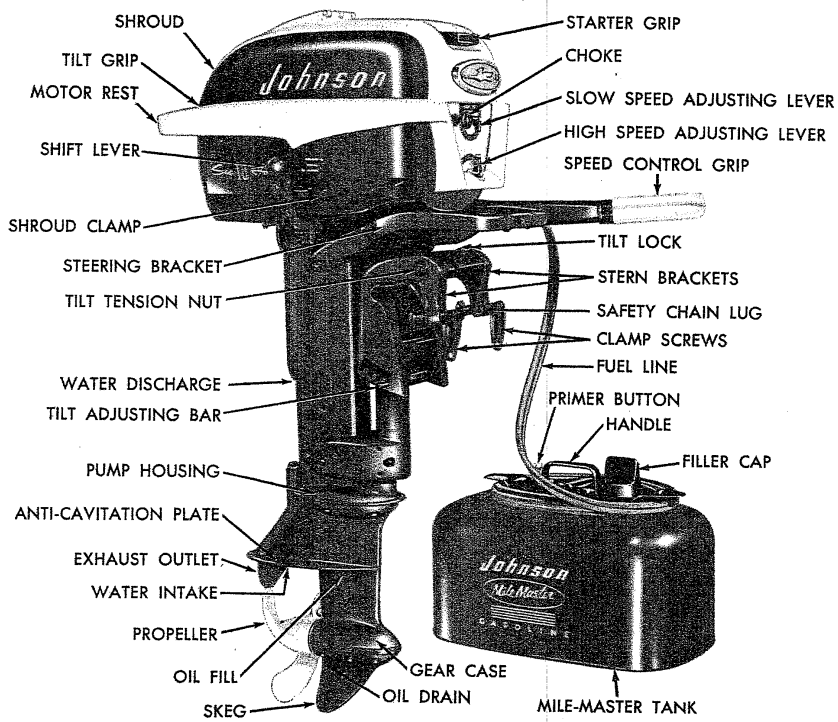

SPECIFICATIONS 10 H.P. (MODELS QD AND QDL)

POWER HEAD Two Cycle — Alternate Firing
 Two Port — Automatic Intake
 Bore and Stroke 2 $\frac{3}{8}$ x 1 $\frac{7}{8}$ "
 Number of Cylinders 2
 Piston Displacement 16.6 Cubic Inches
 OBC Brake H.P. at 4000 R.P.M. 10.0
 GEAR RATIO578
 IGNITION Magneto — Johnson
 MAGNETO BREAKER POINT GAP020
 SPARK PLUG GAP030

CARBURETOR Johnson
 GEAR SHIFT
 CONTROL Neutral, Forward, Reverse
 THROTTLE CONTROL Twist Grip Control —
 Ship-Master Remote Control
 PROPELLER 3 Blade 9" Dia. by 8 $\frac{1}{4}$ " Pitch
 FUEL TANK
 CAPACITY 6 Gals. Mile-Master Tank
 SPEED RANGE Slow Trolling to Over 20 MPH
 COOLING Vari-Volume Water Pump

	10 H. P. (Model QD)	10 H. P. (Model QDL)
Weight (Motor less Mile-Master Tank)	72 $\frac{1}{2}$ lbs.	74 lbs.
Weight of Mile-Master Fuel Tank (Empty)	13 lbs.	13 lbs.
Length	43"	48"
Width	11 $\frac{3}{4}$ "	11 $\frac{3}{4}$ "
Stern Height	15"	20"

JOHNSON MOTORS reserves the right to change weight, construction materials or specifications without notice and without obligation.

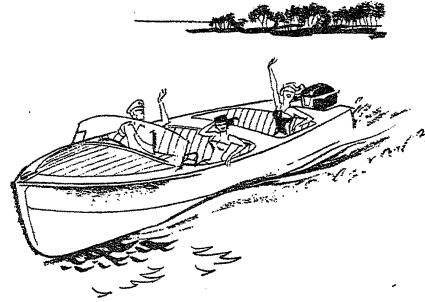

HERE'S HOW TO

PROPER TRANSOM HEIGHT IS IMPORTANT

Your Johnson motor is designed to fit transoms which conform with transom standards adopted by the boat building industry and the Outboard Boating Club of America. The proper transom (stern) vertical height for the 10 H.P. (Model QD) motor is 15 inches and, for the 10 H.P. (Model QDL) motor is 20 inches.

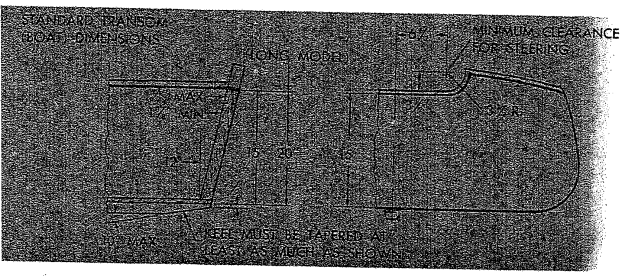

Proper transom height is essential to obtain maximum forward thrust from your motor.

If transom is too high propeller slippage (cavitation) may result, affecting general performance and proper cooling of the motor.

If transom is too low this will produce drag, resulting in some loss of speed and undesirable spray.

Interference from the keel is frequently the cause of propeller cavitation. By merely tapering the keel as illustrated, this can be eliminated.

SECURING MOTOR TO BOAT

Locate the center of transom by measuring and install motor, visually aligning power head with the located center. Immediately tighten clamp screws securely to avoid the possibility of loss overboard. Tighten clamp screws by hand only — do not use tools. Retighten clamp screws after approximately 30 minutes of operation. A lug is provided for attaching a safety chain or cable to the motor for anchoring to boat. NOTE — We recommend using a Johnson transom plate (available at Johnson dealers) to protect your boat and prevent loss of motor.

TILT LOCK

The tilt lock has two positions — “LOCK” and “RELEASE”. To tilt the motor move tilt lock to “RELEASE” position, grasp the tilt grip at rear of the shroud and pull motor toward you. With the tilt lock in “LOCK” position the motor is held in a vertical position for starting and operation. The motor will tilt only when it strikes an underwater object while traveling forward, but it will not tilt when operated in reverse. It is advisable to place tilt lock in released position when operating in shallow or obstructed waters.

INSTALL YOUR MOTOR

ANGLE ADJUSTMENT

The stern bracket has four notches for adjusting the motor to a vertical position to allow for transom angle. Adjust motor angle as follows:

1. Place tilt lock lever in "RELEASE" position and tilt motor away from transom.
2. Lift up on tilt adjusting bar and move bar in or out as necessary.
3. Move motor back against bar and place tilt lock in "LOCK" position so motor is perpendicular to water.

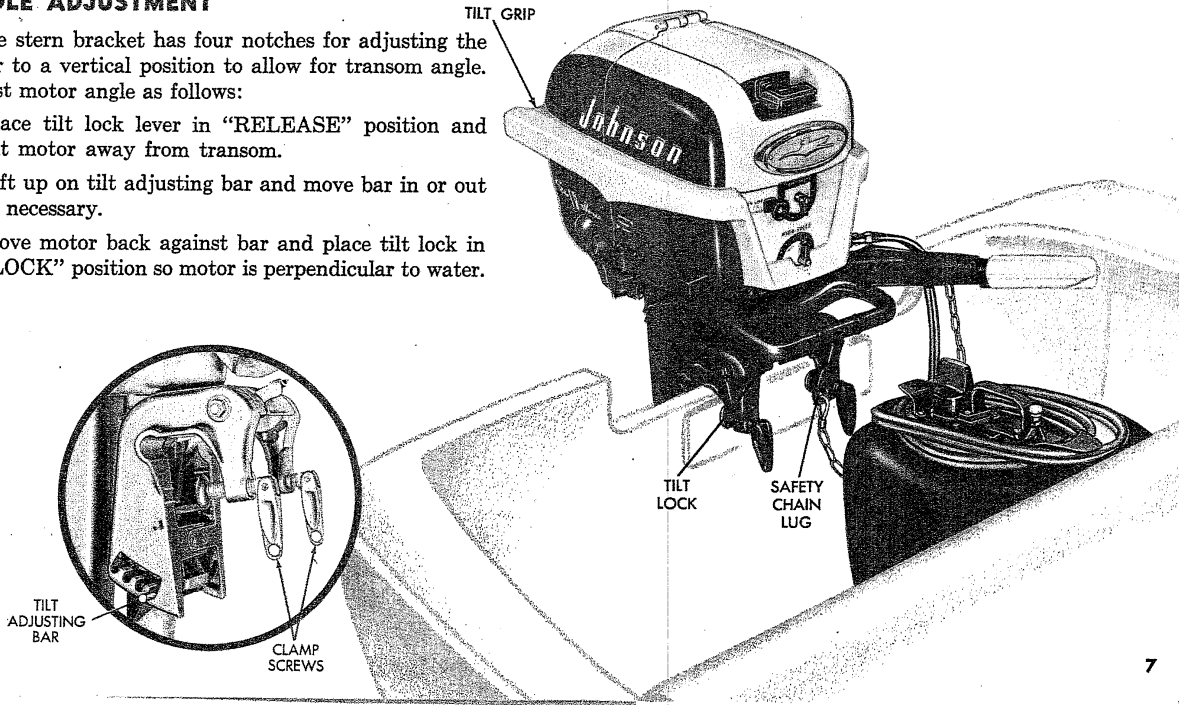

BREAKING IN

Do not operate motor at continuous full power for at least the first hour of operation. During break-in after the first 15 minutes, it is permissible to run full power at intervals, followed by part throttle operation. Frequently check operation of water pump (See Cooling).

CAUTION — Do not start or operate motor out of water as it will result in damage to water pump, overheating and too high r.p.m.

WHAT GASOLINE AND OIL TO USE

For best performance use regular gasoline. High octane premium gasoline may contain greater concentration of lead which may cause premature spark plug failure or fouling.

We recommend using a reputable outboard motor oil or a regular SAE 30 grade automotive engine oil (not heavy duty). Avoid use of low price, third grade (ML) oils.

The use of additive compounds such as "break-in" oils, "tune-up" compounds, "tonics", "friction reducing" compounds, etc. are entirely unnecessary and are not recommended for use in your motor.

FUEL MIXTURE

Pour one gallon of gasoline into Mile-Master tank (6 gallon capacity). Add one quart of oil and fill tank

HOW TO

with gasoline. FOR EASE OF MEASUREMENT when mixing smaller quantities of fuel, mix $\frac{1}{2}$ pint of oil per gallon of gasoline. **Be sure filler cap on tank is tight** to maintain constant pressure.

Use only the recommended oil to gasoline mixture ratio regardless of the claims made for some lubricants.

FUEL CONNECTION

Place Mile-Master Tank in boat so tank will not shift around. Be sure fuel line is not wedged under tank and allow fuel line slack to permit steering.

Slide fuel line connector onto motor coupling until locking lever snaps into position.

To disconnect fuel line depress locking lever on fuel line connector and pull off.

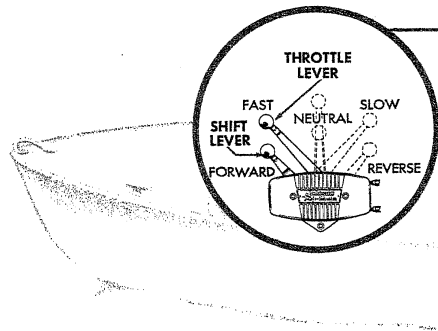

GET STARTED

STARTING (Nos. on illustration refer to steps below)

1. Turn speed control grip to position marked SHIFT on steering handle. If remote controls are used, move remote control throttle lever to SLOW position. NOTE — It is possible to shift only when the throttle lever is set at a safe speed for starting.
2. Do not start in gear. Move shift lever to NEUTRAL position.
3. Turn speed control grip to position marked START. If remote controls are used, move remote control throttle lever toward FAST until it stops.
4. Be sure tilt lock is in "LOCK" position.
5. Attach fuel line from Mile-Master tank to motor.
6. Depress, by hand, the primer button on Mile-Master tank several times until pressure is felt on button.
7. Set SLOW SPEED and HIGH SPEED levers between No. 3 and 4. In cold temperatures turn high

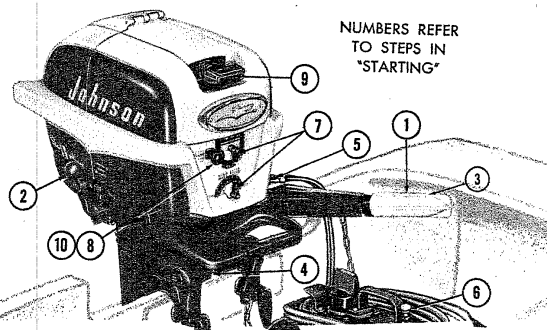

- speed lever to No. 5 or 6 for a richer mixture. Readjust between No. 3 and 4 after motor is started and warmed up.
8. Pull out choke.
 9. Slowly pull starter grip until starter engages, then pull rapidly. Allow starter cord to rewind before releasing starter grip to prevent damage to starter assembly.
 10. After starting motor, push choke in. Additional choking may be necessary to keep cold motor running. Reduce motor speed after starting.

STOPPING

Turn speed control grip to STOP position and pull choke. If remote controls are used, move remote control throttle lever back until it stops against SLOW position and pull out choke. If motor is tilted and is left in this position, disconnect the fuel supply line from motor.



TILT TENSION ADJUSTMENT

Tighten tilt tension nut only enough to maintain motor in any position of tilt.

REVERSE OPERATION

Motor will not tilt when operating in reverse. Avoid striking underwater obstructions to prevent damage to motor and boat.

PROPER ANGLE ADJUSTMENT

The vertical angle of the motor on the boat must be adjusted properly to obtain best performance from the motor and boat. The correct angle can only be determined by observing how the boat operates at full speed. (See "How To Get Peak Performance"). The angle adjustment should be made when trim and load distribution change.

HOW TO SHIFT AND CONTROL SPEED

Reduce motor speed before shifting and SNAP shift lever with QUICK ACTION to forward, neutral or reverse position as desired. PRECAUTION — To avoid damage to shifting mechanism, do not attempt shifting to forward or reverse when motor is not running.

To control motor speed, move throttle control toward FAST or SLOW position.

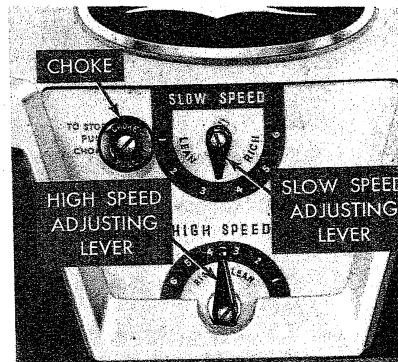

EASY OPERATION — SIMPLE

STEERING TENSION ADJUSTMENT

Adjust steering tension with motor mounted to boat by simply loosening or tightening screw in swivel bracket. Steering tension should be adjusted so you can feel a slight drag when turning. This will facilitate smooth steering.

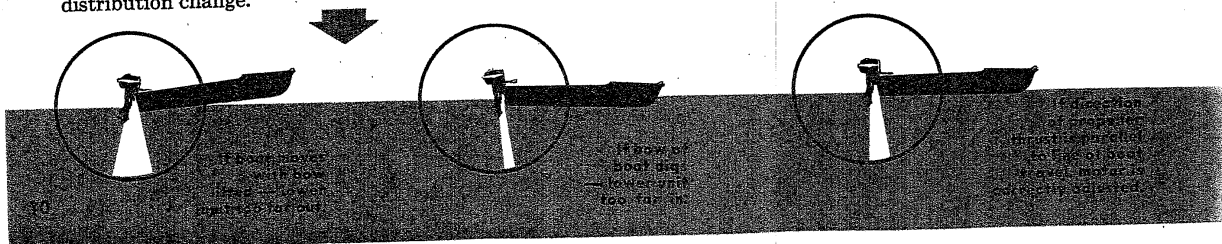

CARBURETOR ADJUSTMENT

Changes in fuel, altitude and climate may make it necessary to readjust the carburetor to obtain the best performance. Do it as follows when underway and motor is warm.

1. Move throttle control to FAST and adjust HIGH SPEED lever (turn left or right) until motor runs smoothly at highest speed.
2. Move throttle control to SLOW position. Then adjust SLOW SPEED lever (turn left or right) until motor idles smoothly.
3. Recheck HIGH SPEED lever adjustment.

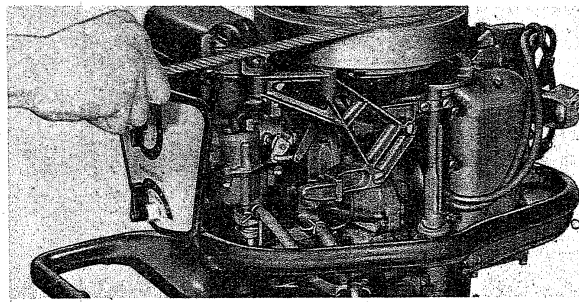

EMERGENCY STARTING

If Ready Pull starter fails, remove motor shroud (see page 16). Remove three screws attaching starter and lift it off. If the pull cord on the starter is broken it may be long enough to use as an emergency cord. If it is not long enough, use a $\frac{1}{4}$ inch cord with a knot tied in one end, place knot in pulley notch and wrap cord around clockwise. Start motor as described on page 9. CAUTION — Be sure shift lever is in neutral position when starting motor.

REMOVING MOTOR FROM BOAT

Loosen the clamp screws and lift motor vertically from boat. Hold motor in upright position to allow water to drain out. Do not place motor in a position where the lower unit will be higher than the power head — any water remaining in the exhaust tube may run into the cylinders and cause serious damage.

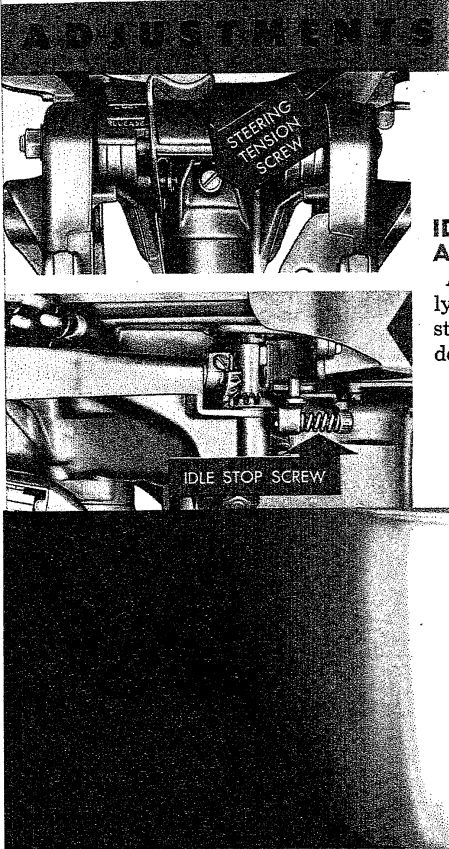

ADJUSTMENTS

IDLE STOP ADJUSTMENT

After motor is thoroughly warmed up, adjust idle stop screw in or out for desired idling speed.

A MOTOR FOR EVERY PURPOSE

12 VOLT STARTING (ELECTRIC MODELS)

QUICK DISCONNECT BATTERY LEADS

CHOKE STOPPING PROTECTS YOUR MOTOR

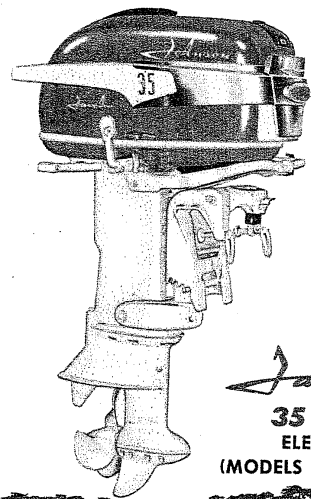

Javelin
35 H.P.
ELECTRIC
(MODELS RJE & RJEL)

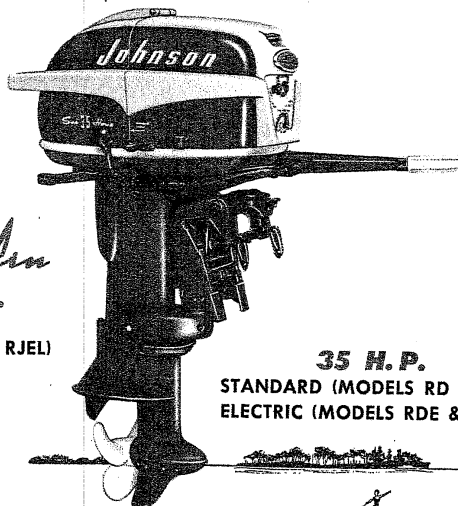
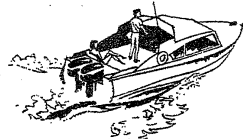

35 H.P.
STANDARD (MODELS RD & RDL)
ELECTRIC (MODELS RDE & RDEL)

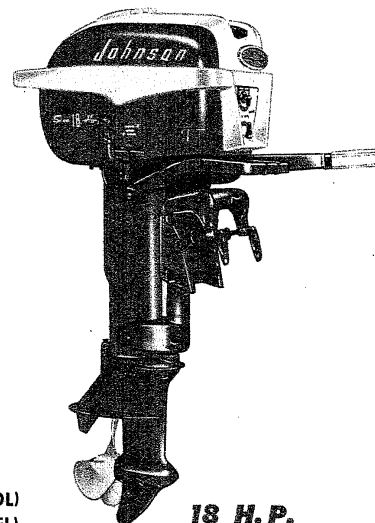

18 H.P.
STANDARD (MODELS FD & FDL)
ELECTRIC (MODELS FDE & FDEL)

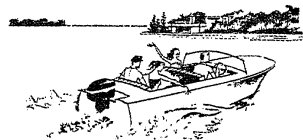

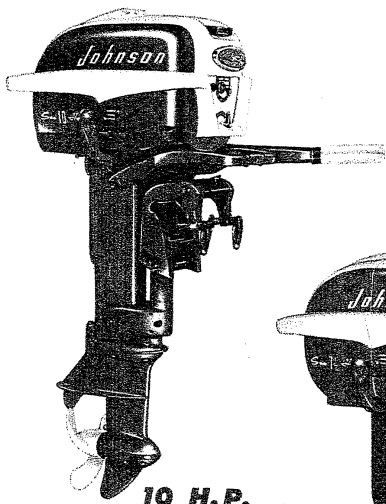

10 H.P.
(MODELS QD & QDL)



5 1/2 H.P.
(MODELS CD & CDL)

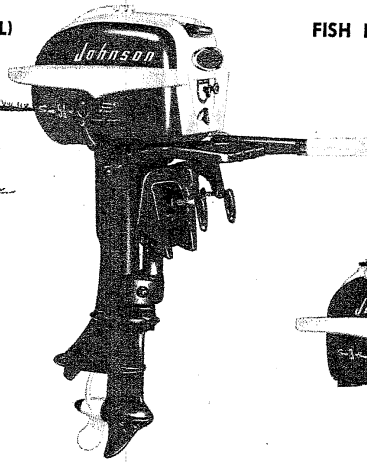

SLIP CLUTCH OR SHOCK-ABSORBER DRIVE

FISH LINE CUTTER

TWO-TONE FINISH

EASIER STARTING

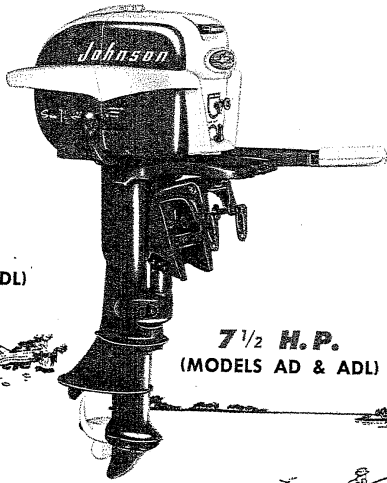

7 1/2 H.P.
(MODELS AD & ADL)

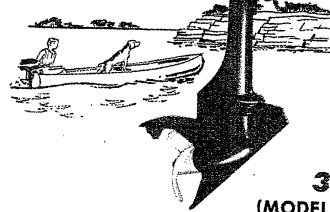

3 H.P.
(MODELS JW & JWL)

CARE OF MOTOR WHEN OPERATED IN SALT WATER

Never leave gear case in water when not in use for long periods of time. It is not necessary to flush cooling system after salt water operation. Rinse off exposed parts with fresh water and wipe with oily cloth. Move throttle to STOP position. Slowly pull manual starter grip several times to insure complete draining of the water pump.

CAUTION — Be extremely careful not to accidentally start the motor.

FREEZING TEMPERATURES

When operating in freezing temperatures, keep the lower unit submerged in the water at all times to avoid freezing and possible damage to the water pump. Be sure to completely drain water from cooling system when removing motor from boat (See — "Removing Motor From Boat" Page 11).

GEAR LUBRICATION

When a complete change of lubricant is required, place motor in vertical position and remove the lower plug and gasket, marked "OIL DRAIN" on side of gearcase. Then remove the upper plug and gasket, marked "FILL WITH HYPOID OIL". Permit oil to drain completely.

We recommend refilling gearcase as follows. Place a tube of hypoid oil as illustrated and fill gearcase through lower hole marked "OIL DRAIN" until lubricant appears at upper hole marked "FILL WITH HYPOID OIL". Replace upper plug and gasket securely before removing the tube from the lower hole. This will create an air lock and hold the oil in gearcase until lower plug and gasket can be secured.

If the recommended hypoid oil cannot be obtained in a tube, use a pressure oil can of the sealer type and follow same procedure as above.

In the event that the tube or pressure oil can (sealer type) are not available, proceed as follows. Drain gearcase and replace lower plug and gasket, marked "OIL DRAIN". Fill gearcase with available oil can through upper plug hole marked "FILL WITH HYPOID OIL". Air bubbles at fill hole may give impression that gearcase is full. Wait for a few minutes to permit air in gearcase to escape, then add more oil to fill. Replace fill plug and gasket securely.

TAKING CARE OF

DRIVE PIN REPLACEMENT

The propeller has a slip clutch to prevent shearing the drive pin if the propeller hits an obstruction. However, if the drive pin becomes worn or bent it can be easily replaced. **CAUTION** — To prevent accidental starting of the motor, do not rotate the propeller when the motor is in gear. **BE SURE SHIFT LEVER IS IN NEUTRAL POSITION.**

To replace drive pin, pull out cotter pin and remove propeller nut. The damaged drive pin can be driven out with a new pin when it is installed. When replacing propeller nut, tighten securely and align cotter pin holes. (If propeller nut is not drawn up tight enough, excessive drive pin wear will result). Install cotter pin (use new pin if necessary) bending ends over against nut. Use genuine Johnson drive pin for maximum protection.

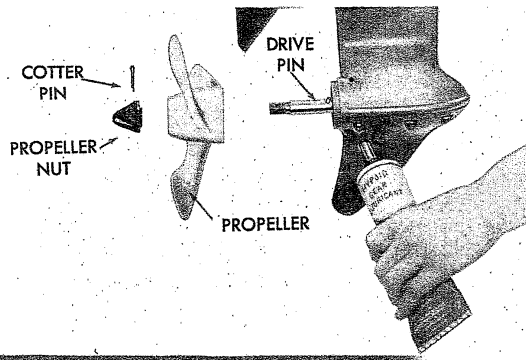

YOUR MOTOR

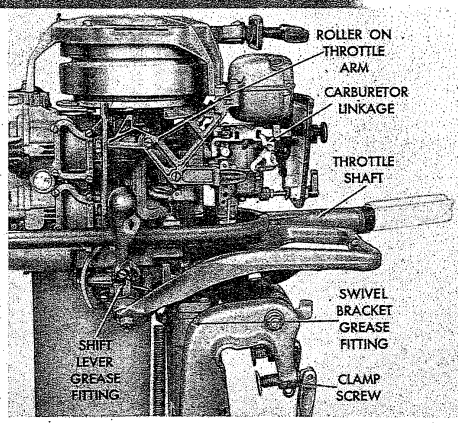

LUBRICATION CHART

LUBRICATION POINT	LUBRICANT	HOW OFTEN	
		FRESH WATER	SALT WATER
Gearcase	7.43 ounces — SAE Automotive hypoid gear lubricant. In <i>Emergency Only</i> use outboard motor oil or another SAE 30 engine oil, but replace with hypoid gear lubricant as soon as possible.	First 5 hrs. of operation. Check oil level and add if necessary. Check oil level at least every 50 hrs. of operation. Drain and fill gearcase once each season.	Same as "Fresh Water"
Swivel Bracket	Outboard waterproof gear grease. (Use pressure gun).	60 days	30 days
Shift Lever	Outboard waterproof gear grease. (Use pressure gun).	60 days	30 days
Throttle Shaft and Gear	SAE 30 Oil	60 days	30 days
Carb. and Magneto Linkage	SAE 30 Oil	60 days	30 days
Clamp Screw	Outboard waterproof gear grease.	60 days	30 days
Roller on Cam Follower	SAE 30 Oil	60 days	30 days

NOTE — "How Often" refers to periods of operation.

TAKING CARE OF YOUR MOTOR

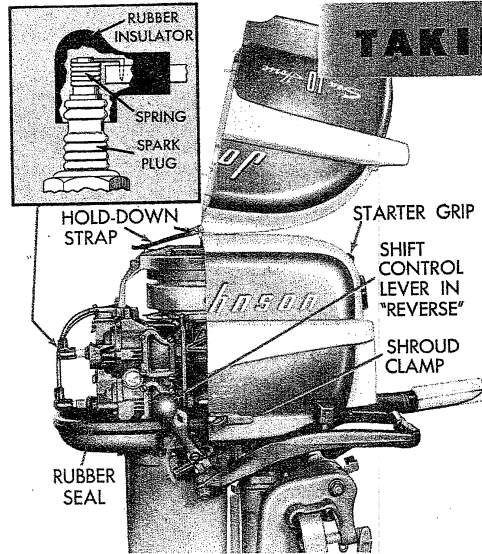

REMOVING MOTOR SHROUD

Move shift lever, without forcing it, to reverse position (out of the way). If lever cannot be moved easily, pull slightly on the starter cord which will allow you to shift. When operating with remote controls, place throttle in EXTREME SLOW position and disconnect remote control cable on the shift lever side of the motor. Release the latches on each side of the shroud and disconnect hold-down strap. Lift rear half of shroud up, move entire shroud forward to clear lugs holding front shroud and lift off. Reinstall shroud assembly in reverse order, making certain rubber seal fits properly between shroud and lower pans before securing latches.

SPARK PLUG RECOMMENDATION AND REPLACEMENT

Using the correct spark plug is most important for efficient operation. The recommended spark plug for your motor is Champion J6J or Auto-Lite A3X. The proper spark plug gap is .030".

Detach rubber covered spark plug terminal (twist slightly counterclockwise and pull off). With wrench provided, remove spark plugs for inspection or replacement as necessary.

When reinstalling spark plug, clean the spark plug seat in cylinder head. Be sure spark plug gasket is in place and tighten plug securely. The spring inside rubber terminal lead cover must be positioned to fit properly over spark plug terminal (see illustration).

COOLING

The motor has a vari-volume water pump for cooling. It operates as a centrifugal pump at high speeds and as a constant displacement pump at low speeds. Water is taken in through the water inlet located on the underside of the exhaust discharge, directly behind the propeller, and is expelled through the underwater exhaust and water discharge.

Check to be sure that a spray of water is coming out of water discharge when operating motor. If water is not being discharged, stop the motor and check the water inlet. Remove any weeds or debris and start the motor. **DO NOT OPERATE MOTOR IF SPRAY OF WATER IS NOT COMING OUT OF DISCHARGE** (see frontispiece). Take the motor to your Johnson dealer.

Do not operate the motor if lower unit drags on the bottom because sand and silt can be forced into pump causing damage and extensive repairs. See Accessory Section for Chrome Pump Housing.

ADJUSTING CARBURETOR LEVERS

Make the following adjustment if the HIGH or SLOW speed adjusting levers are removed or become loose on the shafts.

1. Remove screws and HIGH and SLOW speed adjusting levers from shafts.
2. Turn slotted high speed shaft to the right, with screw driver, until it seats gently (not too tight). Then turn it left $\frac{3}{4}$ turn.
3. Turn slotted slow speed shaft to the right, with screw driver, until it seats gently (not too tight). Then turn it left 2 turns.
4. Replace the lever so pointers are set between No. 3 and 4. Be sure the shaft position is not changed. Replace screws and tighten securely while holding levers in position.

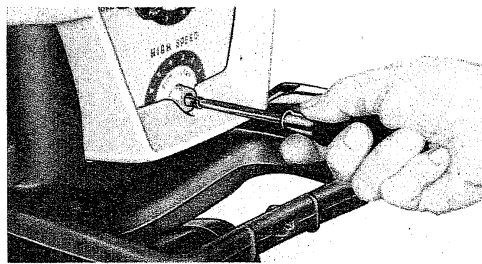

MOTORS DROPPED OVERBOARD (Not Running)

1. Recover motor from water immediately, if possible.
2. Remove shroud, HIGH and SLOW SPEED knobs, choke knob and control panel.
3. Disconnect spark plug leads and remove spark plugs. **CAUTION** — Detach rubber covered spark plug lead covers and ground spark plug lead terminals by attaching them to motor block.
4. Work out as much water as possible by pulling the manual starter grip several times with motor in upright and inverted positions. Pour a small amount of oil through the spark plug hole into each cylinder and pull the manual starter grip several times to distribute the oil.
5. Remove starter housing and flywheel inspection port cover.
6. Blow air through the inspection port to remove water from magneto. Wipe magneto dry with a clean cloth, being sure no water stays between contact points.
7. Remove high speed needle to drain carburetor bowl. **CAUTION** — Loosen needle packing nut before removing needle.
8. Reassemble parts you removed and follow starting instructions.

9. If motor fails to start, remove spark plugs again to see if water is present between electrodes.

Blow out any water from between electrodes and reinstall or replace with new ones. If the motor still fails to start **HAVE IT SERVICED IMMEDIATELY**. (When away from home, refer to your Service Station Listing). Motors which have been submerged must be started or disassembled as soon as possible or expensive repairs will be necessary. To minimize damage, motor must be started or serviced within approximately 3 hours after recovering.

MOTORS DROPPED OVERBOARD (Running)

Follow the same procedure as Motors Dropped Overboard (Not Running). However, if there is any binding when flywheel is rotated (by pulling manual starter grip) it indicates a bent connecting rod and no attempt should be made to start the motor. **HAVE IT SERVICED IMMEDIATELY**.

MOTORS DROPPED OVERBOARD (In Salt Water)

Follow same procedure as Motors Dropped Overboard (Not Running) and (Running) but take the motor to your Johnson dealer as soon as possible, even if it can be started, as salt water can cause excessive corrosion of magneto and internal parts.

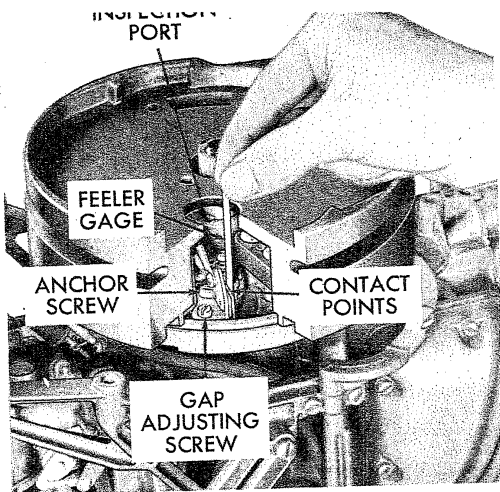

MAGNETO POINTS ADJUSTMENT

After extended use it may be necessary to adjust the magneto breaker points. The gap between the points should be set to .020 inches using the feeler gauge provided. Proceed as follows:

1. Remove the shroud (page 16).
2. Remove the three screws attaching starter assembly and lift it off.
3. Remove the inspection port cover from flywheel.
4. Turn flywheel until one set of points can be seen through inspection port in flywheel.
5. Loosen the anchor screw. Turn adjusting screw left or right until feeler gage binds slightly between the points. Retighten the anchor screw.
6. Follow same procedure to adjust the other set of points.
7. Reassemble parts removed.

CLEANING MAGNETO POINTS

1. Follow Steps 1 to 4 inclusive under "Magneto Points Adjustment".
2. Wash each set of contact points with carbon tetrachloride.
3. Reassemble the parts removed.

TAKING CARE OF YOU

CLEANING FUEL FILTER

If inspection shows sediment accumulation in glass bowl proceed as follows: (See Carburetor Exploded View)

Before removing filter obtain a new filter bowl gasket from your Johnson dealer. Disconnect fuel supply line from motor.

1. Loosen the filter bowl nut and remove the glass bowl.
2. Remove filter element by unscrewing knurled nut.
3. Wash filter element and bowl thoroughly in clean gasoline.
4. Assemble in the reverse order as described above. A new filter bowl gasket should be used; however, if new gasket is not available, use old gasket until new one can be obtained.
5. Tighten filter bowl nut securely.

CLEANING CARBURETOR FLOAT CHAMBER

1. Remove the shroud (page 16).
2. Remove the choke knob, HIGH and SLOW speed levers and control panel.
3. Remove the two screws holding the air silencer.
4. Unscrew the two nuts on the carburetor mounting flange and pull carburetor forward as the nuts are loosened to provide clearance.
5. Depress the clamp on the fuel line and disconnect the line from the carburetor.
6. Remove the fuel filter (page 18).
7. Remove the five screws holding the float chamber.
8. Take out the hinge pin, float, float valve, seat and gasket.

9. Clean the float chamber and component parts with fresh gasoline. Blow out fuel passages with compressed air (if available).
10. Reassemble the parts as illustrated. Be sure the hinge on the float is toward the bottom. Use new gaskets if old ones are damaged.

CARBURETOR EXPLODED VIEW

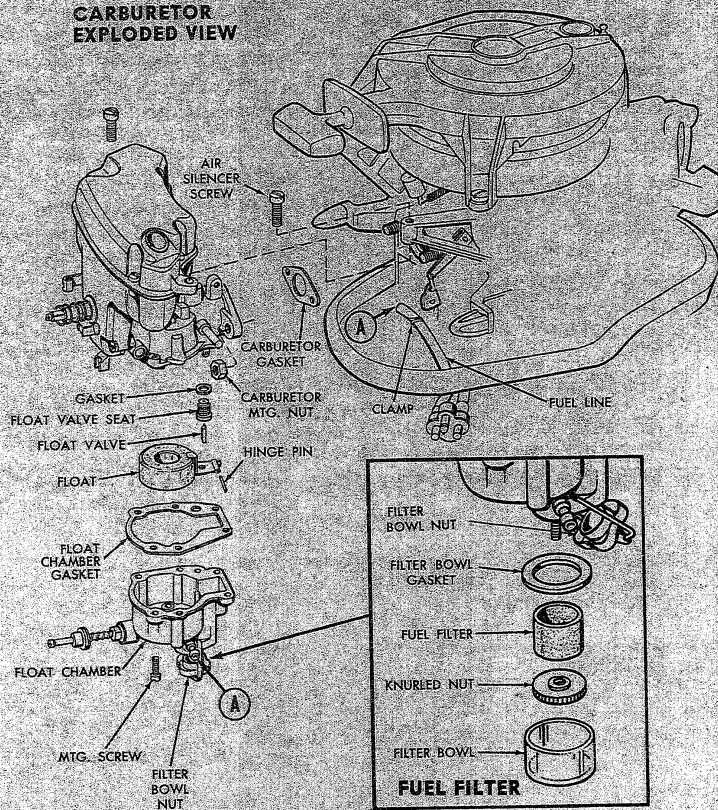

THREE POINT CHECK LIST

Your motor has been precisely engineered, assembled and tested for you to enjoy many hours of pleasant boating. However, as with any operating mechanism, it's possible to have some problems. If you have difficulty starting, or if the motor does not operate properly, only three things have to be checked — spark, fuel and compression — the three things which make it run.

HARD STARTING

CHECK YOUR FUEL SYSTEM FOR

Fuel in tank — Tank connection to motor — Proper carburetor adjustment — Carburetor primed — Choke pulled out — Proper fuel mixture — Loose fuel tank cap (Tighten) — Water in the fuel (Drain and refill with fresh fuel mixture) — Fuel tank resting on fuel line — Partially clogged fuel tank screen or fuel filter.

CHECK YOUR IGNITION SYSTEM FOR

Proper position of speed control — Loose electrical connections — Spark plugs carboned, burned, or wet — Improper type spark plugs — Incorrect gap in spark plugs — Incorrect gap in magneto points.

IF MOTOR WON'T START

CHECK YOUR FUEL SYSTEM FOR

Fuel in tank — Fuel in carburetor (Be sure to prime it) — Clogged fuel line — Water in fuel (Drain and refill with fresh fuel mixture).

CHECK YOUR IGNITION SYSTEM FOR

Faulty spark plugs (Clean and adjust gap or replace) — Corroded magneto points (Clean and adjust or replace if necessary) — Disconnected spark plug leads.

IF MOTOR DOESN'T RUN SMOOTHLY

CHECK YOUR FUEL SYSTEM FOR

Proper fuel mixture — Carburetor adjustment — Fresh fuel — Water in fuel (Drain and refill with fresh fuel mixture) — Partially clogged fuel lines, filter, fuel tank screen. Loose fuel tank cap (Tighten).

CHECK YOUR IGNITION SYSTEM FOR

Loose ignition connections — Faulty spark plugs — Incorrect gap in spark plugs — Improper type spark plugs — Incorrect gap in magneto points — If proper contact between magneto points. If your motor doesn't run properly after checking the above list, take it to your Johnson dealer for service.

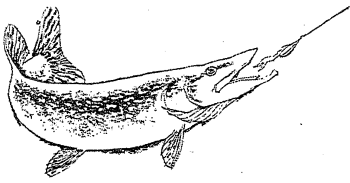

CHECK COMPRESSION

Pull manual starter grip slowly to determine whether or not your motor has good compression. Faulty compression can be caused by loose spark plugs. Be sure there is a gasket under spark plugs and that they are tight. If compression is still faulty and fuel system and ignition are working properly, take motor to your Johnson dealer for service check-up.

CHECK COMPRESSION

If fuel and ignition system are functioning properly, check compression as under "Hard Starting".

CHECK COMPRESSION

If fuel and ignition system are functioning properly, check compression as under "Hard Starting".

BEFORE STORING YOUR MOTOR

It's best to have your Johnson dealer service your motor prior to off-season storage. However, if you want to do it yourself, proceed as follows. Operate your motor in a test tank or on the boat with shift lever in neutral at approximately $\frac{1}{2}$ throttle, pull choke and leave it out until motor stops. This will lubricate and protect internal parts of the power head while motor is in storage. If the motor was last operated in salt water, we recommend it be run in fresh water before preparing it for storage.

1. Place motor on a stand in upright position. Remove the shroud (Page 16).
2. Retard throttle all the way and slowly pull the manual starter grip several times to drain water from the water pump.
3. Drain and clean the carburetor float chamber, filter bowl and fuel line. (Page 19). Drain and clean fuel tank.
4. Remove the propeller. Clean and lubricate the shaft. Replace the drive pin if bent or worn.
5. Wipe over the entire external surface of the motor with a cloth soaked in light oil.
6. Store motor in an upright position in a dry and well ventilated room. To prevent accidental starting, retard throttle all the way.

AFTER STORING — BEFORE USING

If you have properly stored your motor follow these suggestions.

1. Remove and check spark plugs (See page 16). Clean or replace if necessary.
2. Check lower unit lubrication (See page 14).
3. Remove propeller and have it checked by your Johnson Dealer. A slightly off-pitch propeller blade can rarely be distinguished on casual observation but will affect the performance of your motor.
4. Thoroughly clean any surfaces that need refinishing and touch up. Obtain paint from your Johnson dealer.
5. If possible, check motor in a test tank.

EQUIPMENT FOR YOUR BOAT

If you intend to operate on navigable waterways, consult your local U. S. Coast Guard Office regarding current regulations governing your craft. If there is any doubt concerning regulations in your locality, write to U. S. Coast Guard Headquarters, Washington 25, D. C., Small Boats Numbering Division.

You are required by law to have the following equipment aboard:

1. A U. S. Coast Guard approved life jacket or "approved" buoyant cushion for each person aboard.
2. If over 16 ft. long, a warning device (mouth operated horn or whistle).
3. An approved type fire extinguisher. Outboard motorboats less than 26 feet in length of open construction, not carrying passengers for hire, are not required to carry fire extinguishers.
4. A combination light in the forepart of the boat, showing red to port, green to starboard, from right ahead to two points abaft the beam, visible for 1 mile. A white light aft showing all around the horizon, visible for 2 miles.

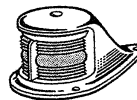
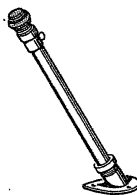
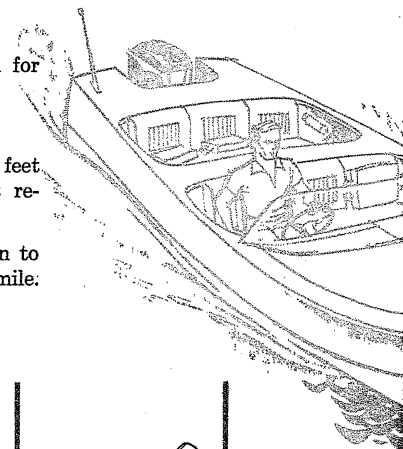

HOW TO GET PEAK PERFORMANCE

Once you learn how to operate and maintain your motor you'll want to know what you can do to get smoother operation, better gas consumption and better performance from your boat. This section gives you a few hints to help you do this.

PROPELLER

This is the only part of your motor that transmits horsepower into miles per hour. The propeller furnished with your motor is the best for average operations, however, under special conditions you may wish to change propellers.

On a light boat with light loads, a propeller with an increase in pitch from standard might be desirable. On a heavy boat with heavy loads use a propeller with less pitch than standard. Motors used for skiing and twin motor installation on cruisers would get best results with a propeller of about 1" less pitch than standard. In high altitudes use a propeller with less pitch. It is recommended that a tachometer be used in making propeller changes so as to keep the r.p.m. within the specifications of your motor. (See Specifications Chart). Check with your Johnson dealer before deciding what propeller to use.

TRANSOM HEIGHT

If the transom is too high the propeller will operate in turbulent water with lowered efficiency and poor cooling may result. If the transom is too low, excessive drag may result and your boat will not perform properly. Transom height should be as specified on page 6.

ANGLE ADJUSTMENT

The proper angle of tilt for the motor depends on the type of boat and load distribution. In the initial adjustment, if motor is mounted on boat which is not in the water, the cavitation plate of the motor should be parallel to the planing section of the bottom. If the lower unit is tilted too far forward the boat will plane on too much of its length and the bow will dig,

which can be dangerous when in rough water with a following sea. If the lower unit is too far out it will result in cavitation and loss of speed. Cavitation may also be caused by a bent propeller, weeds or other material caught on the propeller and gearcase, or an improperly designed keel. (See page 6). Another cause for loss in performance is moss or barnacles (primarily in salt water) collecting on the boat bottom.

CARBURETOR ADJUSTMENT

How to make the carburetor adjustments is described on pages 11 and 23. The carburetor setting may have to be changed due to changes in temperature, altitude, humidity, gasoline and other factors. In order to conserve fuel, adjust the carburetor toward the lean side. When adjusting the HIGH SPEED adjusting lever turn it toward the lean side until you hear a definite lowering of r.p.m.'s and your boat speed slows down. Then gradually turn lever toward RICH until boat speed increases and r.p.m.'s increase to a point at which the motor runs properly.

The SLOW SPEED lever should be adjusted so motor operates smoothly at slow speeds.

GASOLINE

Always use fresh gasoline. Gasoline which has been in a tank for a long period of time (several weeks) may cause spark plug failure and give you carburetor trouble. If you are having spark plug trouble, use white Marine gasoline, or change to a different brand of regular gasoline, if white Marine gasoline is not available. It may be necessary to try several brands to prevent spark plug trouble.

REMOTE CONTROLS

When installing remote controls be sure the throttle can be opened completely.

**SHIP MASTER
REMOTE CONTROL**

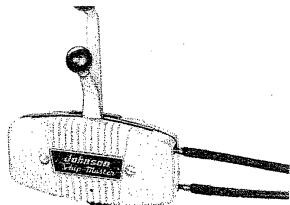

Applies to all models except 3 H.P. (Model JW).
Johnson Ship Master Remote Control is precision engineered for your Johnson Sea Horse motor. Dependable controls are tough and corrosion resistant for smooth, positive action. The Twin-Type Remote Control unit is equipped with two speed control levers and two shift levers. Levers can be moved together or separately so that motors operate as one unit, or individually. Johnson Sea Horse 5½ H.P. (Model CD) or 7½ H.P. (Model AD) can be adapted for remote control with the easily installed Remote Control Installation Kit.

TRANSOM PLATE

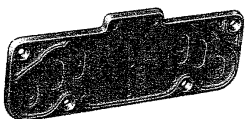

Applies to all models
Protect your boat transom with metal transom plate. One model fits all Johnson Sea Horse motors.

**REMOTE CONTROL
ADAPTER KIT**

Applies to 5½ H.P. (Model CD) and 7½ H.P. (Model AD).
Adapt your Johnson Sea Horse 5½ H.P. (Model CD) or 7½ H.P. (Model AD) for remote control! Use these easily installed kits.

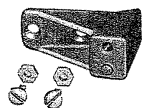

**SINGLE
FUEL SYSTEM**

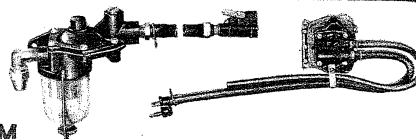

Applies to 18 H.P. Std (Model FD), 18 H.P. Elec (Model FDE), 35 H.P. Std (Model RD), 35 H.P. Elec (Model RDE) and Javelin Elec (Model RJE).
The Fuel-Master System package includes a diaphragm-operated fuel pump, filter-primer unit with mounting flange, single fuel line connector, flexible neoprene tubing with fittings. Fuel tanks are not included ... this is left up to the builder or owner. You can hook up the Fuel-Master System simply and perfectly; just follow the clear, illustrated instructions included with the kit.

**TWIN
FUEL SYSTEM**

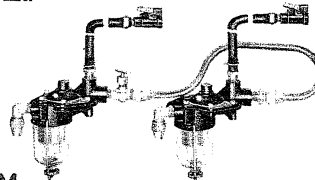

Applies to 18 H.P. Std (Model FD), 18 H.P. Elec (Model FDE), 35 H.P. Std (Model RD), 35 H.P. Elec (Model RDE) and Javelin Elec (Model RJE).
Install the Fuel-Master System on your twin motor outboard cruiser! Simply use a Fuel-Master package for each motor, and connect filter-primer units with the Twin Fuel System Fuel Valve, Half Union and Fuel Line. Connect to either one or more fuel tanks.

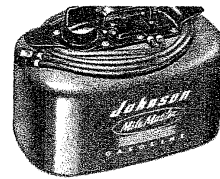

MILE-MASTER TANK

Applies to all models except 3 H.P. (Model JW).
 If you want extra fuel capacity the Mile-Master tank is available in 4 1/4 and 6 gallon sizes. The 4 1/4 tank has a 6 ft. fuel line and the 6 gallon tank has a 12 ft. fuel line.

CHOKE AND START PLATE — TWIN

Applies to 18 H.P. Elec (Model FDE), 35 H.P. Elec (Model RDE) and Javelin Elec (Model RJE).

This attractive and colorful plate provides for mounting two choke buttons and two start buttons. The plastic medallion in the center can be removed for installation of an ammeter when a generator is used.

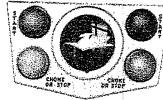

CARRYING HANDLE

Applies to 10 H.P. (Model QD), 18 H.P. Std (Model FD), and 18 H.P. Elec (Model FDE).

The carrying handle is designed for your motor and is easily installed to aid in carrying your Johnson 10 H.P. (Model QD) or 18 H.P. (Models FD or FDE).



CHROME PUMP HOUSING

Applies to all models except 3 H.P. (Model JW).
 If you use your motor in sandy or silty water a chrome pump housing can be obtained from your Johnson Dealer. The chrome pump housing is of chrome brass construction and will not be affected by salt water and gives you longer pump life.



STEERING HANDLE

Applies to 35 H.P. Elec (Model RDE) and Javelin Elec (Model RJE).

Steering handles are available for your Johnson Sea Horse 35 H.P. Electric (Model RDE) or Javelin Electric (Model RJE) Motor. Handles can be quickly and easily installed. Installation instructions are included with steering handle.

MOTOR STAND

Applies to all models

An easy way to care for your Sea Horse Motor — place it on a Johnson Motor Stand for storage and maintenance during idle periods.

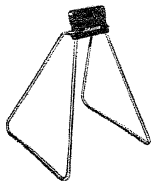

GENERATOR KIT

Applies to 35 H.P. Elec (Model RDE) and Javelin Elec (Model RJE).

To increase battery life and assure positive starting, a generator kit is available for electric starting 35 H.P. Sea-horse motors. All necessary equipment, including wiring, regulator, ammeter gage, etc., are furnished in kit for easy installation.

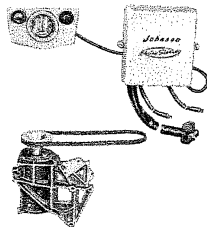

REGISTRATION AND INSURANCE

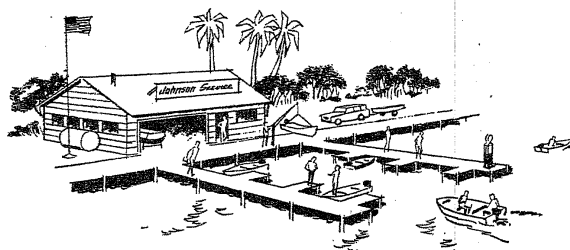

A registration card is to be filled out by your Johnson dealer at the time of purchase. Please supply him with the necessary information so he may properly register your motor.

Insurance on your outboard motor and/or boat should be procured as soon as practicable for protection against loss by fire, theft, etc. Write to Outboard Boating Club of America, 309 North Michigan Avenue, Chicago 1, Illinois for further details, or consult your local insurance agent.

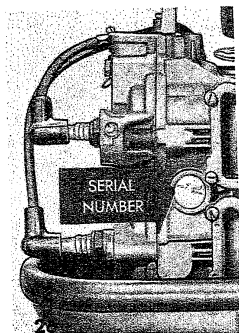

WHERE TO FIND MODEL AND SERIAL NUMBER

The model and serial number are stamped on a nameplate attached to the stern bracket as illustrated. The serial number is also stamped on a plug located on the starboard (left side facing front of motor) side of the cylinder.

Additional copies available — 30¢ each.

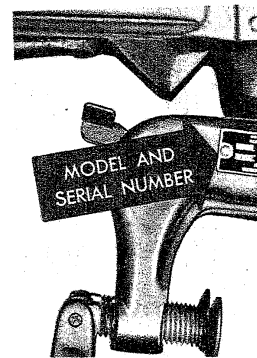

WARRANTY

We warrant each new outboard motor of our manufacture to be free from defects in material and workmanship under normal use and service, our obligation under this warranty being limited to making good at the factory any part or parts thereof which shall, within three months after initial use, or within one year from date of original purchase, whichever first occurs, be returned to us with transportation charges prepaid, and which our examination shall disclose to our satisfaction to have been thus defective; this warranty being expressly in lieu of all other warranties and representations expressed or implied and of all other liabilities in connection with the sale or use of any motors.

This warranty shall not apply to any motor which shall have been repaired or altered outside the factory in any way so as to affect its stability, nor which has been subject to misuse, negligence or accident, or operated for racing purposes or operated in any other way than in accordance with our operating instructions. Nor does the warranty extend to repairs made necessary by the use of accessories not recommended by Johnson Motors.

We make no warranty in respect to trade accessories not of our manufacture, inasmuch as they are usually warranted separately by their respective manufacturers.

To make a claim under this warranty, contact the dealer from whom motor was originally purchased or the nearest authorized Johnson dealer. Motors or parts thereof shipped to the factory for our inspection must show model and serial numbers, and must be shipped transportation charges prepaid.

